

P SERIES FIBER LASER CUTTING MACHINE FOR METAL SHEET

With all-around protective covering and double exchange tables



With all-around protective covering and double exchange tables

The equipment meets the parts processing requirements of most industries, working accuracy is stable. Selecting the optimal force and supporting structure, the overall mechanical property of equipment is perfect. Adopting cutting-edge optical concept to improve cutting performance. High speed cutting, auxiliary loading and unloading and efficient production reduce labor costs. At present, laser cutting machines have been widely used in electronics, electrical, mechanical hardware, new energy lithium, packaging, solar, LED, automotive and other industries.

Product parameters

| Model | P3015 | P4020 | P6020 | P6025 | P8025 |
|---------------------------------|--|-------------|-------------|-------------|-------------|
| Working Area | 3000*1500mm | 4000*2000mm | 6100*2000mm | 6100*2500mm | 8100*2500mm |
| Laser Power | 40000w/30000w/20000w/15000w/12000w/8000w/6000w/4000w/3000w/2000w/1500w/1000w | | | | |
| X/Y-axis Positioning Accuracy | 0.03mm | | 0.05mm | | |
| X/Y-axis Repositioning Accuracy | 0.02mm | | 0.03mm | | |
| Max. linkage speed | 140m/min | | | | |

Version number 2020 10.26
(Above data is only for reference)

Higher Safety Level

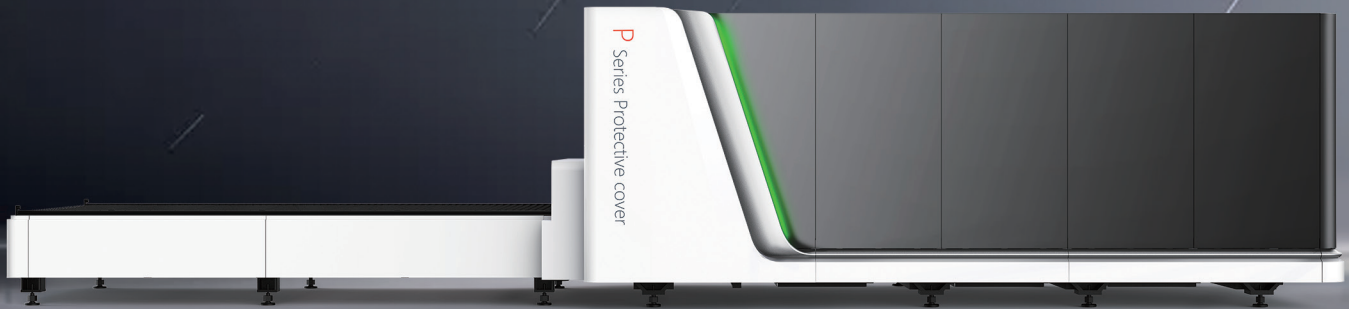

All Cover Exchange Platform Laser Cutting Machine — P Series

- The all-around protective covering isolates laser radiation and pollution, offering higher safety level.
- Smoke and dust produced during cutting will be automatically collected to ensure a clean operating area.
- Smart monitoring system helps reduce accident rate.

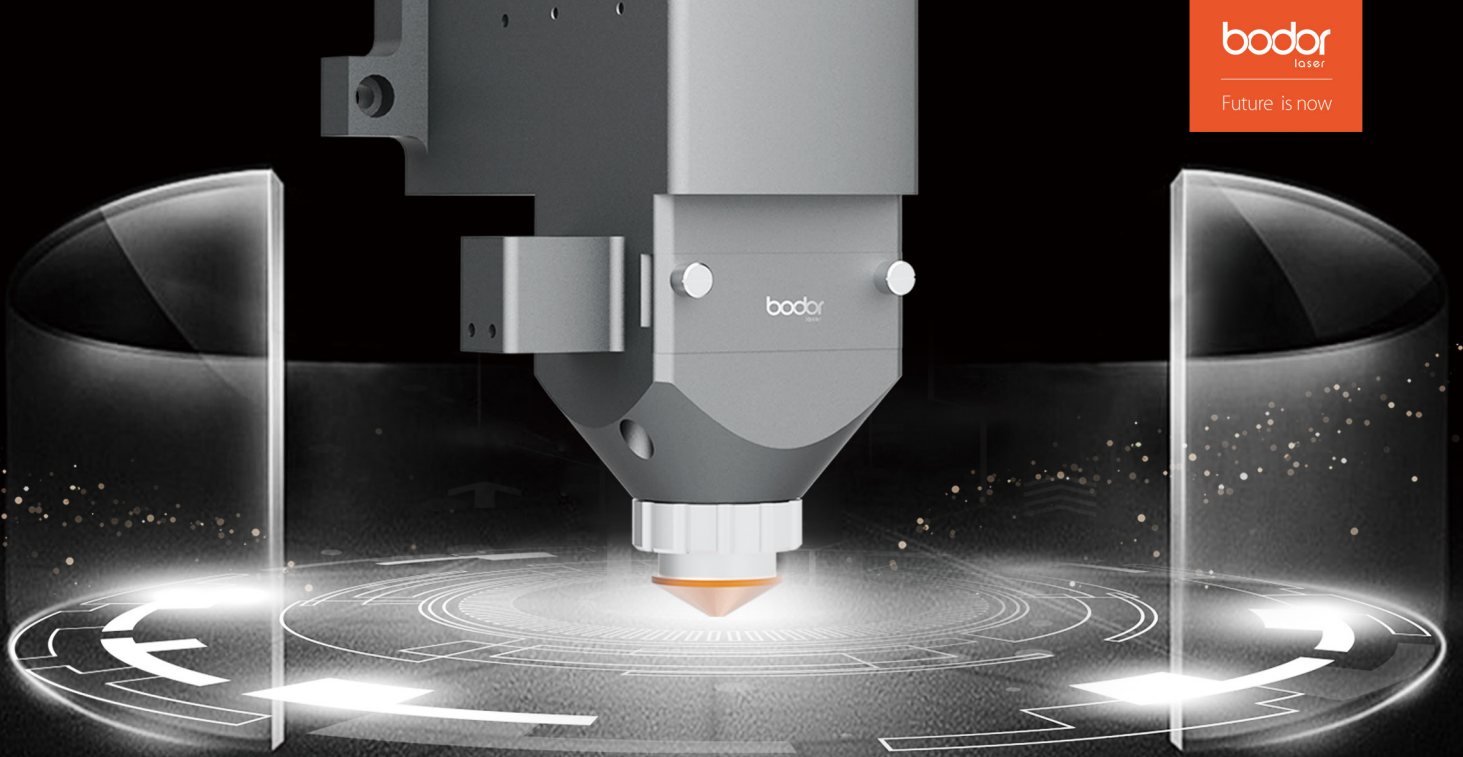

Auto-focusing Laser Head

Auto-focusing

Applicable to multiple focal lengths, automatically adjusts focal position in cutting process by different sheet thickness.

Bodor Lightning Perforation Technology

Suitable for multiple focal lengths, and focal position will be automatically adjusted based on thickness of different sheets. Focal length is controlled by operating system, avoiding errors and deviations caused by manual operation.

Accurate

By setting perforation focal length and cutting focal length respectively, the cutting is more accurate.

Durable

By increasing collimation & focus protective lens, the key components can be protected. Built-in double water-cooling structure ensures constant temperature of collimating and focusing components, prevents lenses from overheating and prolongs service life of lenses.



Cast Iron Bed

A CAST IRON BED LAST FOREVER

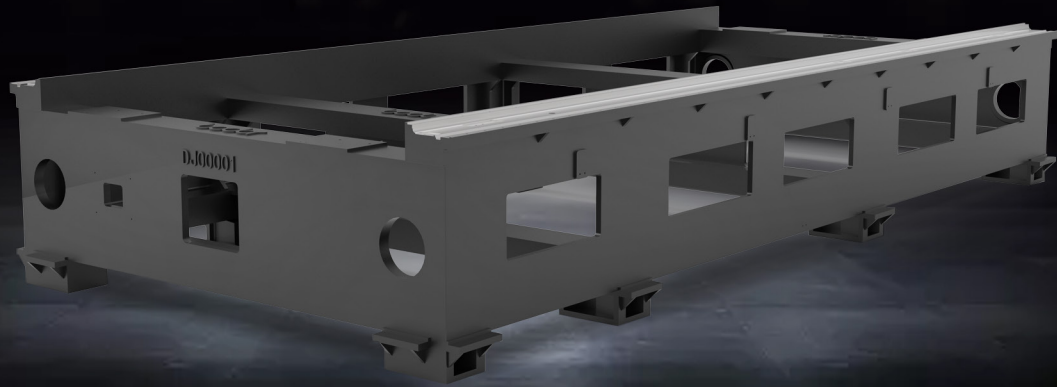

Material is more suitable



Technique is more suitable

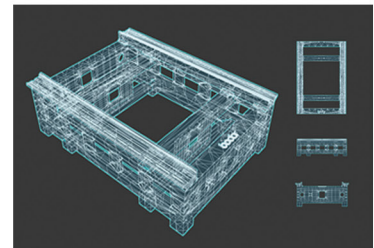

Structure is more reasonable

Clone production

- Pouring Mold, clone production; integrally formed, reject splicing.

Durable

- The usage of flake graphite with the lowest tensile strength of 200MPa gives the whole equipment strong shock absorption, wear resistance, high hardness, high carbon content, high compressive strength.
- Low notch sensitivity and thermal sensitivity of cast iron bed reduces the loss of equipment in using, keeps the precision of cutting unchanged permanently and no deformation in its life cycle.

Unique Anti-burning Mechanism Of Table And Bed Surface

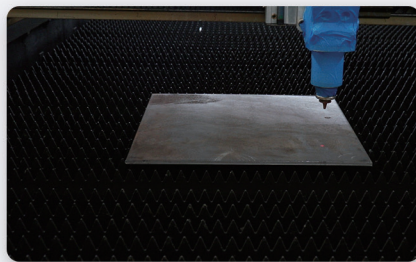

Unique anti-burning mechanism of table and bed surface(above 6kW)

- The table adopts the way of cast iron plate cushion backing the copper plate to absorb cutting heat and prevent table from being damaged.
- The bed surface is covered with additional cast iron plates to prevent the bed from being damaged by the falling material and cutting splash.



Rapid Smoke Exhaust



Rapid smoke exhaust (V2.0)

The newly upgraded smoke extraction system re-analyzes the equipment air duct structure, optimizes the air duct structure, the true power of the fan, and passes various rigorous dust removal and smoke exhaust tests, which can be achieved even in the face of complex smoke exhaust requirements exhaust smoke quickly.

bodor

Automatic Obstacle Avoidance



Intelligent anti-collision

360°radar system can detect any obstacles in advance, and Z axis high-speed motion will be activated to immediately avoid obstacles, avoiding collisions.



Higher Efficiency, Lower Cost

This function Lowers the damage rate of laser head, and accordingly reduces maintenance cost, prolonging service life of the machine. Avoid production halt caused by collisions, ensuring continuous production.

Stretched Aluminum Beam



Stretched Aluminum Beam(V2.0)

- High-strength inner cavity design gives anti-deformation quality, effectively dispersing internal and external stress.
- Adopt aviation aluminum ultra-high pressure stretching process to acquire anti-twisting and anti-overturning qualities, achieving optimal mechanical performance.
- Greatly improved rigidity of the gantry beam and the light weight ensure high speed, high precision, and high responsiveness.

Double Fast Exchange Tables

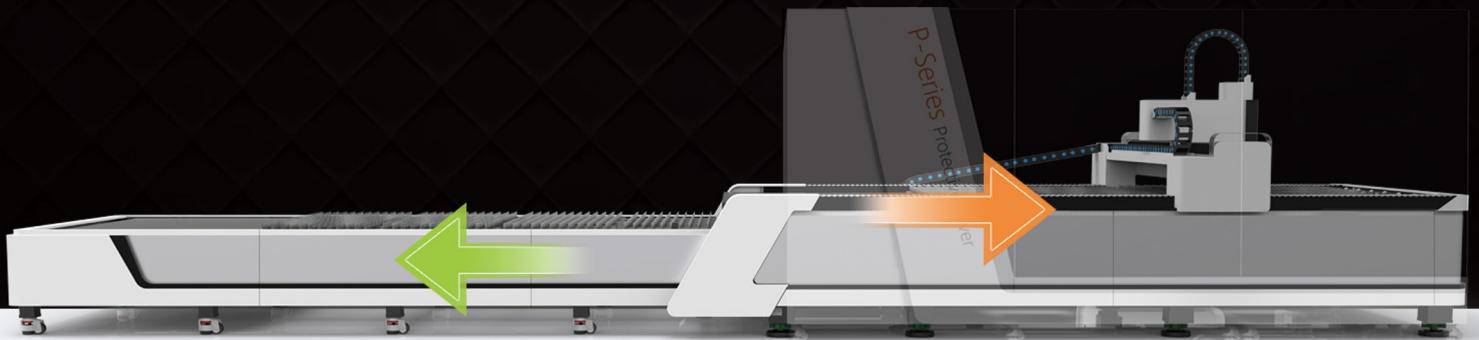

Double Fast Exchange Tables

Fast exchange of two tables greatly improves efficiency.

Rack and gearwheel transmission system has better rigidity and higher accuracy, saving feeding time.



MANGO

Mango wireless remote control handle

Mango wireless remote control handle

Mango shape, elegant curve, use with one hand, magnetic attraction design.





21.5-INCH SCREEN

21.5-inch Screen

21.5-inch screen offers larger display area.

Bodor Pro Operating System



Bodor pro

Bodor's independent R&D operating system can realize intelligent layout of graphics. Use optimal logic programming and software interactions in control aspect to achieve stunning using experience, effectively improve utilization of sheet metal and reduce leftover material.

More Practical Ultimate Experience



Unique anti-burning mechanism of table and bed surface

- The newly optimized table load-bearing capacity(the full format is 30mm carbon steel when the power is below 6kw.
- The full format 40mm carbon steel when 6kw and above), it is not afraid of thick plate processing.
- Cantilever type rotatable mobile console, flexibly adapt to the processing needs of different scenes.
- The large enclosure is integrated with the bed, which simplifies on-site installation and is beautiful and smooth..

Auxiliary Gas Low Pressure Alarm Function

Auxiliary Gas Low Pressure Alarm Function

Providing real-time pressure detection and reporting abnormal information ensure cutting effect, precision and timely replace gas.

FUNCTIONS

The heavy bed makes the equipment more stable in working, the light crossbeam makes it work faster; perfect industrial design is more in line with man-machine engineering; high quality electrical software control system gives equipment higher cutting precision. The machine owns more comfortable operation, more stable performance, more durable quality, higher cutting efficiency and wider application scope.

Safety Following Module

Laser head is kept in a safe distance from the material during cutting. And laser head will stop its motion once colliding with the sheet, reducing collision risks.

Automatic lubrication system

Quantitative lubricants provided for equipment guarantee the normal and high-speed operation, greatly improving the cutting accuracy.

The function of abnormal liquid level alarm can effectively extend the service life of the transmission mechanism.

Cutting Capacity

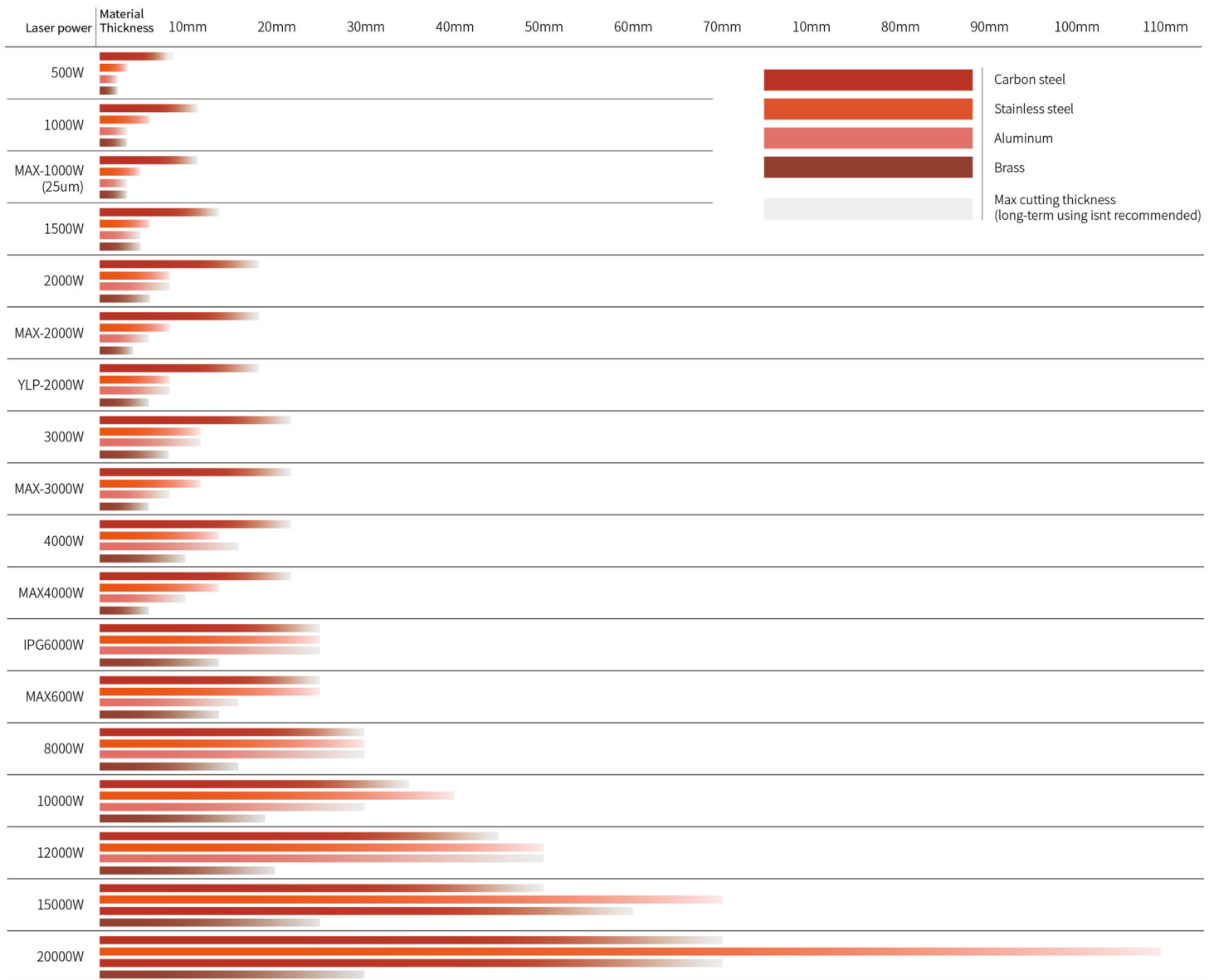

Above data is only for reference

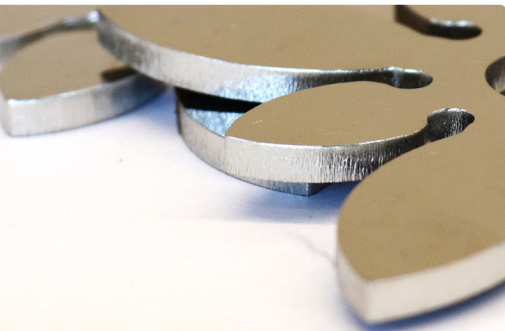
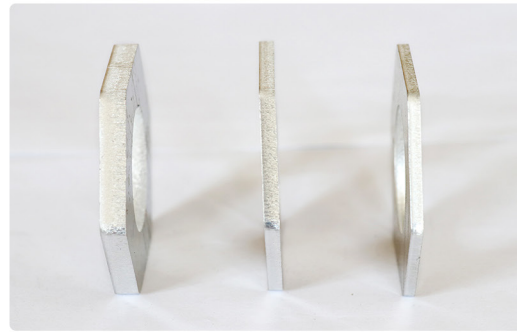
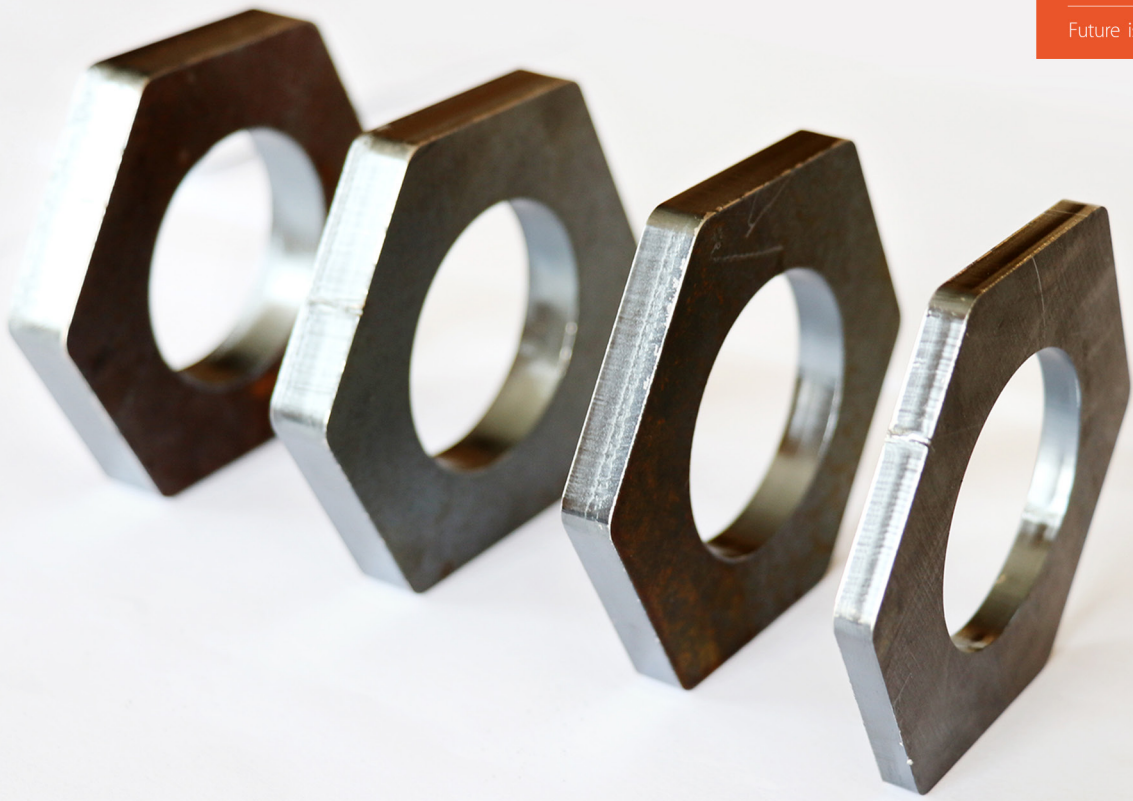

Metal Samples

For more information, please go to the website : www.bodor.com



OFFICE

For more information, please go to the website : www.bodor.com

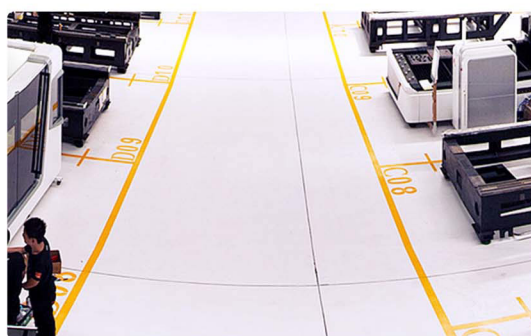

WORKSHOP

For more information, please go to the website : www.bodor.com