

La Sélection

Accessoires de cuisine ^{et} en salle

Valable jusqu'au 31 DÉCEMBRE 2024



ACCESSOIRES
DE CUISINE

ET

EN

SALLE



SOMMAIRE



ACCESSOIRES DE CUISINE

| | |
|---|-------------|
| LA CUISSON..... | P. 4 à 15 |
| LA DÉCOUPE..... | P. 16 à 25 |
| LA PRÉPARATION..... | P. 26 à 47 |
| LES CONTENANTS GASTRONORMES..... | P. 48 à 49 |
| LA RÉCEPTION, LE STOCKAGE & LA MANUTENTION..... | P. 50 à 58 |
| LA DISTRIBUTION..... | P. 59 à 65 |
| LA VENTE À EMPORTER & L'USAGE UNIQUE..... | P. 66 à 73 |
| L'HYGIÈNE..... | P. 74 à 91 |
| LE TEXTILE | P. 92 à 109 |

EN SALLE

| | |
|-----------------------------|--------------|
| LA VAISSELLE..... | P. 110 à 151 |
| LES COUVERTS | P. 152 à 159 |
| LA VERRERIE..... | P. 160 à 177 |
| LES ACCESSOIRES | P. 178 à 191 |
| L' ACCUEIL..... | P. 192 à 199 |
| LE BAR | P. 200 à 205 |
| LES ACCESSOIRES BUFFET..... | P. 206 à 214 |
| L'USAGE UNIQUE | P. 215 à 219 |
| LE TEXTILE | P. 220 à 226 |

INDEX ALPHABÉTIQUEP.227

INDEX PAR REFERENCEP.232

L'ENVIRONNEMENT

FEEL GREEN

Ligne Feel Green fabriquée à l'aide de matières premières recyclées et/ou respectueuses de l'environnement.



Certificats UNE-EN ISO 900:2015, système de gestion de la qualité qui démontre notre capacité à proposer des produits qui répondent aux exigences et prérequis des clients ainsi qu'aux réglementations applicables. N° de registre 0.04.04392.



Etiqueté EU Ecolabel, qui garantit le respect des critères sélectifs et transparents sur le comportement environnemental des produits.



Règlement (CE) n° 1223/2009 du Parlement Européen et du Conseil, du 30 Novembre 2009, sur les produits cosmétiques



Des produits fabriqués avec des matériaux respectueux de l'environnement, recyclables et/ou compostables.

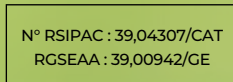

Registre Général Sanitaire pour les Entreprises Alimentaires et les Aliments.



Articles en papier imprimés à l'aide d'encre compostables.



Grande variété de produits avec certificat ECOLABEL (indiqué dans le catalogue), qui garantit un niveau élevé de protection de l'environnement tout au long du cycle de vie du produit, N° de registre ES-CAT/004/006.



Circuit fermé de réutilisation des encres et recyclage de tous les restes de papier, plastique et carton.



Choix de matériaux qui répondent aux exigences de biodégradation et pour l'impression flexographique avec des encres compostables "OK COMPOST".



Système d'épuration d'eau.



Produits respectueux de l'environnement, fabriqués à partir de papier 100% recyclé et / ou encres compostables.



Sélection de fabricants de papier et carton FSC ou PEFC, Certificats qui garantissent la provenance de forêts gérés de manière responsable et durable de ces produits, Nous choisissons également des fournisseurs avec certificat ISO14001 (Système de Gestion de l'Environnement),

FICHE TECHNIQUE DES MATÉRIAUX UTILISÉS

| Matière | Tolérance thermique | Micro-ondes | Four | Congélateur | Résistant aux huiles et graisses | Biodégradable | Recyclable |
|--|---|----------------|------|----------------------|----------------------------------|---------------|--------------------|
| Polyéthylène Téréphtalate PET / APET / RPET | -18° C +70° C | X | X | ✓ | ✓ | X | ✓ |
| Polyéthylène de haute densité | -60° C +110° C | ✓ | X | ✓ | ✓ | X | ✓ |
| Polychlorure de vinyle | -20° C +60° C | X | X | ✓ | ✓ | X | ✓ |
| Polyéthylène de basse densité | -60° C +80° C | ✓ | X | ✓ | ✓ | X | ✓ |
| Polypropylène | -10° C +120° C | ✓ | X | ✓ | ✓ | X | ✓ |
| Polystyrène cristal | -10° C +85° C | X | X | ✓ | ✓ | X | X (PS Métalliques) |
| Polystyrène orienté | -40° C +80° C | X | X | ✓ | ✓ | X | ✓ |
| Polystyrène expansé (FOAM) | -20° C +100° C | X | X | X | ✓ | X | ✓ |
| Polycarbonate | -10° C +100° C | X | X | ✓ | ✓ | X | ✓ |
| Styrene Acrylonitrile | -10° C +90° C | X | X | ✓ | ✓ | X | ✓ |
| Mélamine | -10° C +70° C | X | X | ✓ | ✓ | X | ✓ |
| Méthacrylate | -40° C +85° C | X | X | ✓ | ✓ | X | ✓ |
| Acide polylactique PLA / CPLA | PLA -20° C +40° C CPLA -20° C -90° C | X ✓ | X | ✓ | ✓ | ✓ | X |
| Aluminium | -40° C +280° C | X ✓ (laque) | ✓ | ✓ | ✓ | ✓ | ✓ |
| Bois | -18° C +200° C | ✓ | ✓ | ✓ | ✓ | ✓ | ✓ |
| Feuilles/Fogli/Leaf | -5° C +70° C | X | ✓ | ✓ | ✓ | ✓ | ✓ |
| Bambou | -5° C +70° C | X | X | X | ✓ | ✓ | ✓ |
| Feuille de palmier Areca | -18° C +180° C | ✓ | ✓ | ✓ | ✓ | ✓ | ✓ |
| Papier | -40° C +180° C | ✓ | ✓ | X ✓ (cisé/laminé) | X ✓ (Ingraisable) | ✓ | X ✓ (Métallisé) |
| Carton | -40° C +90° C | ✓ | ✓ | X ✓ (cisé/laminé) | X ✓ (Ingraisable) | ✓ | X ✓ (Métallisé) |
| Canne à sucre / Bagasse | -18° C +150° C | ✓ | ✓ | X | ✓ | ✓ | ✓ |
| Porcelaine | -20° C +160° C | ✓ | ✓ | ✓ | ✓ | X | X |
| Grès | 0° C +70° C | ✓ | X | ✓ | ✓ | X | X |
| Verre | -30° C +100° C | ✓ | X | ✓ | ✓ | X | ✓ |
| Borosilicate | -30° C 300° C | ✓ | ✓ | ✓ | ✓ | X | ✓ |
| Faïence | -20° C +200° C | ✓ | ✓ | ✓ | ✓ | X | X |
| Cellophane | 0° C +70° C | X | X | X | ✓ | ✓ | ✓ |

TABLE DE SYMBOLES

- Recyclable
 - Reutilisable
 - Compostable
 - Apte à usage alimentaire
 - Anti-bactérien
 - Four
 - Gaz
 - Vitrocéramique
 - Induction
 - Electrique
- Adapté au micro-ondes P.U. Prix unitaire



PRIMA MATERA

Composés de 90% de cuivre et 10% d'acier inoxydable, les ustensiles de la gamme PRIMA MATERA possèdent une conductibilité thermique optimale pour une maîtrise parfaite de la cuisson. Fabriqué en France, leur fond spécial en inox ferromagnétique permet une utilisation sur tous types de feu, même induction.



| Faitout cuivre à couvercle | 📦 | | P.U |
|----------------------------|---|--------|---------|
| Ø 20 cm | 1 | 202101 | 352,18€ |
| Ø 24 cm | 1 | 202102 | 460,99€ |
| Ø 28 cm | 1 | 202103 | 532,94€ |



| Sautoir cuivre à couvercle | 📦 | | P.U |
|----------------------------|---|--------|---------|
| Ø 20 cm | 1 | 202109 | 280,22€ |
| Ø 24 cm | 1 | 202111 | 352,76€ |
| Ø 28 cm | 1 | 202113 | 466,84€ |



| Casserole cuivre | 📦 | | P.U |
|------------------|---|--------|---------|
| Ø 14 cm | 1 | 202104 | 172,00€ |
| Ø 16 cm | 1 | 202105 | 214,12€ |
| Ø 18 cm | 1 | 202106 | 268,52€ |
| Ø 20 cm | 1 | 202107 | 304,21€ |
| Ø 24 cm | 1 | 202108 | 406,58€ |



| Sauteuse droite cuivre | 📦 | | P.U |
|------------------------|---|--------|---------|
| Ø 16 cm | 1 | 202114 | 195,98€ |
| Ø 20 cm | 1 | 202115 | 250,39€ |
| Ø 24 cm | 1 | 202116 | 358,61€ |



| Sautoir bombe cuivre à couvercle | 📦 | | P.U |
|----------------------------------|---|--------|---------|
| Ø 28 cm | 1 | 202117 | 413,02€ |



| Pâte à polir bistro polycuivre | 📦 | | P.U |
|--------------------------------|---|--------|--------|
| 150 ml | 6 | 220311 | 14,05€ |



AFFINITY

Les ustensiles de la gamme Affinity sont composés d'un matériau innovant hyper conducteur en acier inoxydable multicouches (5 couches) qui permet une cuisson homogène tout en préservant les vitamines des aliments. Idéal pour la cuisine de réduction, les sauces.



| Faitout à couvercle | | P.U |
|---------------------|---|----------------|
| Ø 16 cm | 1 | 202096 104,31€ |
| Ø 20 cm | 1 | 202097 127,68€ |
| Ø 24 cm | 1 | 202098 157,32€ |
| Ø 28 cm | 1 | 202099 181,83€ |



| Sautoir à couvercle | | P.U |
|---------------------|---|----------------|
| Ø 24 cm | 1 | 202093 136,80€ |
| Ø 28 cm | 1 | 202094 164,16€ |
| Ø 20 cm | 1 | 202092 109,44€ |



| Sautoir bombé à couvercle | | P.U |
|---------------------------|---|----------------|
| Ø 28 cm | 1 | 202095 170,43€ |



| Sauteuse droite | | P.U |
|-----------------|---|----------------|
| Ø 16 cm | 1 | 202195 74,67€ |
| Ø 20 cm | 1 | 202196 92,34€ |
| Ø 24 cm | 1 | 202197 112,29€ |
| Ø 28 cm | 1 | 202198 134,52€ |



| Casserole | | P.U |
|-----------|---|----------------|
| Ø 14 cm | 1 | 202084 68,97€ |
| Ø 16 cm | 1 | 202085 76,38€ |
| Ø 18 cm | 1 | 202086 86,64€ |
| Ø 20 cm | 1 | 202087 96,90€ |
| Ø 24 cm | 1 | 202088 108,87€ |



| Poêle ronde | | P.U |
|-------------|---|----------------|
| Ø 20 cm | 1 | 205073 69,54€ |
| Ø 24 cm | 1 | 205074 79,23€ |
| Ø 28 cm | 1 | 205075 90,06€ |
| Ø 32 cm | 1 | 205076 108,87€ |



| Sauteuse bombée | | P.U |
|-----------------|---|---------------|
| Ø 20 cm | 1 | 202193 87,21€ |
| Ø 24 cm | 1 | 202194 94,05€ |



| Wok 2 anses | | P.U |
|-------------|---|----------------|
| Ø 32 cm | 1 | 205081 148,77€ |



| Couvercle inox bombé PR | | P.U |
|-------------------------|---|---------------|
| Ø 14 cm | 1 | 205058 19,38€ |
| Ø 16 cm | 1 | 205059 20,52€ |
| Ø 18 cm | 1 | 205060 21,66€ |
| Ø 20 cm | 1 | 205061 23,37€ |
| Ø 24 cm | 1 | 205062 26,79€ |
| Ø 28 cm | 1 | 205063 37,62€ |



| Plat à rôtir trimétal | | P.U |
|-----------------------|---|----------------|
| 35 x 25 cm | 1 | 205082 139,65€ |



ALCHIMY

La gamme Alchimy, fabriquée 100% en France, est la combinaison parfaite entre les exigences des Chefs et les besoins des cuisiniers au quotidien. Sa conception monobloc 3 couches assure une répartition des températures régulière et la maîtrise des cuissons même les plus délicates. Cette conception réduit la consommation d'énergie. Facile d'entretien, sain et durable.



| Casserole | Icon | P.U |
|-----------|------|---------------|
| Ø 14 cm | 1 | 202461 60,85€ |
| Ø 16 cm | 1 | 202462 67,28€ |
| Ø 18 cm | 1 | 202463 74,88€ |
| Ø 20 cm | 1 | 202464 81,32€ |
| Ø 24 cm | 1 | 202465 87,75€ |



| Poele à frire | Icon | P.U |
|---------------|------|---------------|
| Ø 20 cm | 1 | 202470 60,85€ |
| Ø 24 cm | 1 | 202471 67,87€ |
| Ø 28 cm | 1 | 202472 74,88€ |
| Ø 32 cm | 1 | 202473 87,75€ |



| Sauteuse à queue Bord droit | Icon | P.U |
|-----------------------------|------|----------------|
| Ø 24 cm | 1 | 202466 87,75€ |
| Ø 28 cm | 1 | 202467 102,38€ |



| Faitout | Icon | P.U |
|---------|------|----------------|
| Ø 16 cm | 1 | 202474 73,71€ |
| Ø 20 cm | 1 | 202475 86,58€ |
| Ø 24 cm | 1 | 202476 100,63€ |
| Ø 28 cm | 1 | 202477 108,23€ |



| Cuit-vapeur Inox | Icon | P.U |
|------------------|------|---------------|
| Ø 24 cm | 1 | 202478 29,20€ |



| Sauteuse à queue Bombée | Icon | P.U |
|-------------------------|------|---------------|
| Ø 16 cm | 1 | 202468 66,70€ |
| Ø 24 cm | 1 | 202469 81,32€ |



| Couvercle en verre avec pontet Inox | Icon | P.U |
|-------------------------------------|------|---------------|
| Ø 14 cm | 1 | 202480 15,16€ |
| Ø 16 cm | 1 | 202481 18,08€ |
| Ø 18 cm | 1 | 202482 19,25€ |
| Ø 20 cm | 1 | 202483 19,83€ |
| Ø 24 cm | 1 | 202484 21,59€ |
| Ø 28 cm | 1 | 202486 22,76€ |
| Ø 32 cm | 1 | 202485 23,35€ |



| Wok | Icon | P.U |
|---------|------|----------------|
| Ø 32 cm | 1 | 202479 114,08€ |



INOX-PRO

Corps en acier inoxydable 18/10. Rayons intérieurs qui permettent un entretien facile et rapide. Anses en acier inox conçues pour une utilisation facile et résistantes à la chaleur. Intérieur et extérieur poli satiné. Triple fond thermo-diffuseur type sandwich (inox-alu-inox).



| Marmite | 🔑 | P.U | Faitout | 🔑 | P.U | Couvercle | 🔑 | P.U |
|----------------------------|---|-----------------------|------------------------------|---|-----------------------|-----------|---|----------------------|
| Ø 16 cm - H 16 cm - 3 L | 1 | 201756 27,73€ | Ø 16 cm - H 7,5 cm - 1,5 L | 1 | 201768 23,63€ | Ø 16 cm | 1 | 201216 7,01€ |
| Ø 18 cm - H 18 cm - 4,5 L | 1 | 201757 35,47€ | Ø 18 cm - H 8 cm - 2 L | 1 | 201769 27,60€ | Ø 18 cm | 1 | 201218 7,86€ |
| Ø 20 cm - H 20 cm - 6,2 L | 1 | 201758 36,69€ | Ø 20 cm - H 8 cm - 2,5 L | 1 | 201770 28,75€ | Ø 20 cm | 1 | 201220 8,87€ |
| Ø 24 cm - H 24 cm - 10 L | 1 | 201759 42,16€ | Ø 24 cm - H 9,5 cm - 4,3 L | 1 | 201771 30,39€ | Ø 24 cm | 1 | 201224 9,32€ |
| Ø 28 cm - H 28 cm - 16,5 L | 1 | 201760 61,19€ | Ø 28 cm - H 11 cm - 6,7 L | 1 | 201772 42,67€ | Ø 28 cm | 1 | 201228 10,72€ |
| Ø 30 cm - H 30 cm - 21,2 L | 1 | 201761 83,37€ | Ø 30 cm - H 12 cm - 8,4 L | 1 | 201773 55,85€ | Ø 30 cm | 1 | 201700 11,31€ |
| Ø 32 cm - H 32 cm - 24 L | 1 | 201762 89,45€ | Ø 32 cm - H 12,5 cm - 10 L | 1 | 201774 56,61€ | Ø 32 cm | 1 | 201232 13,54€ |
| Ø 35 cm - H 35 cm - 33,6 L | 1 | 201763 112,09€ | Ø 35 cm - H 14 cm - 13,6 L | 1 | 201775 74,84€ | Ø 35 cm | 1 | 201236 16,19€ |
| Ø 40 cm - H 40 cm - 50 L | 1 | 201764 136,99€ | Ø 40 cm - H 15,5 cm - 19,5 L | 1 | 201776 82,17€ | Ø 40 cm | 1 | 201240 19,60€ |
| Ø 45 cm - H 45 cm - 72 L | 1 | 201765 176,67€ | Ø 45 cm - H 17 cm - 27 L | 1 | 201777 103,57€ | Ø 45 cm | 1 | 201245 22,86€ |
| Ø 50 cm - H 50 cm - 98 L | 1 | 201766 263,18€ | Ø 50 cm - H 20 cm - 39 L | 1 | 201778 140,97€ | Ø 50 cm | 1 | 201250 27,68€ |
| Ø 60 cm - H 55 cm - 155 L | 1 | 202009 384,95€ | Ø 60 cm - H 23 cm - 65 L | 1 | 201753 217,44€ | Ø 60 cm | 1 | 202716 40,03€ |



| Braisière | 🔑 | P.U | Sautoir | 🔑 | P.U | Plaque à rôtir | 🔑 | P.U |
|------------------------------|---|-----------------------|---------------------------|---|-----------------------|----------------|---|----------------------|
| Ø 16 cm - H 11 cm - 2,1 L | 1 | 201780 26,03€ | Ø 20 cm - H 6 cm - 1,9 L | 1 | 201792 26,49€ | 40 x 30 cm | 1 | 213540 67,17€ |
| Ø 18 cm - H 12 cm - 3 L | 1 | 201781 29,22€ | Ø 24 cm - H 6 cm - 2,7 L | 1 | 201793 29,78€ | 50 x 40 cm | 1 | 213550 85,17€ |
| Ø 20 cm - H 13 cm - 4 L | 1 | 201782 31,80€ | Ø 28 cm - H 6 cm - 3,7 L | 1 | 201794 43,10€ | | | |
| Ø 24 cm - H 14 cm - 6,3 L | 1 | 201783 34,56€ | Ø 30 cm - H 6 cm - 4,3 L | 1 | 201795 46,16€ | | | |
| Ø 28 cm - H 17,5 cm - 10,2 L | 1 | 201784 46,16€ | Ø 32 cm - H 6 cm - 4,7 L | 1 | 201796 55,06€ | | | |
| Ø 30 cm - H 18 cm - 12,7 L | 1 | 201785 56,49€ | Ø 35 cm - H 7 cm - 6,7 L | 1 | 201797 70,56€ | | | |
| Ø 32 cm - H 19 cm - 15,2 L | 1 | 201786 59,11€ | Ø 40 cm - H 8 cm - 10 L | 1 | 201798 79,14€ | | | |
| Ø 35 cm - H 21 cm - 20,2 L | 1 | 201787 79,99€ | Ø 45 cm - H 8,5 cm - 12 L | 1 | 201799 90,41€ | | | |
| Ø 40 cm - H 25 cm - 31,4 L | 1 | 201788 100,20€ | Ø 50 cm - H 9 cm - 17,5 L | 1 | 201800 129,85€ | | | |
| Ø 45 cm - H 28 cm - 44,50 L | 1 | 201789 116,16€ | | | | | | |
| Ø 50 cm - H 30 cm - 59 L | 1 | 201790 162,54€ | | | | | | |
| Ø 60 cm - H 35 cm - 99 L | 1 | 201754 255,68€ | | | | | | |



INOX-PRO

Corps en acier inoxydable 18/10. Rayons intérieurs qui permettent un entretien facile et rapide. Anses en acier inox conçues pour une utilisation facile et résistantes à la chaleur. Intérieur et extérieur poli satiné. Triple fond thermo-diffuseur type sandwich (inox-alu-inox).



| Sauteuse droite | ☛ | P.U |
|------------------------------|---|----------------------|
| Ø 20 cm - H 6 cm - 1,9 L | 1 | 204020 24,64€ |
| Ø 24 cm - H 6 cm - 2,7 L | 1 | 204024 27,75€ |
| Ø 28 cm - H 6 cm - 3,7 L | 1 | 204028 40,71€ |
| Ø 32 cm - H 6 cm - 4,7 L | 1 | 204032 48,58€ |
| Casserole forme française | ☛ | P.U |
| Ø 12 cm - H 7 cm - 0,7 L | 1 | 201017 18,79€ |
| Ø 14 cm - H 7 cm - 1 L | 1 | 201019 21,01€ |
| Ø 16 cm - H 7,5 cm - 1,5 L | 1 | 201016 22,42€ |
| Ø 18 cm - H 9 cm - 2,3 L | 1 | 201018 25,06€ |
| Ø 20 cm - H 10 cm - 3,1 L | 1 | 201020 27,15€ |
| Ø 24 cm - H 12 cm - 5,4 L | 1 | 201024 33,64€ |
| Ø 28 cm - H 14 cm - 8,6 L | 1 | 201028 45,22€ |
| Casserole haute bain-marie | ☛ | P.U |
| Ø 16 cm - H 11 cm - 2,1 L | 1 | 202791 23,72€ |
| Ø 18 cm - H 12 cm - 3 L | 1 | 202792 25,65€ |
| Ø 20 cm - H 13 cm - 4 L | 1 | 202793 28,29€ |
| Ø 24 cm - H 14 cm - 6,3 L | 1 | 202794 33,83€ |
| Ø 28 cm - H 17,5 cm - 10,2 L | 1 | 202795 47,34€ |

EN ALUMINIUM

Poignées ergonomiques et légèreté de la matière. Les casseroles sont recouvertes d'un antiadhésif. Fond plaque inox à induction.



| Poêle aluminium antiadhésive | ☛ | P.U |
|------------------------------|---|----------------------|
| Ø 20 cm | 1 | 203799 14,02€ |
| Ø 24 cm | 1 | 203800 18,01€ |
| Ø 28 cm | 1 | 203801 20,76€ |
| Ø 32 cm | 1 | 203802 24,56€ |

PROFESSIONNELLE ANTI-ADHÉSIVE

Idéale pour mijoter, réchauffer, cuisiner et réapproprier les mets pré-cuisinés.



| Poêle antiadhésive | ☛ | P.U |
|--------------------|---|----------------------|
| Ø 24 cm | 1 | 299478 34,70€ |
| Ø 28 cm | 1 | 299479 43,08€ |
| Ø 32 cm | 1 | 299480 49,11€ |
| Ø 36 cm | 1 | 299481 69,62€ |

EXPERT



| Poêle | ☛ | P.U |
|---------|---|----------------------|
| Ø 20 cm | 1 | 202242 26,14€ |
| Ø 24 cm | 1 | 202243 29,29€ |
| Ø 28 cm | 1 | 202244 34,74€ |
| Ø 32 cm | 1 | 202245 41,82€ |
| Ø 36 cm | 1 | 202246 53,30€ |
| Ø 40 cm | 1 | 202247 62,45€ |

TRIBUTE®

La poêle Tribute® triple couches, extrêmement durable offre une distribution parfaite de la chaleur. Frire, sauter ou saisir, cette poêle à induction avec revêtement antiadhésif haut de gamme CeramiGuard, offre un démoulage souple et un nettoyage facile. Le nouveau manche offre un toucher froid et une prise ergonomique plus confortable. Système Ever-Tite contre les rivets desserrés.

NOUVEAUTÉ !



| Poêle multi-métal anti-adhésive | ☛ | P.U |
|---------------------------------|---|----------------------|
| Ø 18 cm | 1 | 202961 41,76€ |
| Ø 20 cm | 1 | 202962 43,26€ |
| Ø 24 cm | 1 | 202963 50,08€ |
| Ø 28 cm | 1 | 202964 66,62€ |
| Ø 32 cm | 1 | 202965 83,59€ |



PRIM'APPETY

Gamme professionnelle en acier inoxydable. Fond magnétique épais pour une répartition parfaite de la chaleur sur tout le fond. Finition satinée poli brossé, bord verseur et garnitures tube soudées. Hygiène parfaite de l'inox avec un entretien facile.

| Casserole | 📦 | P.U |
|-----------|---|----------------------|
| Ø 12 cm | 1 | 206615 14,93€ |
| Ø 14 cm | 1 | 206616 16,68€ |
| Ø 16 cm | 1 | 206617 18,44€ |
| Ø 18 cm | 1 | 206618 21,65€ |
| Ø 20 cm | 1 | 206619 23,99€ |
| Ø 24 cm | 1 | 206620 29,25€ |
| Ø 28 cm | 1 | 206621 41,54€ |



| Sauteuse bombée | 📦 | P.U |
|-----------------|---|----------------------|
| Ø 16 cm | 1 | 206625 16,38€ |
| Ø 18 cm | 1 | 206626 17,55€ |
| Ø 20 cm | 1 | 206627 21,95€ |
| Ø 24 cm | 1 | 206628 28,38€ |
| Ø 28 cm | 1 | 206629 37,74€ |



| Sauteuse droite | 📦 | P.U |
|-----------------|---|----------------------|
| Ø 20 cm | 1 | 206622 21,06€ |
| Ø 24 cm | 1 | 206623 25,16€ |
| Ø 28 cm | 1 | 206624 33,35€ |



| Poêle | 📦 | P.U |
|---------|---|----------------------|
| Ø 20 cm | 1 | 206630 24,87€ |
| Ø 24 cm | 1 | 206631 27,21€ |
| Ø 28 cm | 1 | 206632 33,35€ |
| Ø 32 cm | 1 | 206633 46,52€ |

| Faitout sans couvercle | 📦 | P.U |
|------------------------|---|-----------------------|
| Ø 20 cm | 1 | 206634 25,74€ |
| Ø 24 cm | 1 | 206635 31,89€ |
| Ø 28 cm | 1 | 206636 43,01€ |
| Ø 32 cm | 1 | 206637 55,29€ |
| Ø 36 cm | 1 | 206638 80,73€ |
| Ø 40 cm | 1 | 206639 98,28€ |
| Ø 45 cm | 1 | 206640 118,17€ |
| Ø 50 cm | 1 | 206641 156,20€ |

| Marmite sans couvercle | 📦 | P.U |
|------------------------|---|-----------------------|
| Ø 20 cm | 1 | 206642 33,93€ |
| Ø 24 cm | 1 | 206643 43,29€ |
| Ø 28 cm | 1 | 206644 67,28€ |
| Ø 32 cm | 1 | 206645 88,64€ |
| Ø 36 cm | 1 | 206646 111,74€ |
| Ø 40 cm | 1 | 206647 128,42€ |
| Ø 45 cm | 1 | 206648 161,46€ |
| Ø 50 cm | 1 | 206649 318,54€ |



TEIDE

Poêle en fonte d'aluminium dotée d'un revêtement antiadhésif de haute qualité, offrant une cuisson sans accroc et un nettoyage facile. Cette poêle vous permet de cuisiner avec aisance tout en préservant la saveur naturelle de vos ingrédients. Son fond plat la rend compatible avec une variété de sources de chaleur, y compris les plaques à induction.



| Poêle induction | Manche en inox 3 mm. | 📦 | P.U |
|-----------------|----------------------|---|----------------------|
| Ø 20 cm | | 1 | 206685 11,12€ |
| Ø 24 cm | | 1 | 206686 14,12€ |
| Ø 28 cm | | 1 | 206687 16,85€ |
| Ø 32 cm | | 1 | 206688 20,79€ |

USSON

Poêle avec un manche en acier recouvert de résine EPOXY, pour protéger contre la rouille et les températures élevées.



| Poêle induction | Manche en inox 3 mm. | 📦 | P.U |
|-----------------|----------------------|---|----------------------|
| Ø 20 cm | | 1 | 206689 12,68€ |
| Ø 24 cm | | 1 | 206690 16,01€ |
| Ø 28 cm | | 1 | 206691 18,78€ |
| Ø 32 cm | | 1 | 206692 22,50€ |



POÊLE ACIER MINERAL B PRO

Produit écologique recyclable durable

Le fer est un matériau minéral 100 % naturel. Finition protectrice à base de cire d'abeilles biologique. Garanti sans revêtement (ni PFAO, ni PTFE). Pas de composant chimique ajouté. Processus de fabrication respectueux de l'environnement. Produit écologique, recyclable et durable. Santé : les molécules de fer composant la poêle contribuent à conserver une bonne santé. La poêle atteint de hautes températures. Saisis rapidement, les aliments conservent ainsi vitamines et apports nutritifs. Idéal pour saisir, dorer, griller. Culottage : plus la poêle est utilisée, meilleure est la cuisson. Plus elle est noire, moins elle attache. Produit écologique recyclable durable.



| Poêle grill | Quantité | Code | P.U |
|-------------|----------|--------|--------|
| Ø 26 cm | 1 | 203253 | 37,44€ |
| Ø 32 cm | 1 | 203254 | 49,44€ |



| Poêle | Quantité | Code | P.U |
|---------|----------|--------|--------|
| Ø 20 cm | 1 | 203247 | 24,23€ |
| Ø 24 cm | 1 | 203248 | 29,07€ |
| Ø 26 cm | 1 | 203249 | 33,01€ |
| Ø 28 cm | 1 | 203250 | 40,47€ |
| Ø 32 cm | 1 | 203251 | 44,98€ |
| Ø 36 cm | 1 | 203252 | 59,28€ |



| Poêle paysanne | Quantité | Code | P.U |
|----------------|----------|--------|--------|
| Ø 24 cm | 1 | 203255 | 41,25€ |
| Ø 32 cm | 1 | 203256 | 61,13€ |

NOUVEAUTÉ !



| Poêle à omelette En acier | Quantité | Code | P.U |
|------------------------------|----------|--------|--------|
| Ø 24 cm | 1 | 206653 | 42,12€ |
| Ø 28 cm | 1 | 206652 | 47,97€ |



| Poêle à crêpes | Quantité | Code | P.U |
|----------------|----------|--------|--------|
| Ø 24 cm | 1 | 203257 | 23,35€ |
| Ø 26 cm | 1 | 203258 | 29,19€ |
| Ø 30 cm | 1 | 203259 | 32,77€ |



| Poêle à blinis | Quantité | Code | P.U |
|----------------|----------|--------|--------|
| Ø 12 cm | 5 | 203260 | 12,82€ |



| Wok à queue Petit fond plat | Quantité | Code | P.U |
|--------------------------------|----------|--------|--------|
| Ø 24 cm | 1 | 201626 | 28,09€ |
| Ø 28 cm | 1 | 201627 | 35,98€ |



| Wok à queue avec anse Petit fond plat | Quantité | Code | P.U |
|---|----------|--------|--------|
| Ø 32 cm | 1 | 201629 | 46,22€ |



| Poêle rectangulaire à anses | Quantité | Code | P.U |
|--------------------------------|----------|--------|--------|
| 38 x 26 cm - Grill | 1 | 201601 | 64,06€ |
| 38 x 26 cm - Lisse | 1 | 201625 | 57,04€ |



ANTI-ADHÉSIF «CHOC RESTO»

Poêle ronde antiadhésive. Coupe lyonnaise pour faire glisser facilement les aliments. Aluminium épaisseur 5mm : indéformable et grande résistance du revêtement sur induction. Fond rapporté en acier inoxydable ferritique AISI 430 compatible induction. Revêtement haut de gamme composée de 5 couches. HACCP : Queue feuillard rivetée recouverte d'un époxy résistant au flash four (10 min ; 200 °C)



| Poêle queue noire | | P.U | |
|-------------------|---|--------|--------|
| Ø 20 cm | 1 | 202126 | 30,13€ |
| Ø 24 cm | 1 | 202127 | 39,49€ |
| Ø 28 cm | 1 | 202128 | 44,75€ |
| Ø 32 cm | 1 | 202129 | 53,24€ |
| Ø 36 cm | 1 | 202130 | 67,28€ |



| Poêle queue bleue | | P.U | |
|-------------------|---|--------|--------|
| Ø 20 cm | 1 | 202131 | 30,13€ |
| Ø 24 cm | 1 | 202132 | 39,49€ |
| Ø 28 cm | 1 | 202133 | 44,75€ |
| Ø 32 cm | 1 | 202134 | 53,24€ |



| Poêle queue verte | | P.U | |
|-------------------|---|--------|--------|
| Ø 20 cm | 1 | 202140 | 30,13€ |
| Ø 24 cm | 1 | 202141 | 39,49€ |
| Ø 28 cm | 1 | 202142 | 44,75€ |
| Ø 32 cm | 1 | 202143 | 53,24€ |



| Poêle queue rouge | | P.U | |
|-------------------|---|--------|--------|
| Ø 20 cm | 1 | 202136 | 30,13€ |
| Ø 24 cm | 1 | 202137 | 39,49€ |
| Ø 28 cm | 1 | 202138 | 44,75€ |
| Ø 32 cm | 1 | 202139 | 53,24€ |



| Poêle queue jaune | | P.U | |
|-------------------|---|--------|--------|
| Ø 20 cm | 1 | 202144 | 30,13€ |
| Ø 24 cm | 1 | 202145 | 39,49€ |
| Ø 28 cm | 1 | 202146 | 44,75€ |
| Ø 32 cm | 1 | 202147 | 53,24€ |



| Poêle à poisson | | P.U | |
|-----------------|---|--------|--------|
| Ø 35,5 cm | 1 | 206650 | 76,05€ |



ANTI-ADHÉSIF "CHOC"

Queue feuillard rivetée. Revêtement PTFE multicouche enrichi sans PFAO. Résistante à l'abrasion et à la chaleur. Anti-adhérence et glissance optimales.



| Poêle à blinis | ◆ | P.U | |
|----------------|----|--------|--------|
| Ø 12 cm | 10 | 214012 | 13,40€ |
| Ø 14 cm | 10 | 214014 | 15,16€ |



| Poêle à crêpes | ◆ | P.U | |
|----------------|---|--------|--------|
| Ø 26 cm | 5 | 201426 | 19,60€ |
| Ø 30 cm | 5 | 201430 | 23,11€ |



| Poêle à poisson ovale | ◆ | P.U | |
|-----------------------|---|--------|--------|
| 36 cm | 3 | 201536 | 56,17€ |
| 40 cm | 3 | 201540 | 68,45€ |

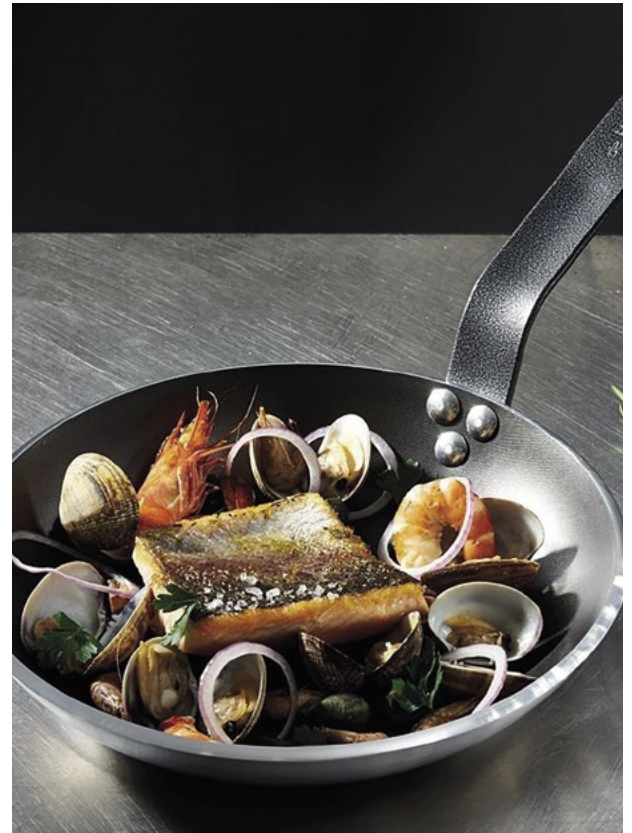

| Poêle à poisson rectangulaire | ◆ | P.U | |
|-------------------------------|---|--------|--------|
| 38 x 26 cm | 3 | 201538 | 77,81€ |

ANTI-ADHÉSIF "CHOC ACCESS"

Gamme en aluminium semi-professionnelle, épaisseur de 3 à 4 mm selon les tailles. Temps de chauffe court, montée régulière en température et diffusion uniforme de la chaleur. Revêtement multicouche de qualité. Coupe lyonnaise et courbure à la française de la queue. Queue feuillard rivetée recouverte d'un époxy résistant aux hautes températures.



| Poêle ronde anti-adhésif | ◆ | P.U | |
|--------------------------|---|--------|--------|
| Ø 20 cm | 3 | 200123 | 15,11€ |
| Ø 24 cm | 3 | 200124 | 17,61€ |
| Ø 28 cm | 3 | 200128 | 20,24€ |
| Ø 32 cm | 3 | 200132 | 23,66€ |
| Ø 36 cm | 3 | 201436 | 38,19€ |
| Ø 40 cm | 3 | 201440 | 43,84€ |



| Plancha rectangulaire réversible Bords relevés avec deux poignées | ◆ | P.U | |
|---|---|--------|---------|
| 50 x 35 cm | 1 | 206651 | 141,00€ |



FONTESTIC

Fontestic fait référence au mot « fonte ». La gamme est conçue avec un intérieur émaillé blanc. Les couvercles sont équipés de petites broches qui répartissent uniformément le liquide de cuisson. Convient à toutes les plaques de cuisson et le four.



| Faitout rond avec couvercle | Jaune | Vert | Rouille | P.U |
|-----------------------------|--------|--------|---------|--------|
| Ø 24 cm - 4,6 L | 206654 | 206655 | 206656 | 71,75€ |
| Ø 28 cm - 6,9 L | 206657 | 206658 | 206659 | 91,46€ |



| Faitout ovale avec couvercle | Jaune | Vert | Rouille | P.U |
|------------------------------|--------|--------|---------|--------|
| 31 x 24 cm | 206660 | 206661 | 206662 | 86,66€ |



| Poêle à griller | Jaune | Vert | Rouille | P.U |
|------------------|--------|--------|---------|--------|
| Ø 28 cm - H 6 cm | 206663 | 206664 | 206665 | 45,90€ |



| Caquelon à fondue | Jaune | Vert | Rouille | P.U |
|-------------------|--------|--------|---------|--------|
| Ø 18 cm | 206666 | 206667 | 206668 | 62,70€ |



| Fourchette pour fondue | P.U |
|------------------------|--------------|
| 25,5 x 13,3 x H 2,5 cm | 206669 7,49€ |

LA CUISSON

Ustensiles

PLAT À PAËLLA

Poêles à paëlla creuses tôle acier. Idéales pour la cuisson professionnelle du riz et de la paëlla.



| Plat à paëlla tôle acier fond martelé 2 anses | Icon | P.U |
|--|------|---------------|
| Ø 60 cm, 22 parts | 1 | 202660 32,34€ |
| Ø 80 cm, 40 parts | 1 | 202680 67,05€ |
| Ø 90 cm, 50 parts | 1 | 202690 88,42€ |

| Brûleur acier émaillé | Icon | P.U |
|-----------------------|------|----------------|
| Ø 35 cm | 1 | 202457 34,71€ |
| Ø 50 cm | 1 | 202458 68,11€ |
| Ø 70 cm | 1 | 202459 184,22€ |



| Trépied pour brûleur Inox | Icon | P.U |
|------------------------------|------|---------------|
| | 1 | 282020 29,70€ |



| Barbecue | Rouille | P.U | Noir | P.U |
|--------------------|---------|----------|--------|----------|
| Ø 99 cm x H 100 cm | 206670 | 1441,70€ | 206671 | 1441,70€ |



| Grille pour brasero | Icon | P.U |
|---------------------|------|----------------|
| Ø 51 cm x H 16 cm | 1 | 206672 131,18€ |



| Brasero | Rouille | P.U | Noir | P.U |
|-------------------|---------|----------|--------|----------|
| 95 x 95 x H 73 cm | 206673 | 1058,07€ | 206674 | 1058,07€ |



| Racleur professionnel | Icon | P.U |
|-----------------------|------|--------------|
| 30 cm | 1 | 206693 7,04€ |

| Lames pour racleur | Icon | P.U |
|--------------------|------|--------------|
| 10 lames | 1 | 206694 2,70€ |



LA DÉCOUPE

Coutellerie

OPÉRA

Cette nouvelle collection haut de gamme est 100% forgée en acier extradur Nitrum renforcé au nitrogène - Les couteaux OPÉRA bénéficient du nouveau fil de lame silk edge d'un angle total de 24° pour une coupe rasoir exceptionnelle et durable à la fois - Fabrication Espagnole



Couteau d'office **P.U**
L 10 cm 1 **200926** 18,65€



Couteau cranté pour citron et tomate **P.U**
L 13 cm 1 **202979** 19,00€



Couteau de cuisine **P.U**
L 14 cm 1 **202977** 24,18€



Couteau à désosser **P.U**
L 14 cm 1 **200933** 27,51€



Couteau Santoku **P.U**
L 18 cm 1 **200930** 32,97€



Couteau Rocking Santoku **P.U**
L 18 cm 1 **200931** 34,52€



Couteau à pain **P.U**
L 18 cm 1 **202980** 30,00€



Couteau de chef **P.U**
L 21 cm 1 **202978** 34,99€



Couteau de chef **P.U**
L 23 cm 1 **200927** 44,13€



Couteau à jambon/saumon **P.U**
L 25 cm 1 **202981** 28,47€



Couteau de chef **P.U**
L 26 cm 1 **200929** 44,98€

UNIVERSAL PRO

Trousse garnie **P.U**
5 couteaux + 1 fusil 1 **206695** 95,62€



SÉRIE FURTIF BASIC

Couteau professionnel FURTIF provient de Thiers, berceau historique de la fabrication de couteaux de cuisine. Couteaux haut de gamme Made In France. En boîte access.



Couteau office **P.U**
9 cm - Lame inox 6 **202227** **24,89€**



Filet de sole **P.U**
17 cm - Lame inox 6 **202224** **28,73€**



Couteau Santoku **P.U**
19 cm - Lame inox 6 **202223** **38,53€**



Couteau chef **P.U**
19 cm - Lame inox 6 **202221** **38,48€**



Couteau de cuisine **P,U**
21 cm - Lame inox 6 **202219** **39,29€**

LICORNE

Collection LICORNE obtenue par moulage d'acier en fusion, manche POM, rivets inox et lame acier inox.



Couteau office **P.U**
9 cm 1 **206684** **10,52€**



Couteau à désosser **P.U**
15 cm 6 **206682** **15,12€**



Filet de sole **P.U**
18 cm 61 **206681** **15,19€**



Couteau Tranchelard **P.U**
25 cm 1 **206678** **21,41€**



Couteau Yatagan **P.U**
20 cm 1 **206679** **15,43€**



Couteau de cuisine **P.U**
15 cm - Lame rigide et large 1 **206677** **16,76€**
20 cm - Lame rigide et large 1 **206676** **18,03€**
25 cm - Lame rigide et large 1 **206675** **21,47€**



Couteau à pain **P.U**
20 cm 1 **206680** **15,43€**



Couteau Légumier **P.U**
13 cm - Lame rigide et dentée 1 **206683** **10,72€**

LA DÉCOUPE

Coutellerie

MAITRE

Manche 3 rivets inox. Lame acier inox NITRUM extradur 57HRC. Angle total 26° coupe rasoir. Garantie 10 ans. Fabrication Espagnole.



| Couteau office | 📦 | P.U |
|----------------|----|---------------------|
| 8 cm | 12 | 204497 6,93€ |
| 10 cm | 12 | 204498 7,01€ |
| 10,5 cm | 12 | 204499 7,24€ |



| Couteau à découper | 📦 | P.U |
|--------------------|----|----------------------|
| 15 cm | 12 | 204501 7,75€ |
| 18 cm | 6 | 204502 10,23€ |
| 22 cm | 6 | 204503 11,08€ |



| Couteau à désosser | 📦 | P.U |
|--------------------|---|----------------------|
| 16 cm | 6 | 204507 10,23€ |



| Couteau filet de sole | 📦 | P.U |
|-----------------------|---|----------------------|
| 17 cm | 1 | 204500 10,78€ |



| Couteau santoku | 📦 | P.U |
|-----------------|---|----------------------|
| 17 cm | 6 | 204508 15,29€ |



| Couteau à pain | 📦 | P.U |
|----------------|---|----------------------|
| 21 cm | 6 | 204506 10,75€ |



| Couteau de cuisine | 📦 | P.U |
|--------------------|---|----------------------|
| 21,5 cm | 6 | 204504 11,90€ |



| Couteau à jambon | 📦 | P.U |
|------------------|---|----------------------|
| 27,5 cm | 6 | 204505 12,13€ |



LA DÉCOUPE

Coutellerie

LAME INOX, MANCHE ABS



| Couteau office cranté | Noir | Rouge | P.U |
|-----------------------|------------------|---------------|--------------|
| 10 cm | 36 200566 | 202229 | 2,36€ |



| Couteau petit déjeuner microcranté | P.U |
|------------------------------------|-------------------------------|
| 10 cm | 36 200934 2,54€ |



| Couteau à pain - Niza | P.U |
|-----------------------|------------------------------|
| 20 cm | 6 204509 7,63€ |



NOVA



| Couteau office | Noir | Vert | Rouge | Bleu | Jaune | Blanc | Marron | Fuchsia | Citron | Menthe | Corail | P.U |
|----------------|------------------|---------------|---------------|---------------|---------------|---------------|---------------|---------------|---------------|---------------|---------------|--------------|
| 6 cm | 36 200563 | 202231 | 202232 | 202233 | 202234 | - | - | - | - | - | - | 2,00€ |
| 8,5 cm | 36 200564 | 202236 | 202237 | 202238 | 202241 | 202239 | - | - | - | - | - | 2,08€ |
| 10 cm | 36 200565 | 202366 | 202367 | 202368 | 202370 | 202369 | 202371 | 202372 | 202373 | 202374 | 202375 | 2,27€ |

LAME INOX, MANCHE ABS



| Coupe-pain sur socle | P.U | Coupe-pain sur socle | P.U |
|----------------------|--------------------------------|----------------------|--------------------------------|
| 44 cm | 1 203004 123,23€ | 35 cm | 1 203006 219,84€ |

| Couteau à pain sur carte | P.U |
|-----------------------------------|------------------------------|
| L 20,5 cm - STUDIO manche polypro | 6 201813 1,97€ |
| L 20,5 cm - ARTISAN manche POM | 6 202305 4,02€ |

En raison d'importantes fluctuations tarifaires, les prix indiqués sont à titres indicatifs et peuvent évoluer. Merci de vous rapprocher de votre Distributeur/Installateur. Prix de vente conseillé.

LA DÉCOUPE

Coutellerie

COLOUR PROF

Couteau HACCP livré avec 6 clips. Le manche de cette série est ergonomique, révolutionnaire, composé d'un noyau dur en polypropylène qui en est le cœur. Il est recouvert d'un caoutchouc spécial, antidérapant, compatible lave-vaisselle. Lame en acier inox NITRUM® et traitement ICE PLUS® Traitement antibactérien BACTIPROOFSILVER®. Fabrication espagnole.



| Couteau office | 📦 | P.U |
|----------------|----|---------------------|
| 8 cm | 12 | 203805 7,21€ |
| 10 cm | 12 | 204510 7,61€ |



| Couteau à saigner | 📦 | P.U |
|-------------------|---|----------------------|
| 13 cm | 6 | 200187 11,17€ |
| 15 cm | 6 | 200188 11,95€ |



| Couteau à désosser | 📦 | P.U |
|--------------------|---|----------------------|
| 13 cm | 6 | 203268 12,01€ |
| 16 cm | 6 | 203269 12,50€ |



| Couteau à désosser | 📦 | P.U |
|--------------------|---|----------------------|
| 15 cm | 6 | 200186 12,13€ |



| Filet de sole | 📦 | P.U |
|---------------|---|----------------------|
| 17 cm | 6 | 200185 12,27€ |



| Couteau de boucher | 📦 | P.U |
|--------------------|---|----------------------|
| 20 cm | 6 | 200178 13,72€ |
| 25 cm | 6 | 200179 16,96€ |
| 30 cm | 6 | 200180 21,39€ |
| 35 cm | 6 | 200181 32,74€ |



| Couteau à jambon (non alvéolé) | 📦 | P.U |
|--------------------------------|---|----------------------|
| 30 cm | 6 | 200938 15,58€ |



| Couteau à dénervier | 📦 | P.U |
|---------------------|---|----------------------|
| 19 cm | 6 | 299707 12,82€ |



| Couteau de cuisine | 📦 | P.U |
|--------------------|---|----------------------|
| 20 cm | 6 | 200182 15,85€ |
| 25 cm | 6 | 200183 17,06€ |
| 30 cm | 6 | 200184 19,30€ |



| Couteau à saumon et jambon alvéolé | 📦 | P.U |
|------------------------------------|---|----------------------|
| 30 cm | 6 | 200191 17,75€ |



| Couteau à génoise | 📦 | P.U |
|-------------------|---|----------------------|
| 30 cm | 6 | 299708 17,75€ |



| Couteau Santoku | 📦 | P.U |
|-----------------|---|----------------------|
| 18 cm | 6 | 200937 21,36€ |

LA DÉCOUPE

Coutellerie

HACCP

Gamme avec traitement anti bactérien bactiproof-silver, lames en acier inoxydable NITRUM. Fabrication Espagnole.

● Viandes crues



| Couteau de boucher | 6 | P.U |
|--------------------|---|---------------|
| 16 cm | 6 | 205123 10,50€ |
| 18 cm | 6 | 205124 11,00€ |
| 21 cm | 6 | 205127 11,70€ |
| 25 cm | 6 | 202124 14,49€ |
| 30 cm | 6 | 205125 16,85€ |



| Couteau à saigner | 6 | P.U |
|-------------------|---|---------------|
| 15 cm | 6 | 205122 10,56€ |



| Couteau tranchelard | 6 | P.U |
|---------------------|---|---------------|
| 19 cm | 6 | 202122 11,77€ |

● Viandes cuites et charcuteries



| Couteau à découper | 6 | P.U |
|--------------------|---|---------------|
| 15 cm | 6 | 205119 8,93€ |
| 16 cm | 6 | 205120 10,50€ |
| 18 cm | 6 | 205121 11,00€ |
| 20 cm | 6 | 205126 11,70€ |



| Couteau à jambon | 6 | P.U |
|------------------|---|---------------|
| 24 cm | 6 | 201006 10,47€ |



| Couteau à parer | 6 | P.U |
|-----------------|---|---------------|
| 25 cm | 6 | 202983 16,66€ |



| Couteau à desosser | 6 | P.U |
|--------------------|---|---------------|
| 14 cm | 6 | 202985 12,01€ |
| 16 cm | 6 | 202984 10,20€ |



| Feuille | 1 | P.U |
|---------|---|---------------|
| 19 cm | 1 | 202982 33,82€ |

● Poissons crus



| Couteau filet de sole | 6 | P.U |
|-----------------------|---|---------------|
| 19 cm | 6 | 202121 11,77€ |

| Couteau à saumon | 6 | P.U |
|------------------|---|---------------|
| 30 cm | 6 | 201005 17,79€ |

| Couteau à poisson | 6 | P.U |
|-------------------|---|---------------|
| 35 cm | 6 | 202123 20,26€ |



LA DÉCOUPE

Coutellerie

SOMMAIRE | INDEX



ARCOS



| Fusil chromé | ● | Noir | P.U |
|--------------|---|---------------|---------------|
| Rond 30 cm | 6 | 202401 | 13,12€ |
| Ovale 30 cm | 6 | 202402 | 23,86€ |



| Fusil diamant | ● | Noir | P.U |
|---------------|---|---------------|---------------|
| Rond 23 cm | 6 | 203512 | 15,46€ |
| Ovale 27 cm | 6 | 202400 | 36,79€ |



| Couteau à abattre inox | ● | P.U |
|------------------------|---|----------------------|
| 27,5 cm | 1 | 200706 48,48€ |



| Feuille parisienne inox | ● | P.U |
|-------------------------|---|----------------------|
| 730 g - 24 cm | 1 | 200770 62,72€ |
| 910 g - 28 cm | 1 | 200785 70,22€ |



| Fusil chromé dur | ● | Bleu | P.U |
|------------------|---|---------------|---------------|
| Rond 30 cm | 6 | 202405 | 27,78€ |
| Ovale 30 cm | 6 | 202407 | 35,63€ |



| Couteau à fromage 2 mains | ● | P.U |
|---------------------------|---|----------------------|
| 29 cm - désaxé | 1 | 204511 39,74€ |
| 40 cm | 1 | 200567 45,22€ |



| Couperet inox | ● | P.U |
|---------------|---|----------------------|
| 400 g - 16 cm | 1 | 200730 26,37€ |
| 600 g - 18 cm | 1 | 200760 31,70€ |



| Pierre à affûter | ● | P.U |
|------------------|---|---------------------|
| | 1 | 201702 8,36€ |



| Boucher, lame alveolée | ● | P.U |
|------------------------|---|----------------------|
| 23 cm | 1 | 206698 26,58€ |



| Berceuse inox, 2 lames | ● | P.U |
|------------------------|---|----------------------|
| 30 cm | 1 | 232350 47,32€ |



| Couteau à fromage/foie gras | ● | P.U |
|-----------------------------|---|----------------------|
| Lame 14,5 cm | 1 | 200743 36,43€ |



| Couteau à fromage 1 main | ● | P.U |
|--------------------------|---|----------------------|
| 25 cm | 6 | 202528 25,81€ |



| Couteau à fromage | ● | P.U |
|-------------------|---|----------------------|
| 13 cm | 1 | 200714 15,20€ |



LA DÉCOUPE

Coutellerie



Barre aimantée
Matériaux : PVC /
Acier - ABS

| | | | |
|-------------|---|---------------|---------------|
| 30 x 4,5 cm | 1 | 206028 | 14,13€ |
| 50 x 4,5 cm | 1 | 206029 | 35,96€ |



Scie à main
américaine
Scie de boucher
poignée blanche bâti
inox

| | | | |
|----------------|----|---------------|---------------|
| 45 cm | 1 | 200607 | 47,86€ |
| Lame : 44,5 cm | 10 | 201701 | 3,80€ |



Trousse à couteaux

| | | | |
|-----------|---|---------------|----------------|
| 5 places | 1 | 204513 | 112,77€ |
| 10 places | 1 | 204512 | 187,36€ |



Tablier de protection
Cotte de mailles inox

| | | | |
|------------|---|---------------|----------------|
| 56 x 75 cm | 1 | 200617 | 141,88€ |
|------------|---|---------------|----------------|

AIGUISEUR

Deux barrettes diamant
souples, pour tous
types de lames, acier
ou céramique, lisses ou
crantées.



Aiguiseur
professionnel

| | | | |
|-----|---|---------------|---------------|
| ABS | 1 | 200192 | 76,06€ |
|-----|---|---------------|---------------|

Te position : disque d'aiguisage à gros
grain qui permet de retirer de la matière
lorsque le couteau est émoussé. 2e
position : disque d'affilage à grain fin pour
donner le tranchant.



Aiguiseur
électrique

| | | | |
|-------|----|---------------|----------------|
| 230 V | 10 | 275600 | 104,41€ |
|-------|----|---------------|----------------|



Gants de protection
Cotte de mailles
inox

| | | | |
|------------------|---|---------------|---------------|
| Taille 7 - blanc | 1 | 200618 | 95,10€ |
| Taille 8 - rouge | 1 | 200619 | 95,10€ |
| Taille 9 - bleu | 1 | 200620 | 95,10€ |



Gant anti-coupure

| | | | |
|----------|---|---------------|---------------|
| Taille 7 | 1 | 200844 | 19,03€ |
| Taille 8 | 1 | 200843 | 19,03€ |
| Taille 9 | 1 | 200842 | 19,03€ |



Esse inox

| | | | |
|-------|---|---------------|--------------|
| 12 cm | 1 | 200704 | 1,12€ |
| 16 cm | 1 | 200703 | 1,41€ |
| 20 cm | 1 | 200702 | 3,81€ |



Bobine

| | | | |
|------|---|---------------|---------------|
| 1 kg | 1 | 206699 | 25,15€ |
|------|---|---------------|---------------|



Aiguille à brider
Lot de 5

| | | |
|---|---------------|---------------|
| 1 | 206700 | 21,39€ |
|---|---------------|---------------|



Attendrisseur

| | | | |
|------|---|---------------|---------------|
| 2 kg | 1 | 206701 | 69,01€ |
|------|---|---------------|---------------|



Moule à steak
ovale
Inox

| | | |
|---|---------------|---------------|
| 1 | 200140 | 40,57€ |
|---|---------------|---------------|

Palette de
rechange
Inox

| | | |
|---|---------------|--------------|
| 1 | 204112 | 5,75€ |
|---|---------------|--------------|



Papier paraffiné

| | | | |
|----------|---|---------------|--------------|
| Par 1000 | 1 | 204113 | 6,70€ |
|----------|---|---------------|--------------|

LA DÉCOUPE

Accessoires spéciaux



Éplucheur, étrogneur et tranche à ananas
Corps inox et manche PP

24 cm 1 **205138** **16,76€**



Étrogneur à ananas
Lavable en machine

24 cm 1 **205136** **13,61€**



Raclette à fromage

15 cm 1 **201711** **6,82€**



Canneleur / Zesteur

1 **202342** **7,13€**



Canneleur droitier

1 **202343** **2,96€**



Éminceur à cornichons

1 **280080** **9,76€**



Zesteur

1 **202341** **4,87€**



Couteau à tomate

1 **202355** **5,34€**



Vide-pommes

1 **202348** **5,08€**



Couteau à melon

1 **202351** **6,18€**



Moule à pommes double

∅ 2,2 cm, ∅ 2,8 cm 1 **202347** **11,44€**



Moule à pommes

∅ 2,2 cm 1 **202346** **5,12€**



Couteau à pamplemousse

1 **202354** **5,90€**



Tartineur à sandwich

1 **202356** **6,01€**



Roulette à pâte cannelée

1 **202352** **5,22€**



Coquilleur à beurre

1 **202349** **5,05€**



Fourchette pic Pomme de terre

1 **201710** **2,60€**





LA DÉCOUPE

Accessoires spéciaux

| | | | | |
|-------------------------------------|-------------|---------------|--------------|--|
| | Lame fixe | | | |
| | Lame mobile | | | |
| Éplucheur Inox | | | P.U | |
| 5 cm - lame mobile double tranchant | 31 | 299736 | 1,85€ | |
| 7 cm - lame fixe | 31 | 202358 | 3,34€ | |

| | | | | |
|-------|-----------------------------------|---------------|---------------|------------|
| | Pincès fines de présentation inox | | | P.U |
| 15 cm | 1 | 201703 | 5,06€ | |
| 25 cm | 1 | 201704 | 7,79€ | |
| 30 cm | 1 | 201705 | 12,61€ | |

| | | | | |
|-------|-----------|---------------|---------------|------------|
| | Écailleur | | | P.U |
| 26 cm | 6 | 200609 | 16,14€ | |

ECOPRO

| | | | | |
|-------|---|---------------|--------------|------------|
| | Ciseaux de cuisine Lame acier inoxydable | | | P.U |
| 20 cm | 6 | 205678 | 8,65€ | |

| | | | | |
|--|-------------------------------|---------------|---------------|------------|
| | Sécateur à volaille Chromé | | | P.U |
| | 1 | 205774 | 23,11€ | |

| | | | | |
|-------|--------------------|---------------|--------------|------------|
| | Ciseaux à volaille | | | P.U |
| 24 cm | 1 | 200939 | 8,98€ | |

| | | | | |
|--|--------------------------------------|---------------|--------------|------------|
| | Lancette ouvre huîtres Manche POM | | | P.U |
| | 1 | 202312 | 4,12€ | |

| | | | | |
|--|-------------------|---------------|---------------|------------|
| | Eplucheur tomates | | | P.U |
| | 1 | 206703 | 13,11€ | |

| | | | | |
|--|------------------|---------------|--------------|------------|
| | Rasoir à légumes | | | P.U |
| | 31 | 202359 | 1,80€ | |

| | | | | |
|-------|---|---------------|---------------|------------|
| | Pincès de présentation à bout recourbé inox | | | P.U |
| 15 cm | 1 | 201706 | 5,06€ | |
| 30 cm | 1 | 201708 | 12,61€ | |

| | | | | |
|--|------------------------|---------------|--------------|------------|
| | Pince à arêtes Inox | | | P.U |
| | 1 | 202317 | 4,99€ | |

| | | | | |
|-------|--------------|---------------|--------------|------------|
| | Lyre Inox | | | P.U |
| 21 cm | 1 | 202421 | 8,72€ | |

| | | | | |
|---|-----------------------|---------------|--|------------|
| | Coupe-œuf rondelle | | | P.U |
| 1 | 202987 | 16,28€ | | |
| Pour découper en 10 tranches rondes ou ovales | | | | |

| | | | | |
|---|-----------------------|---------------|--|------------|
| | Coupe œuf quartier | | | P.U |
| 5 | 203077 | 15,96€ | | |

| | | | | |
|------|---------------------------------------|---------------|--------------|------------|
| | Ouvre huîtres à garde lame trempée | | | P.U |
| 6 cm | 6 | 200610 | 2,20€ | |

| | | | | |
|-------------------|-----------------------------|---------------|--------------|------------|
| | Éplucheur coupe julienne | | | P.U |
| Lame trempée 6 cm | 31 | 200700 | 2,20€ | |

| | | | | |
|---------|------------------|---------------|---------------|------------|
| | Rasoir à truffes | | | P.U |
| En inox | 1 | 203637 | 26,10€ | |

| | | | | |
|-------|--|---------------|---------------|------------|
| | Ciseaux à poisson Lame inox crantée | | | P.U |
| 22 cm | 1 | 202209 | 36,61€ | |

| | | | | |
|---------------|-------------|---------------|--------------|------------|
| | Fils à lyre | | | P.U |
| Sachet de 100 | 1 | 202423 | 4,66€ | |

| | | | | |
|---------|--------------------------|---------------|--------------|------------|
| | Ciseaux multi- usages | | | P.U |
| 21,5 cm | 1 | 299343 | 6,79€ | |

| | | | | |
|--|--------------------|---------------|--------------|------------|
| | Lancette à huîtres | | | P.U |
| | 6 | 202316 | 5,21€ | |

| | | | | |
|------|---------------------------------|---------------|--------------|------------|
| | Couteau à huîtres avec garde | | | P.U |
| 6 cm | 6 | 206702 | 3,01€ | |

| | | | | |
|--|------------|---------------|---------------|------------|
| | Coupe-œufs | | | P.U |
| | 1 | 206704 | 29,48€ | |

LA PRÉPARATION

Mandoline



La mandoline, c'est l'accessoire idéal pour couper, émincer et/ ou râper très finement efficacement, rapidement et en toute sécurité tous vos fruits et légumes.

Le choix est large, nos mandolines professionnelles ont été conçues pour un usage intensif. Elles sont généralement en inox dans un souci d'hygiène alimentaire. Elles bénéficient en outre d'un niveau de sécurité optimale (poussoir, porte lame protégé,...) la rendant paradoxalement particulièrement adaptée pour un amateur peu habitué à ce type d'ustensile, et pour le particulier pour une utilisation plus fréquente.



Mini mandoline P.U

Coupe-légumes ultra-compact avec une lame horizontale intégrée et 2 peignes Julienne 2 et 4 mm. Hauteur de coupe de 0 à 5 mm. L 28.5 cm - l 11 cm - H 4 cm

1 **202988** **30,14€**



Mandoline japonaise standard P.U

Grand modèle 95 mm Résistance thermique : 70° C. Épaisseur de coupe réglable de 0,5 à 5 mm. 3 peignes effileurs (1-2-4 mm) et 1 poussoir de sécurité.

1 **205129** **75,17€**



Mandoline En inox P.U

Épaisseur de tranches et gaufrettes réglables. Tranches lisses ou gauffrées, frites et juliennes. Dispose d'un appui bord de tables, 2 blocs effileurs intégrés, lame lisse, lame gauffrée. 3 & 10 mm avec chariot poussoir

1 **204517** **159,49€**



Mandoline access P.U

Mandoline complète avec poussoir. 1 double lame horizontale : lisse et ondulée, 1 double peigne (4-10 mm), réglage facile de la hauteur de coupe, lame horizontale micro lobes, poussoir ergonomique. L 44,5 cm - l 18 cm - H 23 cm

6 **205128** **90,39€**



Mandoline viper P.U

1 poussoir protecteur ergonomique. 1 plateau pour coupe tranches réglable pour une épaisseur de 1 à 8 mm. 2 plateaux lames Julienne : 4 et 10 mm. 1 boîte de rangement. Pieds anti-dérapants repliables

1 **203809** **102,32€**



Mandoline swing P.U

Système de double lame horizontale. Parfaite pour les découpes de fruits ou légumes fermes. Système de double peigne Julienne, 4 et 10 mm. Pour rondelles lisses ou ondulées, gauffrée. Lavage des lames à la main

1 **203262** **67,55€**

Mandoline compact pro basalt P.U

6 **206705** **89,10€**



Rabot et lame P.U

Lame interchangeable 1 **299732** **58,70€**

Rabot pour planche 1 **299733** **58,70€**





LA PRÉPARATION

Manuelle



Râpe 4 faces **P.U**
25 cm 1 **203064** **5,22€**



Râpe inox **P.U**
Extra fine 1 **203688** **11,22€**
Fine 1 **203065** **11,22€**
Épaisse 1 **203689** **10,23€**



Râpe **P.U**
À truffe 1 **201004** **32,61€**



Râpe microplane Premium **P.U**
À zester 1 **200771** **201000** **201001** **201002** **201003** **205132** **21,80€**



Essoreuse manuelle à salade **P.U**
5 L 1 **206697** **79,00€**
10 L 1 **203019** **106,00€**
20 L 1 **203020** **126,00€**



Râpe **P.U**
À muscade 1 **109125** **11,30**



Râpe Premium **P.U**
À épices 1 **205133** **17,84€**



Moulin broyeur **P.U**
Ø31 cm, débit 1 - 1,5 kg/min - Grilles 1,5-2,5-4 mm 1 **201714** **113,84€**



Moulin broyeur **P.U**
Ø 37 cm, débit 1 - 1,5 kg/min - Grilles 3 mm 1 **201713** **289,06€**

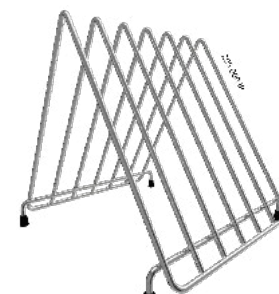

Rack égouttoir Inox **P.U**
Capacité 6 planches 1 **202929** **24,81€**

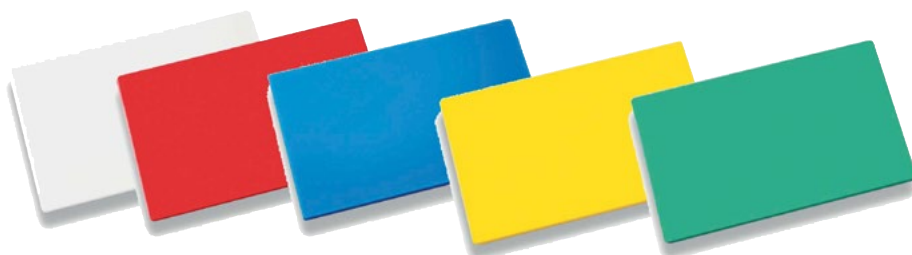

Polypropylène de couleur pour éviter les contaminations croisées. Les deux côtés conviennent pour le découpage. Conforme aux normes HACCP. En polyéthylène 500.

Planche à découper **P.U**
Blanc **P.U** Rouge **P.U** Bleu **P.U** Jaune **P.U** Vert **P.U**

| | | | | | | | | | | | |
|----------------|---|---------------|---------------|---------------|---------------|---------------|---------------|---------------|---------------|---------------|---------------|
| 40 x 30 x 2 cm | 1 | 202536 | 13,34€ | 202537 | 13,34€ | 202538 | 13,34€ | 202539 | 17,25€ | 202540 | 13,34€ |
| 50 x 30 x 2 cm | 1 | 203966 | 16,19€ | 203967 | 16,19€ | 203970 | 16,19€ | 203969 | 16,19€ | 203968 | 15,71€ |
| 60 x 40 x 2 cm | 1 | 202541 | 26,80€ | 202542 | 26,80€ | 202543 | 26,80€ | 202544 | 26,80€ | 202534 | 26,80€ |

LA PRÉPARATION

Manuelle



Rondelles et tranches : rondelles de tomates, agrumes, kiwis, mozzarella en un seul geste



Version haute,
lame inox



x10



| Ouvre-boîte | | P.U |
|----------------------|---|---------------|
| Papillon (Lot de 10) | 1 | 200775 12,72€ |
| Palm | 1 | 203753 18,72€ |
| Titan | 1 | 203075 30,53€ |

Coupe-tomates et mozzarella

5,5 mm. 13 lames en V 1 202049 380,70€



Coupe-tomates inox

| | | |
|--------------|---|----------------|
| 4 quartiers | 1 | 201617 175,39€ |
| 6 quartiers | 1 | 201618 175,39€ |
| 8 quartiers | 1 | 203070 188,38€ |
| 12 quartiers | 1 | 201619 175,39€ |



Coupe-frites sur socle de table

| | | |
|------------------------|---|----------------|
| Sans grille | 1 | 202266 259,66€ |
| Avec grille 8 x 8 mm | 1 | 203071 298,13€ |
| Avec grille 10 x 10 mm | 1 | 202265 298,13€ |

Kit couteau poussoir

| | | |
|------------|---|---------------|
| 6 x 6 mm | 1 | 202267 43,03€ |
| 8 x 8 mm | 1 | 202268 43,61€ |
| 10 x 10 mm | 1 | 202269 43,61€ |
| 10 x 20 mm | 1 | 202271 43,61€ |
| 13 x 13 mm | 1 | 202270 43,61€ |
| 20 x 20 mm | 1 | 202273 43,61€ |
| Potatoes | 1 | 202272 43,03€ |



Presse-boîte manuel InoxInox

28,5 x 40,5 x 112 cm 1 203086 838,39€

Ouvre-boîte manuel tête inox
Convient pour toutes les boîtes jusqu'à la 5/l.

| | | |
|----------------------|---|----------------|
| Fixation serre-joint | 1 | 202191 379,21€ |
| À visser | 1 | 202190 365,97€ |



Ouvre-boîte sécurité sans bord tranchant - Inox

Socle plat à visser 1 205146 509,05€

Ouvre-boîte manuel tête composite
Convient pour toutes les boîtes jusqu'à la 5/l.

| | | |
|----------------------|---|----------------|
| Fixation serre-joint | 1 | 203085 164,92€ |
| À visser | 1 | 203084 142,79€ |



Kit de rechange inox

Lame, bague et outil de démontage avec molette 1 200776 44,68€

Kit de rechange inox Pour ouvre-boîtes manuel 1 205104 44,07€



LA PRÉPARATION

Manuelle



Sectionneur melon inox **P.U**

6 parts - 27 x 20 x 42 cm 1 **205107** 199,92€

8 parts - 27 x 20 x 42 cm 1 **205108** 203,56€

Couteau sectionneur melon inox **P.U**

6 parts 1 **205142** 110,33€

8 parts 1 **205143** 113,61€



Coupe citron inox **P.U**

1 **205135** 211,85€



Coupe agrumes Version basse **P.U**

6 sections - lame inox 1 **201829** 175,39€



Coupe et vide-pommes inox
Coupe en quartiers et retire le trognon des pommes **P.U**

1 **205141** 189,68€



Pèle-pommes à ventouse
Pour éplucher, trancher et étrognier. **P.U**

23 x 10 x 14 cm - Tranches 4 mm 1 **205105** 24,80€



Pèle-pommes à ventouse
Pour peler et étrognier sans trancher. **P.U**

41 x 12 x 18,5 cm 1 **205106** 30,64€



Pèle-pomme
Pèle, étrogne, émince en une seule opération. **P.U**

Fixation serre-joint 1 **203081** 19,35€

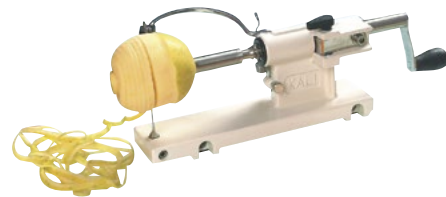

Pèle-pomme professionnel Kali
Pèle, étrogne, émince en une seule opération. Rendement environ 40 kg pommes/h. **P.U**

Fixation serre-joint 1 **203079** 294,36€



Tête assemblée avec poussoir Inox **P.U**

12,5 x 12,5 x 20 cm 1 **203073** 162,60€



Éplucheur à concombres sur pied Inox **P.U**

21,5 x 14 x 51 cm 1 **203074** 241,71€

LA PRÉPARATION

Ustensiles



Des fouets de cuisine professionnels pour battre, touiller, aérer, émulsionner...



Fouet manche composite avec
crochet
Fils inox 18/10



P.U

| Longueur | Quantité | Code produit | Prix unitaire |
|----------|----------|--------------|---------------|
| 25 cm | 1 | 206706 | 9,90€ |
| 30 cm | 1 | 206707 | 10,12€ |
| 35 cm | 1 | 206708 | 10,99€ |
| 40 cm | 1 | 206709 | 11,88€ |
| 45 cm | 1 | 206710 | 13,20€ |



Fouet de cuisine professionnel
Manche inox à crochet. Fils inox 18/10



P.U

| Longueur | Quantité | Code produit | Prix unitaire |
|----------|----------|--------------|---------------|
| 25 cm | 1 | 203632 | 12,69€ |
| 30 cm | 1 | 203633 | 13,16€ |
| 35 cm | 1 | 203634 | 14,15€ |
| 40 cm | 1 | 203635 | 14,53€ |



Fouet spécial collectivité
Fils inox, manche antibactérien



P.U

| Longueur | Quantité | Code produit | Prix unitaire |
|----------|----------|--------------|---------------|
| 60 cm | 1 | 202060 | 68,74€ |

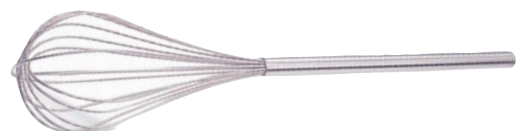

Fouet à purée
Inox, épaisseur des fils 3mm



P.U

| Longueur | Quantité | Code produit | Prix unitaire |
|----------|----------|--------------|---------------|
| 120 cm | 1 | 202100 | 45,23€ |

Fouet à blanc avec crochet
Manche inox. Fils inox 18.8



P.U

| Longueur | Quantité | Code produit | Prix unitaire |
|----------|----------|--------------|---------------|
| 370 cm | 1 | 200237 | 30,28€ |



Fouet à purée forme
boule
Inox, manche
antibactérien



P.U

| Longueur | Quantité | Code produit | Prix unitaire |
|----------|----------|--------------|---------------|
| 80 cm | 1 | 201208 | 165,02€ |
| 100 cm | 1 | 200203 | 167,29€ |
| 120 cm | 1 | 201212 | 170,34€ |





| Louche inox | Q | P.U |
|----------------------|----------|--------|
| Ø 6 cm, à bec - 5 cl | 6 202005 | 7,27€ |
| Ø 6 cm - 5 cl | 6 202006 | 5,59€ |
| Ø 8 cm - 13 cl | 6 202008 | 7,10€ |
| Ø 10 cm - 25 cl | 6 202010 | 9,15€ |
| Ø 12 cm - 45 cl | 6 202012 | 10,75€ |
| Ø 14 cm - 67 cl | 6 202014 | 18,39€ |
| Ø 16 cm - 100 cl | 6 202016 | 21,72€ |
| Ø 20 cm - 200 cl | 6 202020 | 34,89€ |



| Écumoire inox | Q | P.U |
|---------------|----------|--------|
| Ø 8 cm | 6 212208 | 5,65€ |
| Ø 10 cm | 6 202210 | 7,27€ |
| Ø 12 cm | 6 202212 | 8,64€ |
| Ø 14 cm | 6 202214 | 11,03€ |
| Ø 20 cm | 6 202220 | 25,77€ |



| Louche Épaisseur manche 2,8 mm | Q | P.U |
|--------------------------------|----------|--------|
| Ø 6,5 cm - 70 cl | 1 206711 | 5,82€ |
| Ø 8 cm - 12,5 cl | 1 206712 | 6,57€ |
| Ø 9 cm - 20 cl | 1 206713 | 7,59€ |
| Ø 10 cm - 25 cl | 1 206714 | 8,40€ |
| Ø 12 cm - 43 cl | 1 206715 | 9,12€ |
| Ø 14 cm - 65 cl | 1 206716 | 10,95€ |
| Ø 16 cm - 95 cl | 1 206717 | 12,78€ |



| Écumoire Épaisseur manche 2,8 mm | Q | P.U |
|----------------------------------|----------|--------|
| Ø 8 cm | 1 206719 | 4,56€ |
| Ø 10 cm | 1 206720 | 5,91€ |
| Ø 12 cm | 1 206721 | 7,74€ |
| Ø 14 cm | 1 206722 | 8,78€ |
| Ø 16 cm | 1 206723 | 10,47€ |
| Ø 18 cm | 1 206724 | 13,50€ |
| Ø 20 cm | 1 206725 | 16,04€ |



| Écumoire araignée multi-fonctions Maille inox. L manche : 41 cm. | Q | P.U |
|--|----------|--------|
| Ø 12 cm | 1 206718 | 36,24€ |



| Louche inox Manche antibactérien | Q | P.U |
|----------------------------------|----------|---------|
| Ø 18 cm, L 50 cm, 150 cl | 1 202350 | 105,93€ |
| Ø 20 cm, L 80 cm, 250 cl | 1 202380 | 134,82€ |



| Écumoire inox Manche antibactérien | Q | P.U |
|------------------------------------|----------|--------|
| Ø 18 cm, 50 cm | 1 202118 | 89,50€ |
| Ø 20 cm, 80 cm | 1 202120 | 97,89€ |

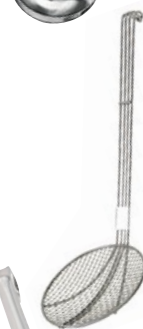

| Araignée à friture En acier inoxydable | Q | P.U |
|--|----------|--------|
| Ø 12 cm | 1 201142 | 12,85€ |
| Ø 14 cm | 1 201143 | 14,45€ |
| Ø 16 cm | 1 201144 | 17,35€ |
| Ø 18 cm | 1 201146 | 20,69€ |
| Ø 20 cm | 1 201147 | 23,03€ |
| Ø 22 cm | 1 201148 | 25,07€ |



| Araignée carrée inox Manche antibactérien | Q | P.U |
|---|----------|---------|
| 22 x 22 cm | 1 203916 | 115,55€ |
| 26 x 26 cm | 1 203915 | 123,69€ |
| 30 x 30 cm | 1 203914 | 144,39€ |



| Cuillère à arroser inox Pour récupérer le jus de cuisson des viandes, poissons et les arroser en cours de cuisson. | Q | P.U |
|--|----------|-------|
| 35 cm - bec de côté | 6 202202 | 7,91€ |
| 37 cm - bec droit | 6 202201 | 7,91€ |



| Vide marmite Inox | Q | P.U |
|----------------------|----------|--------|
| Pochon 2 L - Ø 20 cm | 1 205736 | 45,42€ |

LA PRÉPARATION

Ustensiles

SOMMAIRE | INDEX

32
DUMAS® **pujadas**
A VOLLRATH® COMPANY

SAINT ROMAIN
FABRICANT

de Buyer
GARCIADEPOU



Pelle à frites inox
2 poignées

20 x 5 x 22,5 cm 1 **202882** **12,60€**



Pelle de cuisson
ajourée
Manche
antibactérien

50 cm 1 **202150** **77,22€**



Pelle Spécial
collectivités

Pleine, L 25 x 50 cm 1 **201696** **93,33€**

Ajourée, L 25 x 50 cm 1 **201697** **104,30€**



Spatule triangulaire
Inox, manche
composite

10 cm 1 **281010** **3,72€**



Spatule monobloc
coudée
Inox

Pleine, L 10 x 44 cm 6 **202205** **10,68€**

Perforée, L 10 x 44 cm 6 **202203** **10,42€**



Pelle à omelette
inox

L 30 x l 28 cm 6 **203636** **19,34€**

Spatule droite
flexible
Inox, Manche ABS

15 cm 25 **202315** **4,86€**

21 cm 25 **206726** **5,08€**

25 cm 25 **206727** **5,68€**

30 cm 25 **202330** **6,93€**

35 cm 25 **212335** **5,18€**

40 cm 25 **212340** **7,76€**



Spatule étroite
coudée flexible
Inox

24 cm 6 **202324** **7,00€**

29 cm 6 **202329** **8,21€**





LA PRÉPARATION

Ustensiles



Spatule souple ajourée Nylon **P.U**
L 28 x l 6,5 cm 6 **200001** **3,08€**



Spatule de cuisson Haute température 250 °C. Matière composite. **P.U**
37 cm 25 **202207** **6,36€**



Spatule Composite. Résiste jusqu'à 220 °C. **P.U**

| | | | |
|-------|----|---------------|--------------|
| 25 cm | 25 | 202225 | 2,05€ |
| 30 cm | 25 | 202230 | 2,62€ |
| 35 cm | 25 | 202235 | 2,89€ |
| 40 cm | 25 | 202240 | 4,01€ |
| 45 cm | 25 | 206728 | 5,23€ |
| 50 cm | 25 | 202250 | 6,20€ |

MARYSE

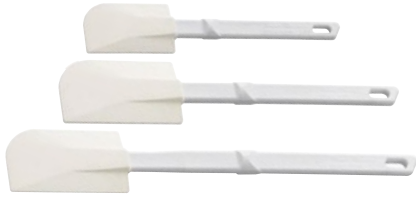

Spatule pâtissière souple Manche composite **P.U**

| | | | |
|-------|----|---------------|--------------|
| 25 cm | 25 | 203638 | 3,30€ |
| 35 cm | 25 | 203639 | 4,72€ |
| 45 cm | 25 | 203640 | 4,94€ |



Fourchette à viande Spécial collectivités, inox. **P.U**
35 cm 1 **202335** **37,69€**



Spatule inox **P.U**

| | | | |
|--------|---|---------------|---------------|
| 90 cm | 1 | 240090 | 26,91€ |
| 120 cm | 1 | 240120 | 32,71€ |

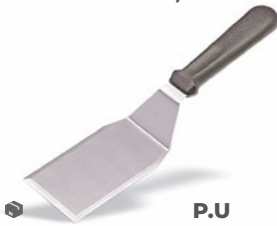

Spatule large coudée **P.U**
70 x 300 1 **202301** **4,76€**



Spatule large coudée **P.U**

| | | | |
|---------------------|---|---------------|--------------|
| 75 x 215 | 1 | 202309 | 3,83€ |
| 75 x 215 - perforée | 1 | 202302 | 3,75€ |



Pelle ajourée **P.U**
17 cm 1 **202303** **6,73€**

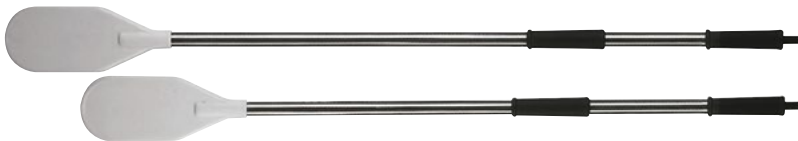

Pelle spatule renforcée Polyamide, manche inox antibactérien **P.U**

| | | | |
|--------|---|---------------|----------------|
| 100 cm | 1 | 200100 | 109,17€ |
| 120 cm | 1 | 200121 | 114,18€ |



Spatule haute température Résistante à 260°. Épaisseur 3,5. **P.U**

| | | | |
|---------|---|---------------|--------------|
| 34 cm | 1 | 206729 | 6,88€ |
| 35,5 cm | 1 | 206730 | 8,84€ |
| 42 cm | 1 | 206731 | 8,97€ |



Support inox Pour spatule et fouet. **P.U**
40 cm 1 **202339** **26,89€**

Matériau composite Exoglass® Spécialement conçue pour l'utilisation dans les récipients antiadhésifs.

Spatule ajourée **P.U**

| | | | | | | |
|-------|---|---------------|---------------|---------------|---------------|--------------|
| 30 cm | 1 | 206030 | 206031 | 206032 | 206033 | 6,80€ |
| | | Noir | Bleu | Rouge | Gris | |



LA PRÉPARATION

Ustensiles



Idéal pour les mousses. Buse intégrée Ø 15 mm, supporte les préparations très chaudes. Cône profond pour une poussée sans pression.



Passe-sauce conique  **P.U**
20 cm 1 **206732** **77,94€**



Support passe-sauce  **P.U**
21 cm 1 **206733** **25,59€**



Entonnoir à confiture inox  **P.U**
Ø 13,5 cm - 500 ml 1 **206734** **12,33€**



Chinois étamine  **P.U**
Ø 20 cm 1 **204519** **60,07€**



Passoire conique Avec queue et crochet  **P.U**
Ø 24 cm 1 **223224** **51,11€**
Ø 28 cm 1 **223228** **58,39€**



Entonnoir inox Avec filtre mobile  **P.U**
Ø 15 cm 1 **249016** **14,09€**
Ø 20 cm 1 **249020** **15,09€**



Passoire extensible pour l'évier  **P.U**
34 x 24 cm 1 **205737** **17,22€**



Passoire cerclée acier inoxydable  **P.U**
Ø 30 cm 1 **212632** **60,27€**
Ø 35 cm 1 **202636** **70,28€**
Ø 40 cm 1 **202640** **79,35€**
Ø 45 cm 1 **202644** **93,87€**
Ø 50 cm 1 **205111** **120,62€**



Passe-bouillon inox  **P.U**
Ø 10 cm 1 **202989** **5,36€**
Ø 12 cm 1 **202990** **6,88€**
Ø 14 cm 1 **202991** **7,96€**
Ø 16 cm 1 **202992** **9,45€**
Ø 18 cm 1 **202993** **10,74€**



Chinois  **P.U**
Ø 18 cm 1 **202618** **11,14€**
Ø 20 cm 1 **212620** **11,54€**
Ø 24 cm 1 **212624** **14,43€**
Ø 26 cm 1 **212626** **15,00€**

Idéal pour les mousses. Buse intégrée Ø 15 mm, supporte les préparations très chaudes. Cône profond pour une poussée sans pression.



Entonnoir à piston inox
330 cl, avec support 1 **200699 119,84€**



Entonnoir à piston inox
190 cl, avec support 1 **202311 112,51€**



Mini entonnoir à piston inox
80 cl, avec support 1 **299352 35,17€**



Distributeur à pression
Double 20 cl 1 **201816 1,75€**
Triple 50 cl 1 **201817 4,56€**



Machines à pâtes manuelle
34 x 20,5 x 29 cm 1 **206735 89,10€**



Accessoire pour machine à pâtes
Ravioli - 17,8 x 11,5 x 9,2 cm 6 **206736 65,09€**
Spaghetti - 17 x 7 x 4,5 cm 6 **206737 37,15€**



Flacon verseur
35 cl 16 **202332 2,47€**
75 cl 16 **202336 3,36€**

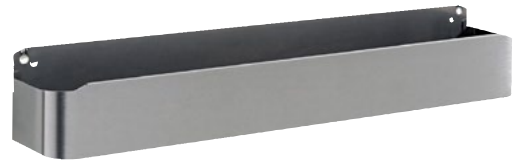

Etagère murale pour bouteilles
65 cm 1 **206738 68,74€**

Organisateurs pour flacon verseur GN1/2
32,5 x 26,5 - H 10 cm 3 x Ø 7,5 cm 8 x Ø 6 cm Pour flacon 75 cl 6 **202926 27,43€**
32,5 x 17,6 - H 10 cm - 6 x Ø 6 cm Pour flacon 35 cl 6 **202927 20,17€**
32,5 x 17,6 - H 10 cm - 3 x Ø 7,5 cm Pour flacon 75 cl 6 **202928 21,39€**

LA PRÉPARATION de pâtisserie

SOMMAIRE | INDEX



FISCHER
OUTILLAGE DE PÂTISSIER

de Buyer
DE PÂTISSIER

BOURGEAT



| Corne souple à pâtisserie | | Blanc | Jaune | |
|---------------------------|--------|-------|--------|-------|
| | | P.U | P.U | P.U |
| 1 | 202921 | 1,15€ | 202922 | 3,47€ |



| Corne à ramasser Nylon | | | P.U |
|------------------------|---|--------|-------|
| Ø 14,7 x 10 cm | 1 | 202655 | 1,07€ |
| Ø 20 x 15 cm | 1 | 202015 | 2,36€ |
| Ø 21,5 x 12,5 cm | 1 | 202112 | 2,54€ |



| Diviseur à pâte | | | P.U |
|-----------------|---|--------|--------|
| 5 roulettes | 1 | 202249 | 23,91€ |
| 6 roulettes | 1 | 202634 | 25,96€ |
| 7 roulettes | 1 | 202248 | 29,79€ |



| Coupe-pâte | | | P.U |
|------------|----|--------|-------|
| Carré | 10 | 202637 | 2,94€ |
| Arrondi | 10 | 202652 | 2,97€ |



| Rouleau à pâte pic-vite | | | P.U |
|-------------------------|---|--------|-------|
| Largeur 10 cm | 1 | 202651 | 8,12€ |



| Rouleau pic vite, inox | | | P.U |
|------------------------|---|--------|--------|
| Largeur 10 cm | 1 | 202635 | 10,39€ |



| Bassine demi-sphérique Polypropylène | | | P.U |
|--------------------------------------|---|--------|--------|
| Ø 23 cm, 250 cl, H 10,5 cm | 1 | 201818 | 4,10€ |
| Ø 28 cm, 450 cl, H 12 cm | 1 | 201819 | 4,59€ |
| Ø 32 cm, 600 cl, H 14,5 cm | 1 | 201820 | 6,65€ |
| Ø 36 cm, 900 cl, H 16 cm | 1 | 201821 | 7,34€ |
| Ø 40 cm, 1300 cl, H 18 cm | 1 | 201822 | 10,74€ |



| Bassine cul de poule | | | P.U |
|-----------------------------|---|--------|--------|
| Ø 20 cm, 200 cl, H 10 cm | 6 | 213020 | 19,34€ |
| Ø 25 cm, 350 cl, H 12,5 cm | 6 | 213025 | 25,42€ |
| Ø 30 cm, 650 cl, H 15 cm | 6 | 213030 | 32,18€ |
| Ø 35 cm, 1000 cl, H 17,5 cm | 6 | 213035 | 43,76€ |
| Ø 40 cm, 1500 cl, H 20 cm | 6 | 213040 | 57,48€ |



| Bassine pâtissière inox | | | P.U |
|----------------------------|---|--------|--------|
| Ø 16 cm, 65 cl, H 5,5 cm | 1 | 202616 | 4,73€ |
| Ø 20 cm, 130 cl, H 7,5 cm | 1 | 202620 | 5,95€ |
| Ø 24 cm, 210 cl, H 8,5 cm | 1 | 202624 | 8,29€ |
| Ø 28 cm, 370 cl, H 11 cm | 1 | 202628 | 12,06€ |
| Ø 32 cm, 600 cl, H 12,5 cm | 1 | 202632 | 14,07€ |



Pinceau manche composite **P.U**

Largeur 4 cm 1 **202740** 5,48€



Pinceau silicone **P.U**

L 19,5 cm 1 **202994** 4,54€



Pinceau soie manche hêtre **P.U**

L 2 cm - Tirure 5 cm 1 **212720** 1,54€

L 3 cm - Tirure 5 cm 1 **212730** 1,70€

L 4 cm - Tirure 5 cm 1 **212740** 2,11€



Rouleau polyamide **P.U**

50 cm 1 **202650** 29,25€



Rouleau de 100 poches pâtisseries jetables **P.U**

40 cm 1 **202608** 16,27€

45 cm 1 **202609** 18,08€



Poche à décorer jetables **P.U**

40 cm 1 **202626** 15,47€

55 cm 1 **299779** 23,21€



1 poche pâtissière et 2 douilles En polyuréthane **P.U**

35 cm 1 **206740** 15,53€



Support pour poches à dresser En polypropylène **P.U**

Ø 19,5 cm 1 **200716** 13,70€

LA PRÉPARATION

de pâtisserie



Douilles assorties
Inox **P.U**

| | | | |
|----------|---|---------------|---------------|
| Lot de 6 | 1 | 206739 | 12,05€ |
|----------|---|---------------|---------------|



Boîte de 24 douilles
Acrylique **P.U**

| | | |
|---|---------------|---------------|
| 1 | 200558 | 10,83€ |
|---|---------------|---------------|



Poche pâtissière
nylon **P.U**

| | | | |
|-------|---|---------------|--------------|
| 35 cm | 1 | 280035 | 3,91€ |
| 40 cm | 1 | 280040 | 4,37€ |
| 45 cm | 1 | 280045 | 5,15€ |
| 50 cm | 1 | 280050 | 5,81€ |
| 60 cm | 1 | 280060 | 7,04€ |



Boîte de 9
découpoirs
Inox **P.U**

| | | | |
|----------|---|---------------|---------------|
| Cannelés | 1 | 258810 | 20,33€ |
| Unis | 1 | 258805 | 16,78€ |



Pince à pâte
Inox **P.U**

| | | |
|---|---------------|--------------|
| 1 | 202653 | 3,50€ |
|---|---------------|--------------|



Boîte de 6 douilles
Inox, cannelées **P.U**

| | | | |
|-----------------|---|---------------|---------------|
| Inox, cannelées | 1 | 203641 | 13,42€ |
| Inox, unies | 1 | 203642 | 13,42€ |

Unis



Cannelés



Boîte découpoirs **P.U**

| | | | |
|----------|---|---------------|---------------|
| Unis | 1 | 203923 | 23,37€ |
| Cannelés | 1 | 203924 | 23,37€ |



Découpoir poire **P.U**

| | | |
|---|---------------|---------------|
| 1 | 206741 | 47,72€ |
|---|---------------|---------------|



Découpoir
pomme **P.U**

| | | |
|---|---------------|---------------|
| 1 | 206742 | 47,72€ |
|---|---------------|---------------|

MOULES ANTI-ADHÉRENTS À REVÊTEMENT BI-COUCHE

Le système bi-couche assure un démoulage parfait et permet de charger la couche supérieure en mica et de la rendre moins fragile. Longévité du revêtement. Très bonne résistance à l'abrasion.



| Caisse à génoise droite | P.U |
|-------------------------|-----------------|
| 40 x 30 cm, H 3,5 cm | 1 290140 25,88€ |
| 51 x 36 cm, H 5 cm | 1 290151 35,11€ |



| Moule à savarin | P.U |
|-------------------|-----------------|
| Ø 8 cm, H 2,0 cm | 1 224030 2,59€ |
| Ø 12 cm, H 2,5 cm | 1 224034 4,92€ |
| Ø 24 cm, H 5,8 cm | 1 290724 12,26€ |
| Ø 26 cm, H 6,2 cm | 1 290726 13,72€ |



| Moule à manqué rond | P.U |
|---------------------|-----------------|
| Ø 20 cm, H 4,5 cm | 1 290520 7,60€ |
| Ø 24 cm, H 5 cm | 1 290524 9,44€ |
| Ø 26 cm - H 5 cm | 1 202051 9,14€ |
| Ø 28 cm, H 5 cm | 1 290528 11,60€ |
| Ø 32 cm, H 5,5 cm | 1 290532 15,19€ |

MOULES ANTI-ADHÉRENTS À REVÊTEMENT BI-COUCHE

Fond démontable, à charnières



| Moule | À pâté en croûte | À cake | P.U |
|-----------------------|------------------|--------|--------|
| 30 x 4 cm, H 6 cm | 1 202710 | - | 27,75€ |
| 26 x 9,5 cm, H 7,5 cm | 1 - | 290626 | 10,65€ |
| 28 x 10 cm, H 7,5 cm | 1 - | 290628 | 11,02€ |
| 30 x 8 cm, H 8 cm | 1 290630 | - | 29,49€ |
| 40 x 8 cm, H 8 cm | 1 290640 | - | 32,20€ |



| Moule à manqué carré fond fixe | P.U |
|--------------------------------|-----------------|
| 22 x 22 cm, H 5 cm | 1 224110 13,76€ |
| 24 x 24 cm, H 5 cm | 1 224120 14,67€ |



| Noyaux de cuisson | P.U |
|-------------------|-----------------|
| Céramique 1 kg | 1 202923 16,04€ |
| Aluminium 1 kg | 1 206743 28,59€ |



| Moule à pain de mie Avec couvercle, Bords cannelés fond mobile | P.U |
|---|-----------------|
| 25 x 9,3 cm H 7,6 cm | 1 299900 22,22€ |

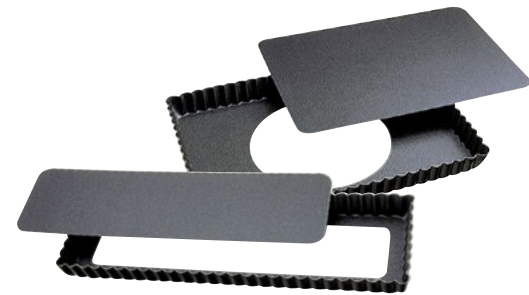

| Tarte maison rectangulaire Bords cannelés fond mobile | P.U |
|---|-----------------|
| 29 x 20,5 cm, H 2,5 cm | 1 200222 13,77€ |
| 35 x 11 cm, H 2,5 cm | 1 200221 9,73€ |



| Spray de démoulage | P.U |
|--------------------|----------------|
| | 1 202924 7,86€ |



| Plaque perforée 2 baguettes Antiadhérent Obsidien | P.U |
|---|-----------------|
| 38 x 16 cm | 1 205783 13,76€ |



| Dariole antiadhésive | P.U |
|----------------------|----------------|
| Ø 6 x H 6 cm | 1 290006 3,28€ |

LA PRÉPARATION de pâtisserie

SOMMAIRE | INDEX

de Buyer
DEPUIS 1830

LOUIS TELLIER

BOURGEAT

MOULES ANTI-ADHÉRENTS À REVÊTEMENT BI-COUCHE



| Tourtière | Fond mobile | P.U | Fond fixe | P.U | | |
|-------------------|-------------|--------|-----------|-----|--------|-------|
| Ø 24 cm, H 2,5 cm | 1 | 290324 | 9,42€ | 1 | 290424 | 5,98€ |
| Ø 28 cm, H 2,5 cm | 1 | 290328 | 12,27€ | 1 | 290428 | 7,44€ |
| Ø 32 cm, H 2,5 cm | 1 | 290332 | 15,27€ | 1 | 290432 | 8,91€ |

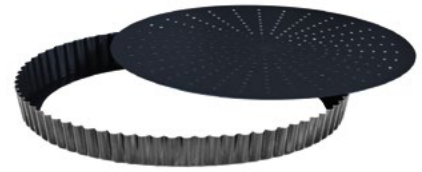

| Tourtière cannelée perforée | Fond mobile | P.U |
|-----------------------------|-------------|---------------|
| Ø 24 cm, H 2,8 cm | 1 | 205785 12,12€ |
| Ø 28 cm, H 2,8 cm | 1 | 205784 16,26€ |
| Ø 32 cm, H 2,8 cm | 1 | 205786 19,10€ |



| Tartelette ronde | P.U |
|-------------------|----------------|
| Ø 8 cm, H 1,2 cm | 1 290008 1,26€ |
| Ø 10 cm, H 1,8 cm | 1 290010 1,54€ |
| Ø 12 cm, H 2 cm | 1 290012 1,96€ |



| Moule à brioche antiadhésif | P.U |
|-----------------------------|----------------|
| Ø 14 cm, H 4,8 cm | 1 223010 3,49€ |
| Ø 16 cm, H 5,5 cm | 1 223020 4,31€ |
| Ø 18 cm, H 5,6 cm | 1 223030 4,98€ |
| Ø 20 cm, H 7,2 cm | 1 223040 6,78€ |
| Ø 22 cm, H 8,7 cm | 1 223050 9,01€ |



| Plaques madeleines | P.U |
|---------------------------------------|-----------------|
| 20 minis madeleinettes 39,5 x 12,5 cm | 1 264510 8,63€ |
| 12 madeleines 39,5 x 20 cm | 1 264710 10,87€ |



| Moule à charlotte | P.U |
|-------------------|-----------------|
| Ø 18 cm, H 10 cm | 1 212621 14,60€ |



| Pelle de service | P.U |
|------------------|----------------|
| 29 cm | 1 205738 9,67€ |

ELASTOMOULE

Adapté pour la cuisson simultanée de petits gateaux individuels. Mousse de silicone haute qualité avec poudre de métal : supporte les températures allant de -70°C à +300°C. Excellente conductibilité de la chaleur et du froid. Cuisson homogène et caramélisation des sucs. Surface intérieure lisse : anti-adhérence naturelle et démoulage facilité.



| 9 cakes | P.U |
|--------------|-----------------|
| 30 x 17,6 cm | 1 202426 30,08€ |



| 25 financiers | P.U |
|---------------|-----------------|
| 30 x 17,6 cm | 1 202427 30,08€ |



| 24 mini tartelettes | P.U |
|-----------------------|-----------------|
| Ø 4,5 cm - 30 x 20 cm | 1 202429 30,08€ |

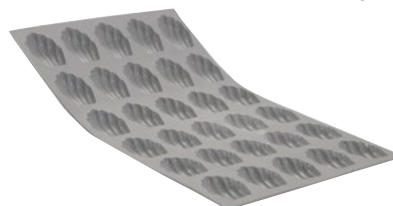

| 30 mini madeleines | P.U |
|--------------------|-----------------|
| 30 x 17,6 cm | 1 202428 30,08€ |



LA PRÉPARATION de pâtisserie

MULTI OPERA



Cadre à opéra professionnel P.U.

| | | | |
|--|---|--------|--------|
| 32 x 32 cm - H 4,5 cm - 1-25 parts | 1 | 204571 | 42,80€ |
| 32 x 38 cm - H 4,5 cm - 1-30 parts | 1 | 204570 | 50,04€ |
| GN1/1 - 50 x 32 cm - H 4,5 cm - 1-40 parts | 1 | 204569 | 59,91€ |
| 58 x 38 cm - H 4,5 cm - 1-54 parts | 1 | 204568 | 75,12€ |



Cadre pâtissier P.U.

| | | | |
|---------------------------|---|--------|--------|
| 36 x 26 cm - H 4,5 cm | 1 | 203502 | 18,73€ |
| 56,5 x 36,5 cm - H 4,5 cm | 1 | 203501 | 26,36€ |



Cadres superposables Plaque avec 3 cadres P.U.

| | | | |
|-----------|---|--------|---------|
| 400 x 300 | 1 | 206744 | 225,79€ |
| 600 x 400 | 1 | 206745 | 268,19€ |



Cadre à entremets P.U.

| | | | |
|--|---|--------|--------|
| Extensible jusqu'à 40 x 21 cm - H 7,5 cm | 1 | 200627 | 27,06€ |
| Extensible jusqu'à 30 x 30 cm - H 5 cm | 1 | 200628 | 21,04€ |
| Extensible jusqu'à 57 x 57 cm - H 5 cm | 1 | 282483 | 35,49€ |



Gouttière à bûche carrée démontable inox P.U.

| | | | |
|---------------|---|--------|--------|
| 30 x 4 x 4 cm | 1 | 202559 | 15,01€ |
|---------------|---|--------|--------|



Gouttière à bûche ronde inox P.U.

| | | | |
|----------------------|---|--------|--------|
| Ø 8 cm - 30 x 6,5 cm | 1 | 200626 | 17,41€ |
| 30 x 4 x 3,6 cm | 1 | 202557 | 15,62€ |



Nonnette rectangle inox P.U.

| | | | |
|---------------|---|--------|-------|
| 6 x 3 x 3 cm | 1 | 299755 | 2,70€ |
| 8 x 4 x 3 cm | 1 | 299756 | 3,02€ |
| 12 x 3 x 3 cm | 1 | 299754 | 3,27€ |



Gouttière à bûche rectangulaire démontable inox P.U.

| | | | |
|-----------------|---|--------|--------|
| 30 x 8 x 6,5 cm | 1 | 202558 | 18,08€ |
|-----------------|---|--------|--------|



Moule à bûches inox P.U.

| | | | |
|---------------------------|---|--------|--------|
| 30 x 8,5 x 6,8 cm - 1,5 L | 1 | 201229 | 22,17€ |
| 50 x 8,5 x 6,8 cm - 2,5 L | 1 | 201230 | 35,55€ |



Ruban pâtissier en pvc P.U.

| | | | |
|-------------------|---|--------|--------|
| L 200 M - H 40 cm | 1 | 282484 | 41,57€ |
| L 200 M - H 45 cm | 1 | 282485 | 45,75€ |
| L 200 M - H 60 cm | 1 | 282487 | 48,76€ |



Moule à canelés P.U.

| | | | |
|----------|---|--------|--------|
| Ø 3,5 cm | 1 | 200631 | 10,18€ |
| Ø 4,5 cm | 1 | 200629 | 11,21€ |



Mesure graduée Inox P.U.

| | | | |
|--------|---|--------|--------|
| 100 cl | 1 | 256510 | 13,29€ |
| 200 cl | 1 | 256520 | 25,44€ |

LA PRÉPARATION

de pâtisserie

SOMMAIRE | INDEX

de Buyer
DEPUIS 1828

LT
LOUIS TELLIER
DEPUIS 1888

pujadas
A VOLLRATH COMPANY



Cercle à tarte perforé P.U

| | | | |
|--------------------|---|---------------|---------------|
| Ø 10,5 cm - H 2 cm | 1 | 202767 | 6,08€ |
| Ø 12,5 cm - H 2 cm | 1 | 202768 | 6,32€ |
| Ø 15,5 cm - H 2 cm | 1 | 202769 | 7,28€ |
| Ø 18,5 cm - H 2 cm | 1 | 202770 | 7,55€ |
| Ø 20,5 cm - H 2 cm | 1 | 202771 | 8,08€ |
| Ø 24,5 cm - H 2 cm | 1 | 202772 | 8,93€ |
| Ø 28,5 cm - H 2 cm | 1 | 202773 | 10,01€ |



Cercle à tarte inox P.U

| | | | |
|------------------|---|---------------|--------------|
| Ø 10 cm - H 2 cm | 1 | 290210 | 2,23€ |
| Ø 12 cm - H 2 cm | 1 | 290212 | 2,33€ |
| Ø 16 cm - H 2 cm | 1 | 290216 | 2,64€ |
| Ø 20 cm - H 2 cm | 1 | 290220 | 3,01€ |
| Ø 24 cm - H 2 cm | 1 | 290224 | 3,41€ |
| Ø 28 cm - H 2 cm | 1 | 290228 | 3,83€ |
| Ø 32 cm - H 2 cm | 1 | 290232 | 4,65€ |

Cercle à tarte perforé inox P.U

| | | | |
|---------------------|---|---------------|---------------|
| Ø 7,5 cm - H 4,5 cm | 1 | 206746 | 9,07€ |
| Ø 20 cm - H 4,5 cm | 1 | 206747 | 12,81€ |
| Ø 24 cm - H 4,5 cm | 1 | 206748 | 13,98€ |



Cercle à mousse inox P.U

| | | | |
|--------------------|---|---------------|--------------|
| Ø 5 cm - H 4 cm | 1 | 298905 | 2,48€ |
| Ø 7,5 cm - H 4 cm | 1 | 298907 | 2,54€ |
| Ø 8 cm - H 4,5 cm | 1 | 298908 | 3,47€ |
| Ø 10 cm - H 4,5 cm | 1 | 298910 | 3,54€ |
| Ø 12 cm - H 4,5 cm | 1 | 298912 | 3,91€ |
| Ø 16 cm - H 4,5 cm | 1 | 298916 | 4,57€ |
| Ø 20 cm - H 4,5 cm | 1 | 298920 | 6,63€ |
| Ø 24 cm - H 4,5 cm | 1 | 298924 | 6,89€ |
| Ø 26 cm - H 4,5 cm | 1 | 298926 | 7,62€ |
| Ø 28 cm - H 4,5 cm | 1 | 298928 | 8,07€ |



Cercle à vacherin inox P.U

| | | | |
|------------------|---|---------------|--------------|
| Ø 16 cm - H 6 cm | 1 | 294016 | 5,95€ |
| Ø 20 cm - H 6 cm | 1 | 294020 | 8,09€ |
| Ø 24 cm - H 6 cm | 1 | 294024 | 9,35€ |



LA PRÉPARATION de pizza



| | | |
|--|---|---------------------|
| Saupoudreuse inox Couvercle transparent | | P.U |
| Ø 1,5 mm, trous fins | 1 | 256521 4,21€ |
| Ø 2 mm, trous moyens | 1 | 256519 4,28€ |
| Ø 4 mm, trous gros | 1 | 256522 4,32€ |



| | | |
|---|---|-----------------------|
| Siphon "Gourmet Whip" Tout en acier inoxydable | | P.U |
| 50 cl | 1 | 200556 96,94€ |
| 100 cl | 1 | 200559 104,31€ |
| Boîte de 10 capsules | 1 | 201323 7,10€ |



| | | |
|------------------------------|---|----------------------|
| Chalumeau compact | | P.U |
| Capacité gaz 21 ml - H 13 cm | 1 | 203919 14,40€ |
| Capacité gaz 40 ml - H 16 cm | 1 | 203918 33,59€ |



| | | |
|----------------------|----|----------------------|
| Chalumeau Matfer | | P.U |
| 24,5 x 11 x H 17 cm | 1 | 201118 37,05€ |
| Cartouche gaz 360 ml | 36 | 201119 3,23€ |



| | | |
|------------------------------|----|----------------------|
| Siphon professionnel Inox | | P.U |
| 0,5 L | 1 | 206750 76,55€ |
| 1 L | 36 | 206749 89,67€ |
| Cartouches de gaz | | P.U |
| Lot de 10 | 1 | 206751 4,97€ |
| Lot de 50 | 36 | 206752 22,95€ |



| | | |
|--|----|----------------------|
| Tamis inox | | P.U |
| 4 mailles interchangeables : (Ø 3mm/2mm/1mm/0,5mm) | 1 | 206753 25,24€ |
| Tamis Ø 30 cm | 36 | 206754 23,20€ |



| | | |
|-----------------------|----|---------------------|
| Cuillère à glace | | P.U |
| 74 ml - 4,5 x 17,7 cm | 1 | 100864 4,69€ |
| 60 ml - 4,2 x 17,7 cm | 36 | 100865 4,69€ |
| 44 ml - 3,8 x 17,7 cm | 36 | 100866 4,69€ |



LA PRÉPARATION

Divers



Ciseaux coudés à pizza Ergonomique

24,5 cm 1 206755 27,61€

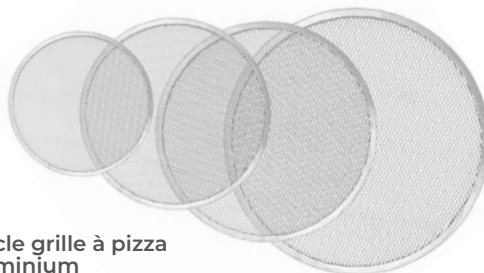

Cercle grille à pizza Aluminium

Ø 28,2 cm 1 299805 3,35€
Ø 30 cm 1 299806 3,64€
Ø 33 cm 1 299807 4,10€
Ø 40,6 cm 1 299808 5,06€



Pelle ronde Hêtre

Ø 35 cm, 300 cm 1 203925 61,56€



Pelle à pizza

Ø 31 cm, L 96 cm 1 203643 46,51€



Pelle à pizza Ronde en alu manche en bois

Ø 40 cm, L 162 cm 1 201698 35,43€



Pelle à pizza Aluminium

31 x 35 cm, L 90 cm 1 201127 26,76€



Roulette à pizza

Ø 10 cm 1 202357 3,72€



Louchette à pizza Inox

5 213608 18,37€



Brosse hollandaise à farine Soies naturelles, manche bois

32 cm 1 203927 15,01€



Brosse demi-tête Soies naturelles, manche bois

35 cm 1 203928 19,25€



Plaque ronde à pizza

Ø 24 cm 5 235024 6,08€
Ø 28 cm 5 235028 7,52€
Ø 32 cm 5 235032 9,15€
Ø 36 cm 5 235036 10,69€
Ø 40 cm 5 235040 13,63€



LA PRÉPARATION

Divers



| Plaque bords pincés Tôle acier | | | | P.U |
|--------------------------------|---|--------|--------|-----|
| GN1/1 - 32,5 x 53 cm | 5 | 232153 | 11,69€ | |
| GN2/1 - 65 x 53 cm | 5 | 201390 | 25,80€ | |
| 40 x 30 cm | 5 | 201391 | 11,73€ | |
| 60 x 40 cm | 5 | 236360 | 13,19€ | |



| Plaque bords pincés Aluminium antiadhésif | | | | P.U |
|---|---|--------|--------|-----|
| GN1/1 - 32,5 x 53 cm | 1 | 216153 | 14,11€ | |
| GN2/1 - 65 x 53 cm | 5 | 201386 | 34,52€ | |
| 40 x 30 cm | 5 | 201387 | 16,94€ | |
| 60 x 40 cm | 1 | 216160 | 18,06€ | |



| Plaque perforée Aluminium | | | | P.U |
|---------------------------|---|--------|--------|-----|
| GN1/1 - 32,5 x 53 cm | 1 | 229803 | 23,31€ | |
| 60 x 40 cm | 5 | 229801 | 26,71€ | |



| Plaque bords pincés Inox | | | | P.U |
|--------------------------|---|--------|--------|-----|
| GN1/1 - 32,5 x 53 cm | 1 | 202774 | 24,20€ | |
| GN2/1 - 65 x 53 cm | 5 | 201388 | 43,38€ | |
| 40 x 30 cm | 5 | 201389 | 17,45€ | |
| 60 x 40 cm | 5 | 236160 | 25,60€ | |



| Plaque bords droits Inox | | | | P.U |
|--------------------------|---|--------|--------|-----|
| 60 x 40 cm | 1 | 236060 | 52,74€ | |



| Plaque bords droits Tôle acier | | | | P.U |
|--------------------------------|---|--------|--------|-----|
| 40 x 30 cm | 1 | 201393 | 17,41€ | |
| GN1/1 - 32,5 x 53 cm | 1 | 232053 | 20,15€ | |
| 60 x 40 cm | 1 | 236260 | 26,89€ | |

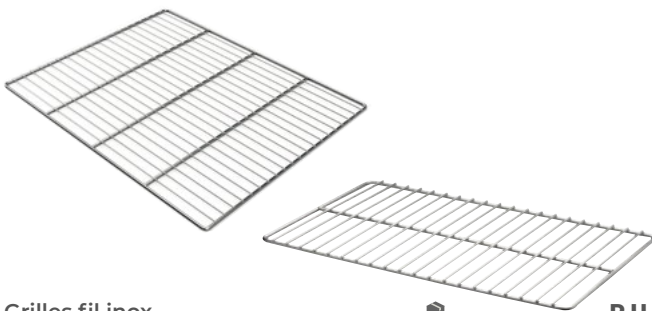

| Grilles fil inox | | | | P.U |
|--|----|--------|--------|-----|
| GN1/1 - 32,5 x 53 cm - cadre + 1 traverse Ø 6 mm + 20 fils Ø 2 mm (sens 325) | 10 | 200016 | 7,54€ | |
| 600 x 400 - cadre + 3 traverses Ø 5 mm + 18 fils Ø 2 mm | 10 | 200017 | 7,36€ | |
| GN2/1 - 65 x 53 cm - cadre + 3 traverses Ø 6 mm + 30 fils Ø 2,40 mm (sens 650) | 10 | 200018 | 16,52€ | |

| Grilles fil inox renforcées | | | | P.U |
|--|----|--------|--------|-----|
| GN1/1 - 32,5 x 53 cm - cadre + 1 traverse Ø 7 mm + 20 fils Ø 3 mm (sens 325) | 10 | 200116 | 9,80€ | |
| 600 x 400 - cadre + 2 traverses Ø 6 mm + 24 fils Ø 3 mm | 10 | 200117 | 14,29€ | |
| GN2/1 - 65 x 53 cm - cadre + 3 traverses Ø 7 mm + 20 fils Ø 3 mm (sens 650) | 10 | 200118 | 16,80€ | |



| Papier cuisson Boîte de 500 | | | | P.U |
|-----------------------------|---|--------|--------|-----|
| GN 1/1 | 1 | 203917 | 21,22€ | |
| 600 x 400 | 1 | 206040 | 30,91€ | |



| Toile de cuisson silicone Température maxi 250°C | | | | P.U |
|--|---|--------|--------|-----|
| GN 1/1 | 1 | 206520 | 17,04€ | |
| 400 x 300 | 1 | 206400 | 13,04€ | |



| Papier de cuisson | | | | P.U |
|---------------------------|---|--------|--------|-----|
| Rouleau de 75 M - L 45 cm | 1 | 206756 | 23,80€ | |

LA PRÉPARATION

Balances



| | | | |
|-----------------|---|--------|---------|
| Balance compact | 1 | 200734 | 180,60€ |
| 15 kg | 1 | 200734 | 180,60€ |



| | | | |
|---|---|--------|--------|
| Balance électronique Plateau inox amovible, pieds réglables, fonctionne sur piles. Protection IP53. | 1 | 200105 | 97,13€ |
| Portée de 5 kg, précision 0,5 g | 1 | 200105 | 97,13€ |
| Portée de 10 kg, précision 1 g | 1 | 200106 | 97,13€ |
| Adaptateur secteur | 1 | 200784 | 9,66€ |
| Pour balance 200105 et 200106 | 1 | 200784 | 9,66€ |



| | | | |
|-------------------|---|--------|--------|
| Balance mécanique | 1 | 203695 | 36,62€ |
| 3 kg | 1 | 203695 | 36,62€ |
| 5 kg | 1 | 203696 | 36,62€ |
| 20 kg | 1 | 203697 | 71,60€ |



| | | | |
|---------------------------------|----|--------|--------|
| Balance de cuisine électronique | 10 | 206757 | 17,57€ |
| 5 kg | 10 | 206757 | 17,57€ |



| | | | |
|---------------------------------|----|--------|--------|
| Mini balance de haute précision | 10 | 206758 | 12,42€ |
| 500 g | 10 | 206758 | 12,42€ |

LA PRÉPARATION

Conservation

Grande résistance à la chaleur : 95°C. Bon comportement aux basses températures : -40°C. Robustesse, hygiène, durabilité. Compatible lave-vaisselle.



Ouverture facile



Prolonge la vie utile de l'aliment. Le couvercle est doté d'un canal qui permet d'extraire partiellement l'air de l'intérieur du conteneur.



Facilite la gestion des aliments dans la cuisine.

colorclip®



| Boîte hermétique en polypropylène | | P.U | |
|-----------------------------------|---|--------|--------|
| GN1/1 H 6,5 cm - 8,3 L | 6 | 202681 | 17,71€ |
| GN1/1 H 10 cm - 13,7 L | 6 | 202682 | 18,84€ |
| GN1/1 H 15 cm - 20,5 L | 6 | 202683 | 22,58€ |
| GN1/1 H 20 cm - 27,5 L | 6 | 202684 | 25,94€ |
| GN1/2 H 6,5 cm - 4 L | 6 | 202674 | 11,63€ |
| GN1/2 H 10 cm - 6,5 L | 6 | 202675 | 13,59€ |
| GN1/2 H 15 cm - 10 L | 6 | 202676 | 16,35€ |
| GN1/2 H 20 cm - 12,5 L | 6 | 202677 | 18,13€ |
| GN1/3 H 6,5 cm - 2,5 L | 6 | 202671 | 7,07€ |
| GN1/3 H 10 cm - 4 L | 6 | 202672 | 9,89€ |
| GN1/3 H 15 cm - 6 L | 6 | 202673 | 10,91€ |
| GN1/4 H 6,5 cm - 1,8 L | 6 | 202667 | 5,68€ |
| GN1/4 H 10 cm - 2,8 L | 6 | 202668 | 6,56€ |
| GN1/4 H 15 cm - 4,3 L | 6 | 202669 | 7,25€ |
| GN1/6 H 6,5 cm - 1,1 L | 6 | 202664 | 4,87€ |
| GN1/6 H 10 cm - 1,7 L | 6 | 202665 | 5,63€ |
| GN1/6 H 15 cm - 2,6 L | 6 | 202666 | 5,88€ |
| GN1/9 H 6,5 cm - 0,6 L | 6 | 202661 | 3,78€ |
| GN1/9 H 10 cm - 1 L | 6 | 202662 | 4,42€ |
| GN1/9 H 15 cm - 1,5 L | 6 | 202663 | 4,71€ |



| Boîte hermétique ABS GN 1/1 - 530 x 325 mm | | P.U | |
|--|---|--------|--------|
| H 6,5 cm - 6,25 L | 6 | 240841 | 28,54€ |
| H 10 cm - 10,90 L | 6 | 240842 | 34,57€ |
| H 15 cm - 17,50 L | 6 | 240843 | 42,09€ |
| H 20 cm - 24 L | 6 | 240844 | 45,43€ |



| Boîte hermétique ABS GN 1/2 - 325 x 265 mm | | P.U | |
|--|---|--------|--------|
| H 6,5 cm - 2,8 L | 6 | 240845 | 15,86€ |
| H 10 cm - 4,85 L | 6 | 240846 | 20,58€ |
| H 15 cm - 7,9 L | 6 | 240847 | 25,26€ |
| H 20 cm - 10,25 L | 6 | 240848 | 28,43€ |



| Boîte hermétique ABS GN 1/3 - 325 x 176 mm | | P.U | |
|--|----|--------|--------|
| H 6,5 cm - 1,65 L | 6 | 240849 | 13,56€ |
| H 10 cm - 3 L | 6 | 240850 | 14,38€ |
| H 15 cm - 4,7 L | 6 | 240851 | 16,91€ |
| H 20 cm - 5 L | 16 | 240852 | 21,08€ |



| Boîte hermétique ABS GN 1/4 - 265 x 162 mm | | P.U | |
|--|----|--------|--------|
| H 6,5 cm - 1,2 L | 16 | 240853 | 11,66€ |
| H 10 cm - 2,2 L | 16 | 240854 | 12,30€ |
| H 15 cm - 3,3 L | 16 | 240855 | 14,04€ |



| Boîte hermétique ABS GN 1/6 - 176 x 162 mm | | P.U | |
|--|----|--------|--------|
| H 6,5 cm - 0,75 L | 16 | 240856 | 9,46€ |
| H 10 cm - 1,25 L | 6 | 240857 | 10,89€ |
| H 15 cm - 1,9 L | 16 | 240858 | 11,09€ |

LES CONTENANTS

Gastronormes

GN 2/1

| BAC | INOX 18/10 | | INOX 18/0 | INOX PERFORÉ | |
|--------|------------|---------|-----------|--------------|---------|
| 2 cm | 222102 | 22,92 € | | | |
| 4 cm | 222104 | 23,61 € | | | |
| 6,5 cm | 222106 | 26,79 € | | 200915 | 42,85 € |
| 10 cm | 222110 | 32,95 € | | 200916 | 53,06 € |
| 15 cm | 222115 | 43,18 € | | | |
| 20 cm | 222120 | 50,08 € | | | |



BAC GASTRONORME INOX 18/10 DE HAUTE QUALITE

Structure solide, bords lisses, faciles à nettoyer. Utilisables dans les fours à convection, les réfrigérateurs, les bains-marie et les chafing disant.

GN 1/1

| BAC | INOX 18/10 | | INOX 18/0 | INOX PERFORÉ | | |
|-------------------------|------------|---------|-----------|--------------|-----------|---------|
| Profondeur | Référence | P.U | Référence | P.U | Référence | P.U |
| 2 cm | 221103 | 10,07 € | 206759 | 7,68 € | | |
| 4 cm | 221104 | 11,92 € | 206760 | 8,87 € | | |
| 5,5 cm | 221105 | 12,51 € | 206761 | 10,97 € | 299382 | 20,38 € |
| 6,5 cm | 221106 | 12,63 € | 206762 | 10,34 € | | |
| 10 cm | 221110 | 16,93 € | 206763 | 13,50 € | 221111 | 28,77 € |
| 15 cm | 221115 | 23,02 € | 206764 | 20,25 € | 221112 | 43,64 € |
| 20 cm | 221120 | 28,18 € | 206765 | 24,80 € | 299380 | 50,26 € |
| Couvercle | 221101 | 12,39 € | | | | |
| - étanche | 200645 | 41,19 € | | | | |
| Barrette de composition | 221117 | 4,40 € | | | | |

GN 2/3

| BAC | INOX 18/10 | | INOX 18/0 | INOX PERFORÉ | |
|-----------|------------|---------|-----------|--------------|---------|
| 6,5 cm | 222306 | 13,30 € | | 200917 | 20,62 € |
| 10 cm | 222301 | 15,97 € | | 200918 | 29,42 € |
| 15 cm | 222315 | 23,01 € | | | |
| 20 cm | 222320 | 30,55 € | | | |
| Couvercle | 222303 | 10,54 € | | | |



COUVERCLES INOX

GN 1/2

| BAC | INOX 18/10 | | INOX 18/0 | INOX PERFORÉ | | |
|-------------------------|------------|---------|-----------|--------------|--------|---------|
| 2 cm | 221202 | 6,56 € | 206766 | 3,80 € | | |
| 4 cm | 221204 | 7,89 € | 206767 | 5,24 € | | |
| 6,5 cm | 221206 | 9,22 € | 206768 | 6,08 € | 200919 | 18,22 € |
| 10 cm | 221210 | 11,79 € | 206769 | 8,27 € | 200920 | 22,45 € |
| 15 cm | 221215 | 14,65 € | 206770 | 12,77 € | | |
| 20 cm | 221220 | 19,27 € | 206771 | 15,45 € | | |
| Couvercle | 221201 | 7,31 € | | | | |
| - étanche | 200646 | 30,41 € | | | | |
| Barrette de composition | 221118 | 3,15 € | | | | |

GN 1/3

| BAC | INOX 18/10 | | INOX 18/0 | | |
|-----------|------------|---------|-----------|---------|--|
| 2 cm | 221303 | 6,49 € | 206772 | 3,12 € | |
| 4 cm | 221304 | 7,89 € | 206773 | 4,47 € | |
| 6,5 cm | 221306 | 7,57 € | 206774 | 4,65 € | |
| 10 cm | 221310 | 9,49 € | 206775 | 6,50 € | |
| 15 cm | 221315 | 14,56 € | 206776 | 8,87 € | |
| 20 cm | 221320 | 17,58 € | 206777 | 11,73 € | |
| Couvercle | 221301 | 6,45 € | | | |
| - étanche | 200647 | 25,16 € | | | |



BAC INOX PERFORÉE

GN 1/4

| BAC | INOX 18/10 | | INOX 18/0 | | |
|-----------|------------|---------|-----------|---------|--|
| 2 cm | 221403 | 5,34 € | 206778 | 3,12 € | |
| 4 cm | | | 206779 | 4,29 € | |
| 6,5 cm | 221406 | 7,73 € | 206780 | 4,20 € | |
| 10 cm | 221410 | 8,19 € | 206781 | 5,57 € | |
| 15 cm | 221415 | 11,68 € | 206782 | 8,60 € | |
| 20 cm | 221420 | 15,74 € | 206783 | 10,20 € | |
| Couvercle | 221401 | 5,04 € | | | |
| - étanche | 200648 | 22,46 € | | | |

GN 1/6

| BAC | INOX 18/10 | | INOX 18/0 | | |
|-----------|------------|---------|-----------|--------|--|
| 6,5 cm | 221606 | 6,56 € | 206784 | 3,08 € | |
| 10 cm | 221610 | 7,86 € | 206785 | 4,44 € | |
| 15 cm | 221615 | 11,57 € | 206786 | 6,75 € | |
| 20 cm | 221620 | 14,68 € | 206787 | 8,36 € | |
| Couvercle | 221601 | 5,03 € | | | |
| - étanche | 200649 | 22,46 € | | | |



Pince pour plat chaud
En acier inoxydable

18,5 cm 6 201830 4.51€

GN 1/9

| BAC | INOX 18/10 | | | |
|-----------|------------|--------|--------|--------|
| 6,5 cm | 221906 | 4,86 € | 206788 | 2,63 € |
| 10 cm | 221910 | 7,12 € | 206789 | 3,98 € |
| Couvercle | 221901 | 4,44 € | | |

LES CONTENANTS

Gastronormes

| GN 2/1 | | BAC | COPOLYESTER | | | |
|--------|------------|-----|-------------|---------|---------------|---------|
| | 15 cm | | 200664 | 70,40 € | | |
| | 20 cm | | 200665 | 82,11 € | | |
| | Couvercle | | 200666 | 43,62 € | | |
| GN 1/1 | | BAC | COPOLYESTER | | POLYPROPYLENE | |
| | Profondeur | | Référence | P.U | Référence | P.U |
| | 6,5 cm | | 200667 | 12,96 € | 256013 | 6,71 € |
| | 10 cm | | 200668 | 16,35 € | 256070 | 8,29 € |
| | 15 cm | | 200669 | 19,99 € | 256018 | 10,63 € |
| | 20 cm | | 200670 | 25,59 € | 205711 | 14,00 € |
| | Couvercle | | 200671 | 12,50 € | 200650 | 6,07 € |
| | Égouttoir | | 200672 | 10,01 € | 205703 | 6,03 € |
| GN 2/3 | | BAC | COPOLYESTER | | POLYPROPYLENE | |
| | 15 cm | | | | 256012 | 13,24 € |
| | 10 cm | | | | 256080 | 10,85 € |
| | Couvercle | | | | 256502 | 5,35 € |
| GN 1/2 | | BAC | COPOLYESTER | | POLYPROPYLENE | |
| | 6,5 cm | | 200673 | 7,36 € | 256040 | 4,00 € |
| | 10 cm | | 200674 | 9,34 € | 256060 | 5,04 € |
| | 15 cm | | 200675 | 11,96 € | 256075 | 6,39 € |
| | 20 cm | | 200676 | 14,48 € | 205715 | 7,94 € |
| | Couvercle | | 200677 | 6,06 € | 200651 | 3,52 € |
| | Égouttoir | | 200678 | 3,93 € | 205704 | 2,86 € |
| GN 1/3 | | BAC | COPOLYESTER | | POLYPROPYLENE | |
| | 6,5 cm | | 200679 | 5,67 € | 200644 | 3,09 € |
| | 10 cm | | 200680 | 7,24 € | 256035 | 3,77 € |
| | 15 cm | | 200681 | 9,03 € | 256050 | 4,91 € |
| | 20 cm | | | | 205712 | 6,03 € |
| | Couvercle | | 200682 | 4,42 € | 200652 | 2,58 € |
| | Égouttoir | | 200683 | 2,73 € | 205705 | 2,70 € |
| GN 1/4 | | BAC | COPOLYESTER | | POLYPROPYLENE | |
| | 6,5 cm | | 200921 | 5,78 € | 201400 | 2,81 € |
| | 10 cm | | 200684 | 5,57 € | 201401 | 2,86 € |
| | 15 cm | | 200685 | 7,49 € | 201402 | 3,95 € |
| | Couvercle | | 200686 | 3,30 € | 201403 | 2,06 € |
| | Égouttoir | | 200687 | 3,60 € | 205706 | 2,21 € |
| GN 1/6 | | BAC | COPOLYESTER | | POLYPROPYLENE | |
| | 6,5 cm | | 200688 | 3,18 € | 201405 | 1,86 € |
| | 10 cm | | 200689 | 4,00 € | 201406 | 2,15 € |
| | 15 cm | | 200922 | 6,31 € | 201407 | 2,80 € |
| | Couvercle | | 200691 | 2,55 € | 201408 | 1,36 € |
| | Égouttoir | | 200692 | 1,43 € | 205709 | 1,45 € |
| GN 1/9 | | BAC | COPOLYESTER | | POLYPROPYLENE | |
| | 6,5 cm | | 200693 | 4,03 € | 201410 | 2,29 € |
| | 10 cm | | 200694 | 4,44 € | 201411 | 2,44 € |
| | Couvercle | | 200695 | 2,08 € | 201412 | 1,20 € |
| | Égouttoir | | | | 205710 | 1,15 € |



BAC GASTRONORME COPOLYESTER

Pour aliments chauds ou froids. Sans bisphénol A, conforme aux exigences de la réglementation. Tenue en température de - 40° à + 90°C. Transparent cristal. 100 % recyclable.



BÔTE GASTRONORME POLYPROPYLENE

Idéal pour le transport et la cuisson en micro-ondes.

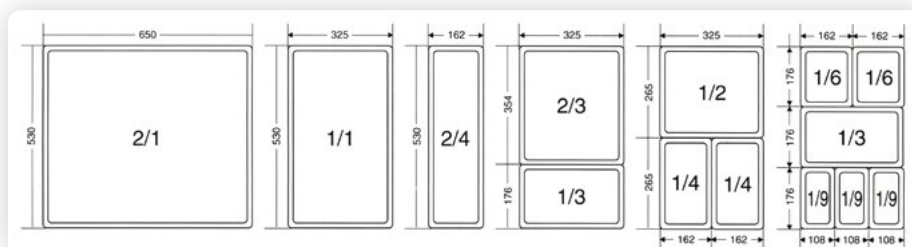

RÉCEPTION, STOCKAGE et Manutention



Chariot cafétéria pour 12 plateaux
Plateaux standards : 46 x 36 cm, 48 x 37 cm, GN 1/1 53 x 32,5 cm et fast food 35 x 27 cm. Charge max. par niveau : 5 kg. 51 x 62 x 170 cm. Espace entre glissières : 10,8 cm. Entrée 37,5 cm

| | | | P.U |
|-------------------|---|--------|---------|
| 2 panneaux bleus | 1 | 203101 | 959,61€ |
| 2 panneaux verts | 1 | 203102 | 953,91€ |
| 2 panneaux rouges | 1 | 203103 | 953,91€ |



Chariot cafétéria
En acier inoxydable. Montants tubes carrés 2,5 x 2,5 cm. 4 roues pivotantes Ø 12,5 cm, dont 2 à frein, à chape polyamide

| | | | P.U |
|--|---|--------|---------|
| Sens largeur : 51 x 63 x 179 cm : 1 x 12 niveaux | 1 | 200112 | 403,10€ |
| Sens largeur : 93 x 63 x 179 cm : 2 x 12 niveaux | 1 | 200324 | 569,40€ |



Chariot à glissières gastronome
En acier inoxydable. Montants tubes carrés 2,5 x 2,5 cm. 4 roues pivotantes Ø 12,5 cm, dont 2 à frein, à chape polyamide

| | | | P.U |
|-----------------------------------|---|--------|---------|
| GN 1/1, 20 glissières, H 178,5 cm | 1 | 200015 | 216,00€ |
| GN 2/1, 20 glissières, H 178,5 cm | 1 | 200220 | 234,00€ |

Entrée double, côte à côte pour 24 plateaux
Plateaux standards : 46 x 36 cm, à 48 x 37 cm, GN 1/1 53 x 32,5 cm et fast food 35 x 27 cm. Charge max. par niveau : 5 kg. 92,5 x 62 x 170 cm. Espace entre glissières : 10,8 cm. Entrée 37,5 cm.

| | | | P.U |
|-------------------|---|--------|----------|
| 2 panneaux bleus | 1 | 203104 | 1350,33€ |
| 2 panneaux verts | 1 | 203105 | 1350,32€ |
| 2 panneaux rouges | 1 | 203106 | 1342,19€ |



| | | | P.U |
|--------------------------|---|--------|---------|
| L 800 mm - Ø 300 mm maxi | 1 | 205679 | 144,16€ |



Chariot à glissières
Avec tablette, 8 niveaux, en acier inoxydable. Tubes carrés 2,5 x 2,5 cm. 4 roues pivotantes Ø 12,5 cm, dont 2 à frein, à chape polyamide avec roulement à billes.

| | | | P.U |
|----------------------------------|---|--------|---------|
| GN1/1 - 65,5 x 45,5 cm - H 90 cm | 1 | 203679 | 223,60€ |
| GN2/1 - 77,5 x 66 cm - H 90 cm | 1 | 203680 | 270,64€ |

Chariot à glissières encastrable

| | | | P.U |
|--------------------------------------|---|--------|---------|
| GN1/1 - 65,5 x 45,5 cm - H 178,50 cm | 1 | 201621 | 482,79€ |
| GN2/1 - 77,5 x 66 cm - H 178,50 cm | 1 | 201622 | 583,80€ |

RÉCEPTION, STOCKAGE et Manutention



Chariot de service 3 plateaux polyéthylène **P.U**

Charge maximale 120 kg 103 x 50 x 96 cm 1 **201623 135,30€**



Chariot soudé avec plate-forme réhaussée Grilles de séparation anti-chute **P.U**

Chariot 200 assiettes - 1065 x 450 x 1000 mm 1 **200696 390,32€**

Chariot 400 assiettes - 1065 x 740 x 1000 mm 1 **200697 558,96€**



Housse lavable en PVC 2 fermetures à glissières verticales **P.U**

Housse lavable GN 1/1 1 **204023 82,53€**

Housse lavable GN 2/1 1 **204105 83,16€**

Lot de 100 housses jetables **P.U**

Pour chariots GN 1/1 1 **204025 148,00€**

Lot de 50 housses jetables **P.U**

Pour chariots GN 2/1 1 **204026 177,00€**



Chariot à débarrasser avec 2 arceaux inox **P.U**

2 plateaux 80 x 53 cm 1 **200014 183,00€**

3 plateaux 80 x 53 cm 1 **200013 216,00€**

2 plateaux 100 x 60 cm 1 **200914 260,37€**

3 plateaux 100 x 60 cm 1 **200913 311,02€**

Housse pour chariot à débarrasser **P.U**

85 x 58 x 78 cm 1 **204027 102,20€**

105 x 65 x 78 cm 1 **204103 102,20€**



Chariot de stockage égouttage bacs gastro **P.U**

3 niveaux 1 **200006 1070,85€**

4 niveaux 1 **200007 1283,70€**



Housse pour chariot porte assiettes **P.U**

200 assiettes 1 **204029 72,00€**

400 assiettes 1 **205681 82,00€**



Rouleau de 200 housses jetables **P.U**

GN 1/1 - Qualité alimentaire 2/100e 1 **200042 100,71€**



Rouleau de 200 housses jetables **P.U**

GN 2/1 1 **202440 112,34€**

RÉCEPTION, STOCKAGE et Manutention



Chariot plate-forme à claires voies
En aluminium **P.U**

1000 x 600 mm
- 4 roues Ø 160 mm,
2 fixes, 2 pivotantes **200527 491,15€**



Chariot plate-forme à dessus plein
En aluminium **P.U**

1000 x 600 mm
- 4 roues Ø 160 mm,
2 fixes, 2 pivotantes **200528 604,65€**



Cuve sur roues polyéthylène
Avec bouchon de vidange, 4 roues : 2
fixes, 2 pivotantes Ø 16 cm **P.U**

120 x 80 cm x H 80 cm - 310 L **203683 737,10€**

121 x 80 cm x H 109,5 cm - 500 L **205682 1057,56€**



Housse de protection antibactérienne **P.U**

Pour bacs 310 L et 500 L **205684 94,81€**

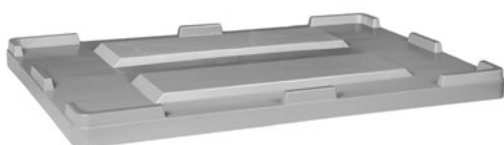

Couvercle rigide **P.U**

Pour bacs 310 L et 500 L **205683 135,24€**

Chariot à poignée
Charge maxi 150 kg **P.U**

74 x 48 cm **200821 109,51€**



Cuve sur roues
Acier inoxydable, avec grille crépine
et bonde surverse. 4 roues pivotantes
Ø 12,5 cm, dont 2 à frein. 140 L **P.U**

81 x 56 cm x H 54 cm **203682 791,70€**



Cuvier GN encastrable **P.U**

74 x 62,5 x H 85 cm **203744 299,20€**



RÉCEPTION, STOCKAGE et Manutention



Rayonnage Fermostock 5711
Solution économique pour vos stockages en chambre froide. Supporte une charge maximum uniformément répartie de 120 kg par niveau. Clayettes amovibles en polymère. Structure en Duralinox. 4 niveaux.

| Rayonnage Fermostock 5711 | P.U |
|---|--------------------------------|
| 119 cm x 36 cm x H 168,5 cm (dim. Compatible gastronomique) | 1 201363 280,00€ |
| 119 cm x 46 cm x H 168,5 cm | 1 201364 270,30€ |



| Rayonnage 5 niveaux | P.U |
|-------------------------|--------------------------------|
| Avec 1 bac de rétention | 1 205685 505,15€ |



| Porte étiquette | P.U |
|-----------------|----------------------------|
| 1 | 201527 4,73€ |



Rayonnage Fermostock 6622
Pour vos stockages en réserve sèche et cuisine. Profondeur 46 cm - H 180 cm. Supporte une charge maximum uniformément répartie de 200 kg par niveau. Clayettes pleines amovibles en polymère. 3 niveaux.

| Longueur | P.U |
|----------|--------------------------------|
| 65,7 cm | 1 201414 207,61€ |
| 77,7 cm | 1 201415 214,40€ |
| 89,7 cm | 1 201416 229,51€ |
| 95,7 cm | 1 201417 239,02€ |
| 107,7 cm | 1 201418 251,41€ |
| 119,7 cm | 1 201419 263,63€ |
| 131,7 cm | 1 201420 274,76€ |
| 149,7 cm | 1 201421 295,04€ |



| Rayonnage 4 niveaux | P.U |
|---------------------|--------------------------------|
| 46 x 76 x 183 | 1 206793 234,89€ |
| 46 x 91 x 183 | 1 206794 253,18€ |
| 46 x 107 x 183 | 1 206795 286,74€ |
| 46 x 122 x 183 | 1 206796 298,95€ |
| 46 x 138 x 183 | 1 206797 326,40€ |
| 46 x 153 x 183 | 1 206798 350,80€ |
| 46 x 1830 x 1830 | 1 206799 460,62€ |



Rayonnage Fermostock 6611
Solution premium pour vos stockages en chambre froide. Supporte une charge maximum uniformément répartie de 175 kg par niveau. Clayettes amovibles en polymère. Structure en Duralinox. 4 niveaux.

| Rayonnage Fermostock 6611 | P.U |
|---|--------------------------------|
| 119,7 cm x 36 cm x H 168,5 cm (dim. compatible gastronomique) | 1 201365 314,00€ |
| 119,7 cm x 46 cm x H 168,5 cm | 1 201366 306,22€ |



Bacs de rétention pour rayonnages et chariots sous table Fermostock 6611/6622
Pour stockage des produits d'entretien ou lessiviels.

| Pour niveaux P : 46 cm | P.U |
|------------------------|--------------------------------|
| L : 119,7 cm | 1 202280 193,71€ |



| Chariot sous table | P.U |
|---------------------------|--------------------------------|
| 95,7 cm x 46 cm x H 58 cm | 1 206792 230,00€ |

RÉCEPTION, STOCKAGE et Manutention



Manne à pain
ajourée empilable et
emboîtable

Beige P.U

120 L - Compact 64 x 45
x 55,5 cm 1 **202003 74,98€**

150 L - 66,5 x 46 x 71,5 cm 2 **205686 93,49€**

180 L - 66,1 x 46,5 x 83
cm 1 **260523 106,86€**



Fût P.U

30 L 1 **205687 36,65€**

50 L 1 **204114 51,79€**

100 L 1 **204115 97,14€**



Patière 170 L P.U

PEHD. Poids : 8,5 kg.
Dim. ext. : 93 x 67 x H
41,1 cm Dim. int. : 77 x
54 x H 40 cm 1 **204116 218,50€**



Couvercle pour
patière 170 L P.U

71 x 97,5 cm - H 5,5
cm 1 **206034 137,20€**



Bac rond
emboîtable P.U

35 L - Ø 47,5 cm 1 **260835 24,72€**

50 L - Ø 54,5 cm 1 **260850 35,69€**

75 L - Ø 62 cm 1 **260875 47,41€**



Bac rond
emboîtable P.U

19 L - Ø 48 cm 1 **260819 13,45€**



Chariot inox pour
patière 170 L P.U

65 x 75 cm - H 90 cm 1 **206035 973,01€**



Seau rond gradué à
bec verseur P.U

Anse inox, usage
alimentaire. Ø 29 cm, 1 **260112 19,81€**
H 31 cm.



Couvercle pour
seau rond 12 L avec
bec verseur P.U

Ø 29/32 cm - H 2 cm 1 **206036 5,44€**



Seau inox gradué
à pied P.U

12 L 1 **205689 126,19€**

RÉCEPTION, STOCKAGE et Manutention

Le couvercle reste en position relevée, sans avoir à le tenir et permet une ouverture totale même avec une autre boîte empliée.

L'étiquette intégrée et la transparence permettent une identification rapide de l'aliment. Étiquette permanente de traçabilité : elle permet d'enregistrer la provenance de l'aliment, son élaboration, la date de conservation. La boîte Accessible 1/1 est conçue avec le système FIFO (ce qui entre en premier, sort en premier) et le couvercle de charge et de décharge. Recommandation HACCP.

- ColorClip : code de couleur pour éviter la contamination croisée des aliments.
- Anses latérales : pour une manipulation et transport faciles.
- Bords arrondis : la conception spéciale évite que les restes s'accumulent et facilite le nettoyage.
- Roulettes résistantes en polyamide, dans les dimensions 80 L et 100 L pour faciliter le transport.



| Pelle à mesurer | | | P.U |
|-----------------|---|--------|-------|
| 50 cl | 1 | 237020 | 3,05€ |
| 75 cl | 1 | 204516 | 3,79€ |
| 100 cl | 1 | 237021 | 4,74€ |
| 200cl | 1 | 299777 | 5,75€ |

| Boîte à ingrédients | | | P.U |
|--|---|--------|--------|
| 39,5 x 20 x 20 cm, 7 L | 6 | 202686 | 8,94€ |
| 48 x 23 x 22,7 cm, 14 L | 6 | 202685 | 13,10€ |
| 41,5 x 34 x 20 cm, 16 L | 6 | 202687 | 16,33€ |
| 56,5 x 34 x 20 cm, 22,65 L charge et décharge indépendante | 6 | 202691 | 18,12€ |



Bac à ingrédients avec couvercle + 4 roues P.U

Poids : 6,6 kg. Dim. ext. : 72,5 x 41 x H 67,5 cm Dim. int. : 62 x 31,5 x H 57,5 cm 1 202000 213,43€



3 bacs à ingrédients avec couvercle + 4 roues P.U

Poids : 5,71 kg Dim. ext. : 56,5 x 31,5 x H 99 cm Dim. int. : 50 x 27,5 x H 29,5 cm 1 205688 212,86€



Bac à ingrédients sans couvercle + 4 roues P.U

Poids : 4,2 kg Dim. ext. : 62,1 x 40 x H 66 cm Dim. int. : 51,5 x 33,5 x H 56 cm 1 202500 83,98€

| Boîte à ingrédients | | | P.U |
|--|---|--------|--------|
| Poids : 2,28 kg. Dim. ext. : 58,3 x 39,8 x H 44,2 cm Dim. int. : 36,5 x 33,8 x H 43,5 cm | 1 | 204123 | 22,87€ |



| Couvercle pour bac à ingrédients 40L et 80L | | Transparent | Blanc | Beige | Bleu | Jaune | Rouge | Vert | P.U |
|---|---|-------------|--------|--------|--------|--------|--------|--------|--------|
| | 1 | 204124 | 204125 | 204126 | 204127 | 204128 | 204129 | 204130 | 12,19€ |

RÉCEPTION, STOCKAGE et Manutention

Bac gerbable HACCP
Bac gerbable alimentaire
+ couvercle. Cartouche
d'identification sur les
bacs permettant d'annoter
clairement les informations
essentielles à une bonne
gestion et traçabilité de vos
denrées alimentaires.



| Bac gerbable HACCP | | Blanc | Rouge | Bleu | Vert | Jaune | P.U |
|-------------------------|---|--------|--------|--------|--------|--------|--------|
| 60 x 40 x 23 cm, 35 L | 1 | 204118 | 204119 | 204120 | 204121 | 204122 | 42,89€ |
| 40 x 30 x 21,5 cm, 15 L | 1 | 200115 | 219609 | 219610 | 219611 | 219618 | 26,68€ |
| 60 x 40 x 16,5 cm, 25 L | 1 | 200125 | 200325 | 200425 | 200525 | 200625 | 43,36€ |
| 60 x 40 x 32 cm, 55 L | 1 | 200155 | 200355 | 200455 | 200555 | 200655 | 59,21€ |



| Caisse liaison froide ajourée 27 litres | | P.U |
|--|---|---------------|
| Rouge | 1 | 203452 18,53€ |
| Vert | 1 | 203451 18,53€ |
| Bleu | 1 | 203453 18,53€ |
| Blanc | 1 | 203454 18,53€ |
| Jaune | 1 | 203455 18,53€ |

| Caisse liaison froide ajourée 37 litres | | P.U |
|--|---|---------------|
| Rouge | 1 | 203457 19,37€ |
| Vert | 1 | 203456 19,37€ |
| Bleu | 1 | 203458 19,37€ |
| Blanc | 1 | 203459 19,37€ |
| Jaune | 1 | 203460 19,37€ |



| Bac gerbable alimentaire | | Blanc | P.U |
|-----------------------------|---|--------|--------|
| 40 x 30 x 21,5 cm, 15 L | 1 | 201715 | 11,81€ |
| 60 x 40 x 16,5 cm, 25 L | 1 | 201725 | 18,53€ |
| 60 x 40 x 21,5 cm, 35 L | 1 | 201735 | 20,24€ |
| 60 x 40 x 32 cm, 55 L | 1 | 201755 | 25,80€ |



| Couvercle blanc | | Blanc | P.U |
|-------------------------------|---|--------|--------|
| Pour bac 15 L | 1 | 201716 | 5,44€ |
| Pour bacs 25 L, 35 L, 55 L | 1 | 201726 | 11,69€ |

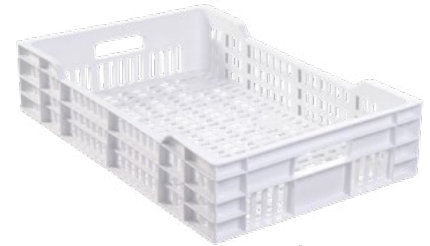

| Bac gerbable ajouré | | Blanc | P.U |
|---------------------|---|--------|--------|
| 60 x 40 x 8,5 cm | 1 | 279321 | 13,36€ |
| 60 x 40 x 13,5 cm | 1 | 279521 | 16,93€ |
| 60 x 40 x 20 cm | 1 | 279621 | 22,87€ |
| 60 x 40 x 30 cm | 1 | 279721 | 26,46€ |



| Caisse ajourée empilable 600 x 400 | | Vert | P.U |
|---------------------------------------|---|--------|--------|
| 25 L | 1 | 206800 | 19,01€ |
| 40 L | 1 | 206801 | 22,80€ |
| 60 L | 1 | 206802 | 28,50€ |



| Caisse ajourée emboîtable 600 x 400 | | Vert | P.U |
|--|---|--------|--------|
| 27 L | 1 | 206803 | 19,01€ |
| 37 L | 1 | 206804 | 20,90€ |



| Grille pour bac | | Blanc | P.U |
|--|---|--------|-------|
| Pour bac 600 X 400 mm - 51,5 x 32 x 17 cm | 1 | 206805 | 5,21€ |

RÉCEPTION, STOCKAGE et Manutention



Cuvette carrée
Emboîtable sans effet de
ventouse grâce aux ergots.



P.U

| | | | |
|-------------------------|---|---------------|---------------|
| 10L - 35 x 35 x 13,5 cm | 1 | 205740 | 13,13€ |
| 12L - 39 x 39 x 14 cm | 1 | 205739 | 13,69€ |



Sachets plat
témoin



P.U

| | | | |
|-------------|---|---------------|----------------|
| Lot de 1000 | 1 | 200011 | 109,63€ |
|-------------|---|---------------|----------------|



Bac plat HACCP +
couvrete + grille



Blanc



Bleu



Rouge



Vert

P.U

| | | | | | | |
|-----|---|---------------|---------------|---------------|---------------|---------------|
| 3 L | 1 | 205690 | 205692 | 205691 | 205693 | 11,97€ |
| 5 L | 1 | 205694 | 205696 | 205695 | 205697 | 16,26€ |
| 8 L | 1 | 205698 | 205700 | 205699 | 205701 | 20,62€ |



Bac à pâtons



Blanc

P.U

| | | | |
|--------------------------|---|---------------|---------------|
| 53 x 32,5 x 9 cm, GN 1/1 | 1 | 202508 | 11,09€ |
| 60 x 40 x 5,5 cm, 9 L | 1 | 202507 | 10,73€ |
| 60 x 40 x 8,5 cm, 15 L | 1 | 279421 | 11,43€ |



Bac plat
rectangulaire
emboîtable



Blanc

P.U

| | | | |
|-------------------------|---|---------------|--------------|
| 30 x 20,5 x 6,5 cm, 2 L | 1 | 254121 | 2,60€ |
| 35 x 23,5 x 7,3 cm, 3 L | 1 | 254221 | 3,71€ |
| 43,5 x 28,5 x 8 cm, 5 L | 1 | 254321 | 5,60€ |
| 49 x 33,5 x 8 cm, 8 L | 1 | 254421 | 7,52€ |
| 54 x 38,5 x 8 cm, 10 L | 1 | 254521 | 9,38€ |



Grille pour bac



Blanc

P.U

| | | | |
|------|---|---------------|--------------|
| 2 L | 1 | 202502 | 0,98€ |
| 3 L | 1 | 202503 | 1,32€ |
| 5 L | 1 | 202504 | 2,01€ |
| 8 L | 1 | 202505 | 2,68€ |
| 10 L | 1 | 202506 | 3,74€ |



Marqueurs noirs
effaçables à l'eau



P.U

| | | | |
|-----------|---|---------------|---------------|
| Lot de 10 | 1 | 206037 | 18,36€ |
|-----------|---|---------------|---------------|



Couvrete pour bac



Blanc

P.U

| | | | |
|--------------------|---|---------------|--------------|
| 35 x 23,5 cm - 3L | 1 | 260151 | 3,55€ |
| 49 x 33,5 mm - 5 L | 1 | 260241 | 4,15€ |
| 49 x 33,5 mm - 8 L | 1 | 260341 | 4,79€ |
| 49 x 34 mm - 10 L | 1 | 205112 | 5,59€ |



Bac plat ABS



Transparent

P.U

| | | | |
|-----|---|---------------|---------------|
| 3 L | 1 | 206806 | 5,10€ |
| 5 L | 1 | 206807 | 7,71€ |
| 8 L | 1 | 206808 | 10,37€ |

RÉCEPTION, STOCKAGE et Manutention



Palette de stockage **P.U**

| | | | |
|---------------------------|---|---------------|---------------|
| 700 kg 60 x 80 x 13 cm | 1 | 202004 | 22,99€ |
| 650 kg 120 x 80 x 14,7 cm | 1 | 200547 | 40,31€ |



Caillebotis **P.U**

| | | | |
|------------------------------|---|---------------|---------------|
| 50 x 50 cm, épaisseur 2,2 cm | 1 | 203413 | 11,45€ |
| 50 x 50 cm, épaisseur 5 cm | 1 | 201061 | 18,18€ |



Socle 6 roues ABS Charge 250 kg, H 13,5 cm. Bandage élastomère, visserie et palier acier. **P.U**

| | | | |
|---|---|---------------|---------------|
| Pour bac 600 X 400 mm - 61,3 x 41,4 x 17,2 cm | 1 | 203433 | 49,56€ |
|---|---|---------------|---------------|



Socle 4 roues ABS Charge 250 kg. Roues pivotantes avec chape acier. **P.U**

| | | | |
|-----------------------|---|---------------|---------------|
| 61,3 x 41,4 x 17,2 cm | 1 | 202509 | 50,23€ |
|-----------------------|---|---------------|---------------|



Socle rouleur 4 roues silence pivotantes + 2 freins **P.U**

| | | | |
|--|---|---------------|----------------|
| Charge 250 kg. Chape inox. Compatible avec les bacs 600x400. | 1 | 205702 | 185,37€ |
|--|---|---------------|----------------|

| | | | |
|-----------------------|---|---------------|----------------|
| 61,3 x 41,4 x 17,2 cm | 1 | 205702 | 185,37€ |
|-----------------------|---|---------------|----------------|



Socle et conteneur en polyéthylène Avec couvercle **P.U**

| | | | |
|--------------------|---|---------------|----------------|
| Ø 49,5 cm - 75,7 L | 1 | 204064 | 175,17€ |
|--------------------|---|---------------|----------------|



Timon universel Complément pour socles rouleurs, 4 et 6 roues. Une résistance à la charge optimale.

| | | | |
|-----------------|---|---------------|---------------|
| Timon universel | 1 | 201519 | 92,76€ |
|-----------------|---|---------------|---------------|



Conteneur emboîtable alimentaire Blanc **P.U**

| | | | |
|-------------------------------|---|---------------|---------------|
| 75 L - Ø 54 cm - 67,54 x 48,5 | 1 | 201086 | 41,29€ |
|-------------------------------|---|---------------|---------------|

Couvercle pour conteneur Blanc **P.U**

| | | | |
|-------------------|---|---------------|---------------|
| Ø 56 cm x H 16 cm | 1 | 201117 | 14,51€ |
|-------------------|---|---------------|---------------|

Socle rond 5 roues **P.U**

| | | | |
|------------|---|---------------|---------------|
| Sans timon | 1 | 202510 | 61,02€ |
|------------|---|---------------|---------------|

DISTRIBUTION

Boisson chaude



Machine à café Excelso
Livrée avec une verseuse en verre et un porte-filtre. Elle est équipée de deux plaques de maintien en température. Capacité horaire : 18 L (env. 144 tasses). Temps d'écoulement : 5-6 mn

19 x 37 x 43,3 cm 1 **200810** **316,07€**



Machine à café conteneur 10 L
Machine à résistance électrique transportable à droite. Tableau de commande avec écran tactile, programmeur incorporé, sécurité de positionnement du bras d'écoulement, signal sonore de fin de production, indicateur de détartrage. Capacité horaire café : 60 l. A utiliser avec des filtres 152/457 - Réf 01116. Tension / Puissance Elec, TRI400V+N+T/6,2 kW

Modèle MCC/R L 59 cm x P 47 cm x H 79 cm 1 **205718** **2205€**



Machine à café Excelso T
Livrée avec un thermos de 2 litres et un porte-filtre. Tout inox. Capacité horaire : 18 L (env. 144 tasses). Temps d'écoulement : 6-7 mn

19 x 37 x 47,7 cm 1 **200811** **331,35€**



Machine à thermos "MT100"
Branchement sur arrivée d'eau : non. Capacité horaire café : 144 tasses. Capacité horaire eau chaude : 18 litres. Alimentation électrique : 1N~220-240 V - 50-60Hz / 2 100 W. Temps de production : env. 7,5 min. Filtres corbeille : 90/250

Vendu sans pichet

20,5 x 38 x 59,5 - 18 litres 1 **203164** **370,50€**



Chaque-briques 1 **205719** **1062,60€**



Verseuse 4 **260216** **18,20€**



Verseuse 4 **260237** **36,96€**



Nettoyant 1 **205717** **63,00€**



Détartrant sachet 1 **205716** **63,00€**



Livré
avec pince
à briques



Chauffe-briques
Modèle MPW-3 Pas d'eau, donc pas d'entartrage. Temps de chauffe à 80° C env. 18 mn. 230 V~50 / 60 Hz, 2 190 W

| | | | P.U |
|-------------------|---|--------|---------|
| 27 x 15 x H 24 cm | 1 | 203169 | 623,08€ |



| | | | P.U |
|--------------------------------|-----|--------|--------|
| Pince à briques | 1 | 205720 | 26,60€ |
| Nettoyant dépôt de lait | 1 L | 205721 | 14,00€ |



| | | | P.U |
|------------------------------|---|--------|----------|
| Laitière à bain-marie | | | |
| 5 L, 20,6 x 42,8 cm | 1 | 260405 | 676,70€ |
| 10 L, 27,4 x 42,4 cm | 1 | 260410 | 1023,89€ |
| 20 L, 34,6 x 50,1 cm | 1 | 260420 | 1319,90€ |



Chauffe-eau de table simple paroi, en inox, équipé d'un robinet anti-goutte avec jauge, une sécurité contre la chauffe-à-sec et un thermostat réglable 0-97°C.



| | | | P.U |
|--|---|--------|---------|
| 10 L remplissage manuel - 22,5 x 50,5 cm | 1 | 203813 | 650,75€ |
| 20 L remplissage manuel - 30,5 x 56 cm | 1 | 203814 | 864,00€ |
| 3 L - 21,5 x 28 x H 44,5 cm | 1 | 206809 | 536,20€ |
| 5 L - 21,5 x 28 x H 57,5 cm | 1 | 206810 | 582,40€ |



| | | | P.U |
|---|---|--------|---------|
| Container à résistance électrique Sans jauge, empilable | | | |
| 4 litres, avec anses | 1 | 201325 | 443,94€ |
| 10 litres, avec poignées | 1 | 201326 | 511,20€ |

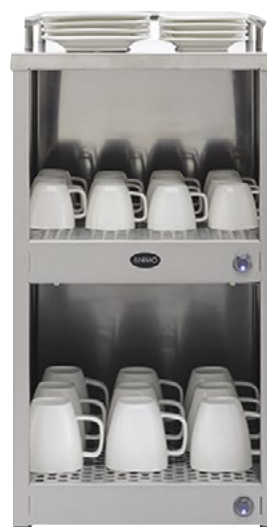

| | | | P.U |
|---|---|--------|---------|
| Chauffe-tasses Capacité +/- 144 tasses empilables | | | |
| Capacité +/- 144 | 1 | 201327 | 558,60€ |

DISTRIBUTION

Petit déjeuner



Chariot monobloc

Capacité : 12 plateaux 1/1 + 2 bacs (H 10 cm) ou 14 plateaux 1/1 ou 24 plateaux 1/2 + 2 bacs (H 10 cm) ou 28 plateaux 1/2 si pas de bacs. Espace entre glissières : 9,8 cm. Roues composite Ø 12,5 cm. 2 poignées inox. H : 110 cm - L : 101 cm - P : 65 cm. Poids : 40 kg.

| Chariot monobloc | 📦 | ● Bleu | ● Framboise | ● Noir | P.U |
|---|---|--------|-------------|--------|----------|
| Spécial petit-déjeuner | 1 | 201317 | 203533 | 203534 | 1563,74€ |
| Accessoires | 📦 | | | | P.U |
| Option support inox pour 1 bac GN1/1 | 1 | 201718 | | | 105,15€ |
| Option support inox pour 3 bacs GN1/3 | 1 | 201720 | | | 105,15€ |
| Lot de 3 bacs GN1/3 avec couvercle - H 15 cm | 1 | 201721 | | | 125,09€ |
| Option support inox pour 4 bacs GN1/4 | 1 | 201722 | | | 105,15€ |
| Lot de 4 bacs GN1/4 avec couvercle - H 15 cm | 1 | 201723 | | | 142,00€ |
| Échelle inox pour 2 supports bacs | 1 | 201724 | | | 185,19€ |
| Tiroir inox pour 2 bacs GN 1/4 | 1 | 201727 | | | 59,83€ |
| Support poubelle inox avec poubelle 25 litres | 1 | 201729 | | | 94,39€ |
| Tablette de préparation | 1 | 203535 | | | 50,32€ |



"Nous consulter"

Chariot double gastro 14 niveaux
Structure tube inox carré 25 mm
18/10. Plateau inox 15/10 insonorisé
avec mousse. Alvéolit alimentaire.
Espaces entre glissières : 98 mm.
Roues composite sans frein Ø125mm.

4 portes - 81 x 61 x H 102 cm 1 206811 1895,95€



Chariot petit-déjeuner gastronomique 2 compartiments

7 glissières - 14 plateaux 53 x 32,5 cm ou 28 plateaux 26,5 x 32,5 cm
Espace entre glissières : 9,8 cm

810 x 610 x H 1020 mm 1 201315 1256,65€



Chariot petit-déjeuner

Inox, GN1/1 avec tablette supérieure et galerie anti-chute. Poignée.
2 x 7 niveaux, entrée 32,5 cm. 4 roues pivotantes à chape polyamide
dont 2 à frein

85 x 64 x H 102 cm 1 203681 618,80€

Chariot petit-déjeuner gastronomique 3 compartiments

Structure tube inox carré 2,5 cm Plateau
inox 15/10e insonorisé avec mousse Alvéolit
alimentaire. Roues composite sans frein
Ø 12,5 cm. Capacité de
stockage : 21 plateaux
53 x 32,5 cm ou 42
plateaux 26,5 x 32,5
cm. Espace entre
glissières : 9,8 cm -
Profondeur : 61 cm.

H 99 cm x L 117 cm 1 201316 1701,64€



CONTENEUR ISOTHERME



Système modulaire  P.U

1 porte active analogique
1 AF12 neutre, un socle rouleur et un système de fixation

1 **206946** 1907,81€



Conteneur double
1 porte active + 1 porte neutre. Pour 12 bacs GN 1/1. Profondeur : 6,5 cm. Couleur bleu ardoise

 P.U

1 **203063** 2423,71€



Conteneur chaud et froid

1 compartiment chaud actif (en haut),
1 compartiment froid actif (en bas).

PCU 1000  P.U

1 **205724** 8819,93€



Conteneur isotherme AF7  P.U

Avec porte chauffante analogique

1 **206819** 782,57€



Conteneur isotherme
Porte chauffante, pour 6 bacs GN 1/1 profondeur 6,5 cm. Couleur bleu ardoise.

 P.U

1 **203059** 1293,00€



Conteneur isotherme
Coque polyéthylène, pour 4 bacs GN 1/1 - H 10 cm et pour 6 bacs GN 1/1 - H 6,5 cm. 12 glissières.

 P.U

Gris 1 **203014** 433,84€

Bleu 1 **203013** 433,84€

Jeu de roulettes  P.U

Pour réf. 203013 et 203014 1 **203183** 179,10€



Chariot de transport en polyéthylène  P.U

Pour conteneur AF12

1 **206820** 242,66€



Socle robuste  Noir P.U

53 x 70 x 23 cm 1 **205722** 361,97€

Repas

Conteneur isotherme XXL
12 glissières Gastronorme, fermeture en matériel antichoc. Optimisé pour le système modulaire. Poignées en acier inox. Porte-étiquette intégrée. Évent réglable. Joint démontable. Option porte active. Pour 4 bacs GN 1/1. Profondeur 10 cm.



44 x 66,5 x 65 cm, L. 90 1 **201235** **401,13€**



Conteneur à nourriture P.U.
4L 1 **205728** **322,00€**
6L 1 **205729** **350,00€**
10L 1 **205730** **406,00€**



Conteneur à soupe P.U.
42 x 23 x 47 cm, 12,7 L 1 **200808** **240,12€**



Conteneur isotherme
7 glissières, 63 L. Pour 2 GN 1/1. Profondeur 15 cm

44 x 64 x 48 cm 1 **260117** **266,80€**



Conteneur isotherme P.U.
5,5 L - 29 x 26,5 x 44 cm 1 **205725** **221,32€**



Conteneur isotherme Liquides thermax QC10 P.U.
Pour liquides, avec robinet, 10 litres en couleur mélange gris/bleu 254 1 **206947** **207,95€**



Conteneur isotherme GN 1/1 Profondeur 20 cm P.U.
41,5 x 66 x 30 cm, L. 39 1 **261139** **242,09€**

SHERPA



Sherpa F3 - 82 L Ouverture frontale pour 4 GN 1/1. Profondeur 6,5 cm P.U.
47,8 x 68,3 x 53,4 cm 1 **203158** **590,86€**



Sherpa L5 avec robinet 5 L, pour liquides chauds ou froids. Bac inox amovible + couvercle inox étanche. P.U.
27,1 x 44 x 37 cm 1 **203160** **445,92€**



Sherpa F4 - 63 L Ouverture frontale pour 6 GN 1/1. Profondeur 6,5 cm P.U.
47,8 x 68,3 x 63,2 cm 1 **203159** **625,62€**

Sherpa F2 - 44 L Ouverture frontale pour 3 GN 1/1. Profondeur 6,5 cm P.U.
47,8 x 69,5 x 37,8 cm 1 **206812** **360,14€**

Sherpa L10 Sans robinet P.U.
28,4 x 49 x 43 cm - 10 L 1 **203161** **434,83€**

DISTRIBUTION

Repas

CAM GOBOX GAMME D'UNITÉS DE TRANSPORT ISOLANTES

Moyen de transport ultra-léger, offrant une meilleure conservation de la température et donc une meilleure protection des aliments,

- Isolation thermique - Maintien au chaud et au froid pendant des heures, de -40°C à 120°C.
- Léger - En polypropylène expansé (EPP) - matériau écologique à base de mousse haute performance.
- Grande solidité structurelle - capable de transporter d'importantes charges tout en conservant sa forme.
- Excellente absorption calorifique - peut résister à des chocs thermiques importants sans dommage.
- Lavable en lave-vaisselle.
- Sans CFC.
- 100% recyclable.



Conteneur isotherme EPP à chargement frontal

64,5 x 44 x 47,5 cm, 60 L, pour 4 GN1/1 profondeur 6,5 cm

1 **201494** **184,47€**

64,5 x 44 x 63 cm, 86 L, pour 6 GN1/1 profondeur 6,5 cm

1 **201495** **219,47€**

Conteneur isotherme en PPE à chargement frontal

9 niveaux, pour bacs GN 1/1 - Version économique avec charnières en plastique

1 **204521** **152,31€**

12 niveaux, pour bacs GN 1/1 - Version haute gamme avec charnières en inox

1 **204520** **152,31€**



Conteneur isotherme EPP à chargement par le haut

64,5 x 44 x 47,5 cm, 35 L, pour 3 GN1/1 profondeur 6,5 cm

1 **201489** **35,51€**

Conteneur isotherme EPP à chargement par le haut

53 L - 69 x 49 x 27 cm pour bac 60 x 40 profondeur 20 cm

1 **205731** **42,68€**

80 L - 69 x 49 x 37 cm pour bac 60 x 40 profondeur 30 cm

1 **205732** **48,27€**

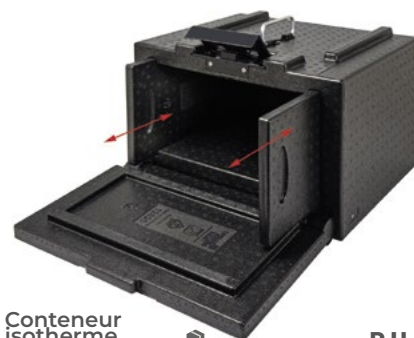

Conteneur isotherme pizza carry

À ouverture frontale, pour la livraison à domicile - 43 x 47 x 33 cm

1 **204535** **53,90€**



Chariot pour conteneurs GN 1/1

Gamme EPP 1 **201731** **76,50€**



Socle rouleur

60 x 40 cm 1 **205733** **107,03€**



Socle mobile

Sans poignée 1 **205726** **337,72€**

Avec poignée 1 **205727** **389,13€**



Conteneur EPP à chargement frontal multifonction

Sans glissières 61,5 x 41 x 58,5 cm - 155L

1 **206813** **218,95€**

Avec 2 glissières réglables 61,5 x 41 x 58,5 cm - 155L

1 **206814** **354,89€**



Plateau chauffant léger Cam GoHeat
Chargement par le haut et à chargement frontal. Chauffe à 75° C.

Adaptée aux poêles GN 1/1 1 **206815** **255,20€**



Séparateur ThermoBarrier®

Pour EPP 300/400 1 **206816** **19,50€**

DISTRIBUTION

Repas



| Conteneur isotherme 600 x 400 | Q | P.U |
|-------------------------------|---|---------------|
| H. 260 / 200 mm - 53 L | 1 | 206818 43,89€ |
| H. 360 / 300 mm - 80 L | 1 | 206817 48,51€ |



| Conteneur isotherme pour bacs GN 1/2 | Q | P.U |
|--------------------------------------|---|---------------|
| Hauteur utile 11,7 cm | 1 | 204529 28,07€ |
| Hauteur utile 16,7 cm | 1 | 204530 30,00€ |
| Hauteur utile 21,7 cm | 1 | 204531 30,77€ |
| Hauteur utile 25,7 cm | 1 | 204532 33,07€ |



| Conteneur isotherme pour bacs GN 1/1 | Q | P.U |
|---|---|---------------|
| Hauteur utile 11,7 cm | 1 | 204522 33,84€ |
| Hauteur utile 16,7 cm | 1 | 204523 35,38€ |
| Hauteur utile 21,7 cm | 1 | 204524 36,15€ |
| Hauteur utile 25,7 cm | 1 | 204525 37,69€ |
| Hauteur utile 33,7 cm | 1 | 204526 64,56€ |
| Version économique, hauteur utile 23 cm | 1 | 204527 26,92€ |
| Version confort, hauteur utile 29,5 cm | 1 | 204528 60,76€ |



| Shopping box | Q | P.U |
|-------------------------|---|----------------|
| Pour bacs GN 1/4 - 20 L | 1 | 204533 37,69 € |
| Pour bacs GN 1/2 - 33 L | 1 | 204534 43,84 € |

Conteneur isotherme Dinner Box
Pour plats rectangulaires ou assiettes rondes et bols.



| Conteneur isotherme Dinner Box | Q | P.U |
|--|---|---------------|
| 3 emplacements vides - 440 x 370 x 120 | 1 | 204536 63,56€ |
| 4 emplacements vides - 530 x 370 x 120 | 1 | 204537 69,57€ |

TABLOTHERM CAM GOBOX™
Plateau repas isotherme
1 assiette 23 cm à deux compartiments avec couvercle,
2 bols ronds avec couvercles.
Tablotherm Cam Gobox™



| Tablotherm Cam Gobox™ | Q | P.U |
|-----------------------|---|----------------|
| 37 x 53 x 11,8 cm | 1 | 205741 102,40€ |



| Plaques eutectiques | Q | Surgelée | P.U | Fraîche | P.U | Froide | P.U | Chaude | P.U |
|---------------------|---|----------|--------|---------|--------|--------|--------|--------|--------|
| Melform | 1 | 260011 | 42,76€ | 260116 | 69,57€ | | | | |
| Bourgeat | 1 | | | 201334 | 69,57€ | | | | |
| Cambro | 1 | | | | | 201732 | 63,56€ | 201733 | 69,57€ |
| Thermo Future Box | 1 | | | | | 204538 | 63,56€ | 204539 | 69,57€ |



| Assiettes rondes | Q | P.U |
|----------------------------------|---|---------------|
| 1/1 - Ø 25,5 cm x H 4,3 cm | 1 | 205735 25,38€ |
| 2/3 - 1/3 - Ø 25,5 cm x H 4,3 cm | 1 | 205734 25,38€ |
| 3/3 - Ø 25,5 cm x H 4,3 cm | 1 | 205271 25,38€ |



| Couvercles silicone | Q | Bleu | Rouge | P.U |
|---------------------|---|--------|--------|--------|
| Pour assiette ronde | 1 | 205273 | 205274 | 18,07€ |
| Pour bol | 1 | 205275 | 205276 | 6,07€ |

| Bol | Q | P.U |
|-----------------------------|---|--------------|
| 300 ml - Ø 11,5 cm x H 6 cm | 1 | 205272 7,30€ |

En raison d'importantes fluctuations tarifaires, les prix indiqués (hors DROM-COM) sont à titres indicatifs et peuvent évoluer. Merci de vous rapprocher de votre Distributeur/Installateur. Prix de vente conseillé.

VENTE À EMPORTER, USAGE UNIQUE

Films, Sacs sous vide



Film aluminium
En boîte distributrice. **P.U**
Avec lame de scie.

| | | | |
|-----------------|---|--------|--------|
| 200 m x 29,5 cm | 6 | 282488 | 14,63€ |
| 200 m x 44 cm | 6 | 282489 | 21,49€ |



Film alimentaire
En boîte distributrice. **P.U**

| | | | |
|-----------------|---|--------|-------|
| 300 m x 30 cm | 6 | 282490 | 6,37€ |
| 300 m x 45 cm | 6 | 282491 | 8,82€ |
| 30 cm - zip cut | 6 | 204546 | 6,46€ |
| 45 cm - zip cut | 6 | 204547 | 9,17€ |



Sac de conservation
sous vide **P.U**

| | | | |
|-------------------|---|--------|--------|
| 25 x 35 - par 100 | 6 | 201111 | 35,72€ |
| 28 x 40 - par 25 | 6 | 201112 | 11,17€ |



Recharge
aluminium **P.U**

| | | | |
|-----------------------------------|---|--------|--------|
| 200 m x 29,5 cm - sous embouts | 3 | 204541 | 42,82€ |
| 200 m x 32,5 cm - sous embouts | 3 | 204543 | 47,07€ |
| 200 m x 44 cm - sous embouts | 3 | 204545 | 63,62€ |



Recharge film
étirable **P.U**

| | | | |
|---------------|---|--------|--------|
| 300 m x 30 cm | 4 | 204548 | 5,58€ |
| 300 m x 45 cm | 4 | 204549 | 8,08€ |
| 300 m x 60 cm | 3 | 204550 | 12,06€ |



Dérouleur plastique
universel
Alu/Film **P.U**

| | | | |
|----------|---|--------|--------|
| 30-45 cm | 1 | 204557 | 58,64€ |
|----------|---|--------|--------|



Sac sous vide lisse
Pour la conservation **P.U**

| | | | |
|---------------------------|---|--------|--------|
| 250 x 400 mm - par 100 | 1 | 201500 | 13,73€ |
| 300 x 400 mm - par 100 | 1 | 201501 | 16,41€ |
| 350 x 230 mm - par 100 | 1 | 201499 | 11,05€ |
| 150 x 280 mm - par 100 | 1 | 201497 | 5,73€ |
| 200 x 300 mm - par 100 | 1 | 201498 | 8,20€ |
| 300 x 500 mm - par 100 | 1 | 201496 | 20,46€ |



Dérouleur pour film
et alu
Inox **P.U**

| | | | |
|-------|---|--------|---------|
| 30 cm | 6 | 201051 | 101,21€ |
| 45 cm | 6 | 201052 | 112,41€ |



Réglette coupe-film **P.U**

| | | | |
|-------|---|--------|--------|
| 30 cm | 6 | 201053 | 11,62€ |
| 45 cm | 6 | 201054 | 17,54€ |

VENTE À EMPORTER, USAGE UNIQUE

Barquettes



| Barquette translucide PP scellable micro-ondable | | | P.U |
|--|---|--------|---------|
| 250 g - (24 x 100) | 1 | 272500 | 102,05€ |
| 375 g - (18 x 120) | 1 | 272501 | 109,62€ |
| 480 g - (16 x 100) | 1 | 272502 | 107,87€ |
| 730 g - (9 x 140) | 1 | 272503 | 113,35€ |
| 1 015 g - (6 x 160) | 1 | 204019 | 117,81€ |
| 1 800 g - (6 x 100) | 1 | 204021 | 88,79€ |
| 1 440 g - (6 x 110) | 1 | 204106 | 87,43€ |

| Couvercle barquette Pour 250 à 500g | | | P.U |
|-------------------------------------|---|--------|--------|
| 14,2 x 10,1 x 1,2 cm - (18 x 50) | 1 | 272510 | 82,31€ |



| Couvercle barquette Pour 750 à 2000g | | | P.U |
|--------------------------------------|---|--------|---------|
| 19,7 x 14,2 x 1,2 cm - (16 x 50) | 1 | 272511 | 125,55€ |



| Barquette charcutière translucide PS | | | P.U |
|--------------------------------------|---|--------|---------|
| 125 g - (10 x 500) | 1 | 272012 | 90,48€ |
| 250 g - (6 x 500) | 1 | 272025 | 86,97€ |
| 375 g - (10 x 250) | 1 | 272037 | 93,64€ |
| 500 g - (6 x 250) | 1 | 272050 | 74,75€ |
| 750 g - (5 x 250) | 1 | 272075 | 88,76€ |
| 1 000 g - (4 x 250) | 1 | 272100 | 112,39€ |



| Barquette cristal APET À couvercle rentrant | | | P.U |
|---|---|--------|--------|
| 250 g - (18 x 50) | 1 | 201041 | 74,75€ |
| 370 g - (12 x 50) | 1 | 201042 | 52,95€ |
| 500 g - (12 x 50) | 1 | 201043 | 65,66€ |
| 750 g - (8 x 50) | 1 | 201044 | 61,94€ |
| 1 000 g - (7 x 50) | 1 | 201045 | 61,44€ |
| 1 500 g - (12 x 15) | 1 | 201046 | 42,48€ |
| 2 000 g - (12 x 15) | 1 | 201047 | 50,81€ |

VENTE À EMPORTER, USAGE UNIQUE

Barquettes



Gastronorm Aluminium  P.U

3000 ml H : 5 cm - par 100 1 **204169** **53,19€**

Gastronorm Aluminium  P.U

5350 ml - H : 4 cm - par 100 1 **204170** **199,00€**

Gastronorm Aluminium  P.U

8850 ml - H : 7 cm - par 100 1 **204171** **232,60€**



Barquettes rectangulaires Aluminium  P.U

450 ml - par 100 1 **200401** **10,55€**
 550 ml - par 100 1 **204173** **12,26€**
 900 ml - par 100 1 **204174** **17,70€**
 910 ml - par 100 1 **204175** **19,71€**
 1100 ml - par 100 1 **204176** **22,72€**



Couvercles  P.U

14 x 11,4 cm - par 100 1 **200402** **4,39€**
 18,5 x 13,4 cm - par 100 1 **204178** **7,03€**
 21,2 x 14,9 cm - par 100 1 **204180** **8,58€**
 21,2 x 10,7 cm - par 100 1 **200404** **5,82€**
 21,9 x 16,9 cm - par 100 1 **204181** **9,75€**

VENTE À EMPORTER, USAGE UNIQUE

Récipients



| Barquettes Aluminium | ◆ | P.U |
|----------------------------------|---|-----------------------|
| 450 g - Haut. : 41 mm - (10x100) | 1 | 204227 175,53€ |
| 500 g - Haut. : 49 mm - (10x100) | 1 | 204228 193,59€ |
| 850 g - Haut. : 48 mm - (10x100) | 1 | 204229 278,34€ |
| 950 g - Haut. : 41 mm - (10x100) | 1 | 204230 289,78€ |
| 1060 g - Haut. : 46 mm - (4x100) | 1 | 204231 127,63€ |
| 1500 g - Haut. : 70 mm - (6x100) | 1 | 204232 247,51€ |
| 1850 g - Haut. : 52 mm - (4x100) | 1 | 204233 160,65€ |
| 2000 g - Haut. : 56 mm - (4x100) | 1 | 204234 189,03€ |

| Couvercles Aluminium | ◆ | P.U |
|--|---|-----------------------|
| Couvercle pour 320 g / 450 g / 500 g - (20x50) | 1 | 204235 66,53€ |
| Couvercle pour 850 g - (10x100) | 1 | 204236 134,16€ |
| Couvercle pour 950 g - (10x100) | 1 | 204237 146,73€ |
| Couvercle pour 1500 g - (16x50) | 1 | 204238 106,80€ |
| Couvercle pour 1 060 g - (20x50) | 1 | 204239 145,15€ |
| Couvercle pour 1 850 g - 2000 - (4x100) | 1 | 204240 70,48€ |



VENTE À EMPORTER, USAGE UNIQUE

Récipients



Pasta box
Récipients
multiusages

| | | P.U |
|--------------------------------|----------|--------|
| 480 ml - Ø 8x9 cm - par 100 | 1 203669 | 15,36€ |
| 960 ml - Ø 9x10,8 cm - par 100 | 1 203671 | 25,19€ |



Boîte à pizza

| | | |
|---------------------------------|----------|--------|
| 33 x 33 cm - H 3,5 cm - par 100 | 1 204076 | 33,52€ |
|---------------------------------|----------|--------|



Boîtes hamburger
Carton ondulé nano-
micro

| | | |
|----------|----------|---------|
| Par 1000 | 1 202777 | 235,74€ |
| Par 1000 | 1 202778 | 164,34€ |



Sachets sandwich "Feel Green"

| | | |
|--------------------------|----------|--------|
| 9 x 4 x 30 cm - par 1000 | 1 205787 | 23,31€ |
|--------------------------|----------|--------|



Pots à soupe avec
couverture

| | | P.U |
|--|----------|--------|
| 360 ml - Ø 9 - 7,3 x 8,6 cm - par 100 | 1 202775 | 23,81€ |
| 480 ml - Ø 9,8 - 7,5 x 10 cm - par 100 | 1 202776 | 26,24€ |



Gobelets à frites
avec fermeture

| | | |
|-------------------------------|----------|---------|
| 480 ml - 8,5x14 cm - par 1000 | 1 205788 | 134,13€ |
|-------------------------------|----------|---------|



Boîte hermétique
avec couvercles
Lot de 12

| | | |
|------------------------------|----------|--------|
| 0,6 L - 11 x 11 x H 7,5 cm | 1 206821 | 34,16€ |
| 1,2 L - 21,5 x 11 x H 7,5 cm | 1 206822 | 56,99€ |

Boîte hermétique
avec couvercles
Lot de 6

| | | |
|----------------------------|----------|--------|
| 2,5 L - 22 x 22 x H 7,5 cm | 1 206823 | 51,29€ |
|----------------------------|----------|--------|



VENTE À EMPORTER, USAGE UNIQUE

Récipients



| Saladiers | | Kraft | P.U |
|---------------------------------------|---|--------|--------|
| Ø 15/12,8 x 4,5 cm - 500 ml - par 100 | 1 | 202783 | 16,07€ |
| Ø 15/12,8 x 6 cm - 750 ml - par 100 | 1 | 202784 | 16,45€ |
| Ø 15/12,9 x 8 cm - 1000 ml - par 100 | 1 | 202785 | 17,03€ |



| Couvercles pour saladiers 500 / 750 / 1000 ml | | Transparent | P.U |
|---|---|-------------|--------|
| Ø 15 cm - par 100 | 1 | 202786 | 11,97€ |
| Ø 15 cm - par 100 - (adapté au micro-ondes) | 1 | 202787 | 12,89€ |



| Saladiers | | Kraft | P.U |
|--|---|--------|--------|
| Ø 18,4/16 x 6,6 cm - 1300 ml - par 100 | 1 | 202788 | 23,98€ |



| Couvercles pour saladiers 1300 ml | | Transparent | P.U |
|---|---|-------------|--------|
| Ø 18,4 cm - par 100 | 1 | 202789 | 15,32€ |
| Ø 18,4 cm - par 100 (adapté au micro-ondes) | 1 | 202790 | 17,03€ |



| Barquettes | | Blanc | P.U |
|---------------------------------------|---|--------|--------|
| 710 ml - 21,5 x 14 x 3,7 cm - par 100 | 1 | 202781 | 13,48€ |
| 950 ml - 21,5 x 14 x 5,2 cm - par 100 | 1 | 202780 | 15,40€ |



| Couvercle bas pour barquettes | | Transparent | P.U |
|-------------------------------|---|-------------|--------|
| 22 x 14,6 x 0,9 cm - par 100 | 1 | 202782 | 16,32€ |



VENTE À EMPORTER, USAGE UNIQUE

Couverts, Assiettes

SOMMAIRE | INDEX

ISAP

GARCIA DEPOU

iO2



| Georgette biodégradable | Crème | Blanc fibres végétales | Noir | P.U | |
|-------------------------|-------|------------------------|--------|--------|---------|
| 16 cm - par 200 | 1 | 204562 | 204563 | 204564 | 105,84€ |



| Pochette serviettes kangourou DRY COTTON | Chocolat | Graphite | P.U | |
|--|----------|----------|--------|---------|
| 40 x 40 cm - par 1000 | 1 | 102615 | 102616 | 119,65€ |

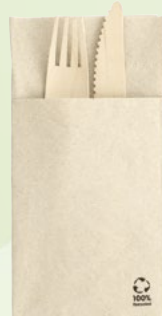

Matériel 100% recyclé

| Pochette serviettes kangourou ECOLABEL Matériel 100% recyclé | P.U |
|--|-----------------|
| 40 x 40 cm 2 plis - par 1000 | 1 102611 35,49€ |

FEEL'GREEN

VAISSELLE EN FEUILLE DE PALME



| Assiette en feuille de palme | P.U |
|-----------------------------------|-----------------|
| Ø 18 x 2 cm - Plate - par 100 | 1 102630 31,60€ |
| Ø 23 x 2 cm - Plate - par 100 | 1 102631 39,00€ |
| Ø 12,5 x 2 cm - Creuse - par 100 | 1 102629 25,86€ |
| Ø 18 x 3,5 cm - Creuse - par 100 | 1 102628 35,78€ |
| 20 x 20 x 4 cm - Creuse - par 100 | 1 102632 41,22€ |



| Assiette en carton | Blanc | P.U |
|--------------------|-------|---------------|
| Ø 18 cm (10x100) | 1 | 203667 33,70€ |
| Ø 23 cm (10x100) | 1 | 203668 52,61€ |



VENTE À EMPORTER, USAGE UNIQUE

Serviettes, Sacs, Pailles, Cure-dents, Piques



Set de table papier **P.U**
 Ø 31 x 43 cm - 48 g/m² - par 1000 1 **102623 22,77€**



Set de table papier «Times» **P.U**
 Ø 31 x 43 cm - 48 g/m² - par 1000 1 **102624 28,04€**



Serviettes recyclées **P.U**
 39 x 39 cm - par 1000 1 **102613 27,45€**
 20 x 20 cm - par 1000 1 **102614 10,17€**



Serviettes "Eco-Bamboo" **P.U**
 40 x 40 cm - par 1000 - Fibre bambou 1/4 1 **102621 198,37€**

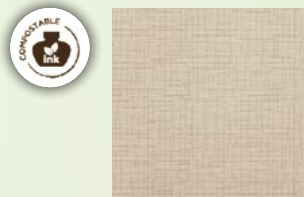

Serviettes "Dry Cotton" **P.U**
 40 x 40 cm - par 1000 1 **102617 114,96€**

Chocolat Graphite **P.U**
 1 **102618 114,96€**

Serviettes "Like Linen" **P.U**
 40 x 40 cm - par 1000 1 **102619 160,66€**
 20 x 20 cm - par 1000 1 **102620 60,72€**

Chocolat **P.U**
 1 **102620 60,72€**



Pailles droites **P.U**
 Ø 0,60 x 20 cm - par 100 1 **202796 1,46€** Naturel Kraft **202797 1,46€** Noir **202798 1,46€** Blanc



Sac kraft poignées ficelle **P.U**
 20 + 10 x 29 cm - par 1000 1 **201516 133,75€**
 26 + 14 x 32 cm - par 1000 1 **201517 159,49€**



Piques brochette **P.U**
 15 cm - par 1000 1 **205789 5,61€** Naturel bois



Sacs cabas en plastique bioplast **P.U**
 30 x 54 cm - Soufflet de 7 cm - épaisseur 16 M - Carton de 1000 (10 sachets de 100) 1 **206038 124,71€**
 26 x 54 cm - Soufflet de 6 cm - épaisseur 13 M - Carton de 1000 (10 sachets de 100) 1 **206039 66,35€**



Cure-dents ronds **P.U**
 H 6,8 cm - par 1000 1 **100870 1,05€**
 H 6,8 cm - par 1000 - Tournés 1 pointe 1 **206824 1,05€**



Piques "Ruban" **P.U**
 6 cm - par 100 1 **206825 1,59€**
 9 cm - par 100 1 **206826 1,72€**

Piques "Golf" **P.U**
 9 cm - par 100 1 **206827 1,17€**
 15 cm - par 100 1 **206828 1,59€**

HYGIÈNE

Étiquettes



Labelfresh dispenser **P.U**
Inox 1 **202585 59,61€**



Labelfresh Starterkit Pro **P.U**
7 x 500 1 **202601 129,26€**
70 x 45 mm



Labelfresh Starterkit Easy **P.U**
7 x 1000 1 **202600 121,72€**
30 x 25 mm



Labelfresh Easy x 1000 **P.U**
30 x 25 mm - LUNDI 6 **202586 7,15€**
30 x 25 mm - MARDI 6 **202587 7,15€**
30 x 25 mm - MERCREDI 6 **202588 7,15€**
30 x 25 mm - JEUDI 6 **202589 7,15€**
30 x 25 mm - VENDREDI 6 **202590 7,15€**
30 x 25 mm - SAMEDI 6 **202591 7,15€**
30 x 25 mm - DIMANCHE 6 **202592 7,15€**



Labelfresh Pro x 500 **P.U**
70 x 45 mm - LUNDI 6 **202593 8,88€**
70 x 45 mm - MARDI 6 **202594 8,88€**
70 x 45 mm - MERCREDI 6 **202595 8,88€**
70 x 45 mm - JEUDI 6 **202596 8,88€**
70 x 45 mm - VENDREDI 6 **202597 8,88€**
70 x 45 mm - SAMEDI 6 **202598 8,88€**
70 x 45 mm - DIMANCHE 6 **202599 8,88€**



Labelfresh Warning **P.U**
x 500 6 **202603 9,20€**
70 x 45 mm - surgelés 6 **202603 9,20€**
70 x 45 mm - 14 allergènes - incl. Pictos 6 **202604 9,04€**



Etiquettes hydrosolubles **P.U**
Boîte de 220 - 85 x 32 mm 1 **206829 27,41€**
Boîte de 350 - 85 x 32 mm 1 **206830 14,54€**

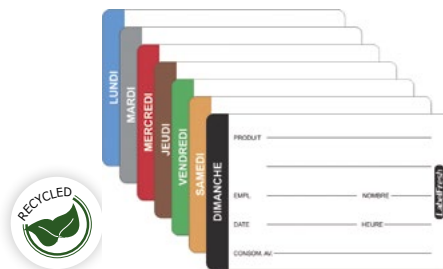

Labelfresh Warning biodégradable x 250 **P.U**
30 x 50 mm 6 **202607 11,86€**
70 x 45 mm 6 **202606 14,91€**



Labelfresh Express **P.U**
Easy 7 x 250 12 **202602 56,23€**
30 x 25 mm

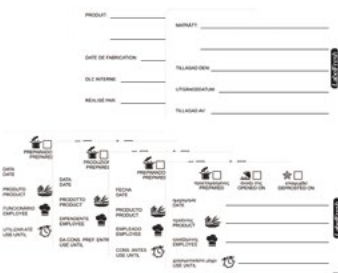

Labelfresh Warning **P.U**
x 300 6 **202605 8,87€**
70 x 45 mm - dlc



Labelfresh mini dispenser **P.U**
Inox 1 **202584 22,43€**



Etiquettes de rotation solubles **P.U**
24 Rouleaux de 250 1 **205743 754,77€**

Testeur et filtre à huile



Testeur d'huile de friture re-étalonnable

+50+250°C

10 **206832** **310,96€**

P.U



Testeur d'huile à usage unique

En boîte de 10 tests. Livré avec pipette, support anti-brûlure.

10 **203490** **36,08€**

P.U



Filtre à huile micro filtre

Permet de prolonger de 50% la durée d'utilisation d'huile. Toile synthétique micro-filtre pour filtration de tous les résidus. Température huile max. lors du filtrage : 115°C. Nettoyage : eau chaude sans détergent.

Filtre complet monture métallique, L totale 530 mm

1 **229549** **182,78€**

P.U

Filtre de rechange, L 300 x l 200 mm

1 **229550** **127,56€**



HYGIÈNE

Thermomètres, enregistreur



Thermomètre frigo
Gaine en polypropylène blanche. Crochet spécial breveté pour le réglage de la hauteur. **P.U.**

-50 à +50°C 10 **266002** **7,88€**



Thermomètre charcutier
Gaine en polypropylène blanche. Crochet spécial breveté pour le réglage de la hauteur. **P.U.**

-10 à +120°C 10 **266004** **8,75€**



Thermomètre frigo/congélateur
Gaine en polypropylène blanche. Crochet spécial breveté pour le réglage de la hauteur. **P.U.**

-40 à +30°C 1 **204577** **11,94€**



Thermomètre confiseur
Gaine en en polyamide grise. Crochet spécial breveté pour le réglage de la hauteur. **P.U.**

+80 à +200°C 10 **200475** **11,39€**



Thermomètre confiseur
Gaine inox **P.U.**

+80 à +200°C 10 **200476** **23,60€**



Thermomètre digital multi usage
Protection : IP 65 Sonde inox perçante: 100 mm - Ø 3,8 mm - 2,5mm avant la pointe
Compatible induction **P.U.**

-50 +300°C 10 **205744** **25,60€**



Thermomètre digital frigo/congélateur
2 alarmes programmables (clignotante et sonore) Câble IP67 : 100 cm - avec ventouse **P.U.**

-50 +70°C 10 **205745** **38,48€**

Thermomètre digital cuisson et four
Alarmes programmables (clignotante et sonore) Câble : inox 100 cm - complètement étanche IP67 Sonde : 150 mm - Ø4 mm avec renforcement spécial - étanche IP67 en Inox pour contact alimentaire Compatible induction **P.U.**

Thermomètre digital cuisson et four **P.U.**

-50 +300°C 10 **205746** **43,28€**



Thermomètre plastique vertical
Pour frigo/congélateur **P.U.**

-50+50°C : 1°C 1 **266001** **1,95€**



Minuteur digital "goutte d'eau" **P.U.**

Minuteur / Chronomètre / Horloge 1 **206833** **20,19€**



Thermomètre Digital Cuisson stylo de poche **P.U.**

-50+300°C 1 **206834** **7,04€**

Enregistreur de température
Étanche IP65. Capteur interne + Sonde externe. **P.U.**

-40+85°C 1 **201997** **72,34€**



Lingettes
Usage unique. Nettoyage sans rinçage des surface en contact avec les aliments. **P.U.**

Boîte de 100. 1 **200809** **11,82€**



Pèse sirop **P.U.**

Double échelle 1100-1400 g/ml et 15-40° Bé - ±125 mm 1 **205790** **5,41€**

LAVERIE



CENTRALE 1P DC
Centrale de désinfection 1 produit. Tuyau alimentaire 15 m, pistolet antichoc, support mural.

| CENTRALE 1P DC | | P.U |
|----------------|---|----------------|
| Pour bidon 5 L | 1 | 206836 265,00€ |

ENTRETIEN SURFACE



| PLONGE 100 | | P.U |
|---------------------------|---|---------------|
| Détergent plonge manuelle | | |
| Carton de 4 x 5 L | 1 | 203047 24,99€ |

| LM 660 - LM 560 | | P.U |
|---|---|---------------|
| Liquide de lavage vaisselle en machine en carton de 4 x 5 L | | |
| Lavage eau dure - LM 660 | 1 | 203031 43,56€ |
| Lavage eau douce - LM 560 | 1 | 203030 28,90€ |

| LAVE LS + | | P.U |
|--|---|---------------|
| Liquide de lavage pour vaisselle et verrerie | | |
| Carton de 4 x 5 L | 1 | 203032 37,18€ |

| PRO FOUR | | P.U |
|--|---|---------------|
| Liquide dégraissant pour matériel de cuisson | | |
| Carton de 4 x 5 L | 1 | 203046 44,00€ |

| LAVE CHLORE 755 | | P.U |
|--|---|---------------|
| Liquide de lavage de la vaisselle chloré | | |
| Bidon de 20 L | 1 | 203054 47,80€ |

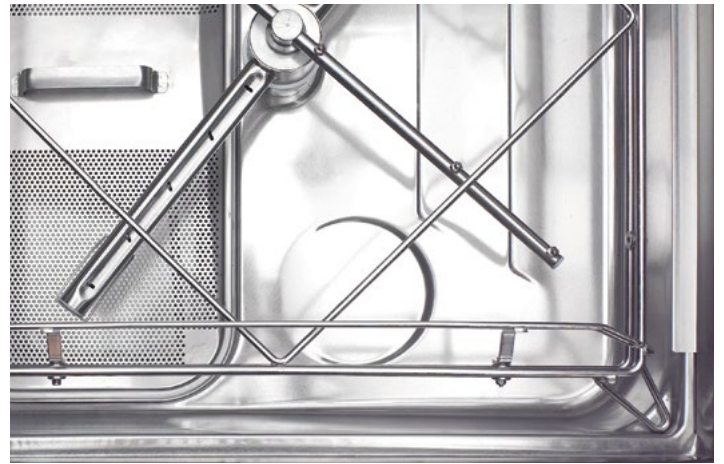

| PRO BRILL INOX | | P.U |
|---------------------------|---|---------------|
| Nettoyant toutes surfaces | | |
| Carton de 12 x 500 ml | 1 | 203051 58,70€ |



| NETTAL 2D2 | | P.U |
|---|---|---------------|
| Détergent désinfectant homologué bactéricide, fongicide | | |
| Carton de 4 x 5 L | 1 | 203044 50,01€ |

SERVICES TECHNIQUES



| PRO VITRES | | P.U |
|------------------------------------|---|---------------|
| Liquide de nettoyage des vitres PE | | |
| Carton de 12 x 500 ml | 1 | 204584 26,04€ |

Sèche-mains, Distributeurs pour bobines



Distributeur nouvelle 'Série 7' **P.U.**
Pour rouleaux maxi dévidage central 1 **204242** **52,38€**



Essuie-mains maxi DC Pure cell. blanche **P.U.**
20 x 24 cm - 2 plis - Gaufré collé - 6 rouleaux 1 **201222** **36,45€**



Distributeur nouvelle 'Série 5' **P.U.**
Pour rouleaux mini dévidage central 1 **204243** **48,73€**



Essuie-mains mini DC Pure cell. blanche **P.U.**
20 x 30 cm - 2 plis - Lisse - 12 rouleaux 1 **201221** **37,92€**



Bobine WIPE-TEX **P.U.**
32 x 70 cm - 200 torchons - 1 rouleau 1 **203631** **89,33€**



Bobine ouate d'essuyage pour labo et atelier **P.U.**
Pure cell. blanche
Lot de 2 rouleaux 800f 24 x 25cm - 2 plis - Gaufré collé - 2 bobines 1 **271000** **25,60€**



Support dévidoir pour bobines d'essuyage **P.U.**
Métal laqué blanc
Mural - pour 1 bobine 30 cm 1 **200846** **28,35€**
Sur pieds - pour 1 bobine 35,5 cm 1 **200847** **50,58€**



Distributeur nouvelle 'Série 7' P.U.

Pour essuie-mains pliés enchevêtrés 1 **204580** **57,33€**



Es enchevêtrés pliés en Z - Ecolabel Pure cell. blanche P.U.

22 x 23 cm - 2 plis - Gaufre collé colis 25x150 - 3750 essuie-mains 1 **270003** **50,58€**



Distributeur 'Série 7' ABS blanc P.U.

Pour papier toilette MAXIROL 1 **205795** **56,41€**



Papier toilette MAXIROL Ecolabel Ouate recyclée blanche P.U.

320 M - 6 rouleaux - 2 plis - Lisse - 6 rouleaux 1 **270300** **39,96€**



Papier toilette MAXIROL Ecolabel Pure cell. blanche P.U.

250 M - 6 rouleaux - 2 plis - Gaufre collé - 6 rouleaux 1 **206948** **32,75€**



Distributeur 'Série 5' P.U.

Pour papier toilette MINIROL 1 **205796** **38,96€**



Papier toilette MINIROL Ecolabel Ouate recyclée blanche P.U.

175 M - 12 rouleaux - 2 plis - Lisse - 12 rouleaux 1 **205747** **39,65€**



Papier toilette MINIROL Ecolabel P.U.

160 M - 12 rouleaux - 2 plis - Gaufre collé - 12 rouleaux 1 **206949** **35,50€**



Sèche-mains intelligent Lampe UV antibactérienne dans le conduit de ventilation et filtre certificat anti-COVID19. Sèche-mains intelligent P.U.

180 x 97 x 280 mm 1 **204579** **176,26€**



Smart sèche-mains à air pulsé avec résistance Capacité : 1.100 W P.U.

221 x 157 x 285 mm 1 **204578** **258,61€**



Distributeur 'Série 7' ABS blanc P.U.

Pour savon liquide - capacité 900ml 1 **204581** **38,20€**

Casier à verres FLAP-RACK

Casier à verres FLAP-RACK

Système de montage facile. Empilable avec d'autres paniers du marché. Renforcé avec une double paroi (anti-choc). Personnalisation facile. Ouvertures pour un nettoyage optimal. Idéal pour le transport et le stockage. Copolymère très résistant aux produits chimiques et aux températures jusqu'à 95 °C. Construction double paroi. Base seule : hauteur maxi des verres inf. à 8 cm. Base + 1 réhausse : hauteur maxi des verres inf. à 12 cm. Base + 2 réhausse : hauteur maxi des verres inf. à 16 cm. Base + 3 réhausse : hauteur maxi des verres inf. à 20 cm. Base + 4 réhausse : hauteur maxi des verres inf. à 24 cm.



9 compartiments

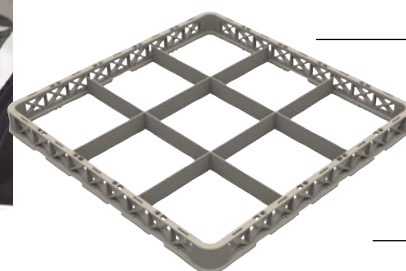

Empilable avec d'autres casiers du marché.

Réhausse uniques démontables 4 cm.

Structure ouverte.

Séparateurs complets base et réhausse, Construction double paroi.

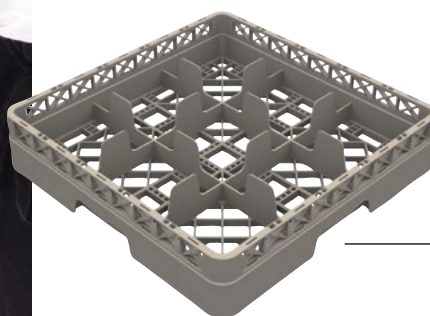

Poignées ergonomiques.

Texture anti-dérapante.

Dimensions standard 50 x 50 cm, hauteur ext, 10 cm, hauteur int, 8,5 cm,

| Casier à verres FLAP-RACK Ø max : des verres : | 9 comp. 15,1 cm | P.U | 16 comp. 11,3 cm | P.U | 25 comp. 8,9 cm | P.U | 36 comp. 7,3 cm | P.U | 49 comp. 6,3 cm | P.U |
|---|--------------------|--------|---------------------|--------|--------------------|--------|--------------------|--------|--------------------|--------|
| Casier à verres H 85 mm | 1 203225 | 15,86€ | 1 203227 | 17,66€ | 1 203229 | 18,41€ | 1 203231 | 19,51€ | 1 203233 | 20,18€ |
| Réhausse H 4 cm | 1 203226 | 7,45€ | 1 203228 | 7,61€ | 1 203230 | 8,07€ | 1 203232 | 8,28€ | 1 203234 | 8,54€ |

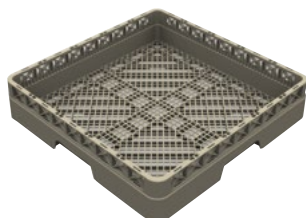

Casier de lavage couverts

P.U

1 250003 17,74€

Couvercle

P.U

50 x 50 cm 1 203235 16,82€

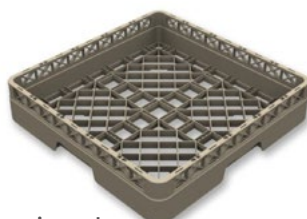

Panier universel En polypropylène

P.U

49 x 49 cm 1 250002 18,24€

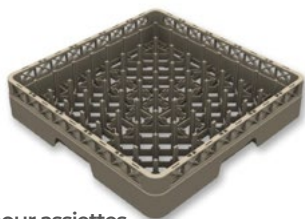

Panier pour assiettes et plateaux En polypropylène

P.U

49 x 49 cm 1 250006 19,31€



Panier pour grands plateaux

P.U

50 x 50 cm 1 250005 35,40€

HYGIÈNE

Casiers de lavage



Panier à couverts
En polypropylène

530 x 325 x H 100 mm 1 **202645** **9,03€**



Panier à couverts antibactérien
En polypropylène

530 x 325 x H 100 mm 1 **202647** **10,59€**

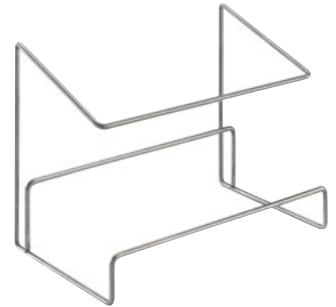

Support panier à couverts

525 x 325 x H 405 mm 1 **202649** **106,19€**

Couvercle
En polypropylène

535 x 330 mm 1 **202646** **6,21€**

Couvercle
En polypropylène

535 x 330 mm 1 **202648** **7,40€**



Godet à couverts Carré

1 compartiment 1 **250001** **1,74€**



Casier à couverts

8 compartiments 1 **250007** **9,75€**



Ramasse-couverts GN 1/1
4 cases

53 x 32,5 x H 10 cm 1 **250013** **9,04€**



Socle rouleur pour casier de lavage
En polymère

Sans poignée 1 **250011** **70,15€**
Avec poignée 1 **250012** **109,08€**



Porte casiers tout inox
Châssis tube 2,5 x 2,5 cm en inox plateau inox amovible épaisseur 12/10e, 4 roues pivotantes diamètre 12,5 cm. Charge maximale 150 kg.

63 x 57 x 90 cm - Avec dossier boulonné et 2 roues à frein 1 **200820** **203,06€**
51,5 x 51,5 x 16,5 cm - Avec dossier boulonné 1 **201063** **169,00€**
60 x 51,5 x 85 cm - Sans dossier boulonné 1 **201064** **200,00€**

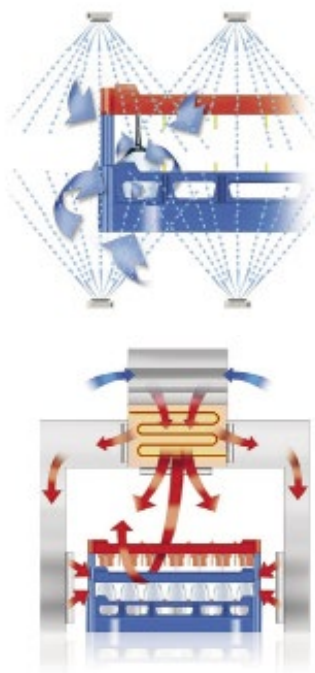

AVANTAGES DES CASIERS FRIES RACK :

- Meilleur résultat de lavage et économie d'eau grâce au design ajouré et au système breveté EWD (*orientation des jets de lavage*)
- Légers, ergonomiques, robustes, manipulation aisée
- Fond duplex pour une meilleure stabilité et accessibilité à l'eau ; compatible avec tous les lave-vaisselle à avancement automatique
- Nombreuses solutions selon les objets à laver (*assiettes, bac gastro, plateaux, verres, tasses, pichets, etc.*)
- Large choix de formats : 500 x 500 / 400 x 400 / 600 x 500 / 600 x 400
- Casiers à verres à fond plat ou pour verres inclinés en 500x500 et 400x400 (*existe aussi en format 600x400 spécial logistique*)
- Identification facile grâce aux 7 coloris de rehausse et aux options de personnalisation



Casier à couverts  **P.U**
 500 x 500 mm 1 **204587** **27,13€**



Casier à assiettes à picots  **P.U**
 40 picots
 500 x 500 mm 1 **204585** **27,72€**



Casier assiettes creuses ou plates (sans fond)  **P.U**
 500 x 500 mm 1 **204586** **27,72€**



Casier de base R500  **P.U**
 500 x 500 mm 1 **204591** **28,94€**



Panier à couverts  **P.U**
 8 compartiments 1 **204588** **15,29€**



Godet à couvert CBS  **P.U**
 1 **204589** **1,67€**



Casier fond plat  **P.U**
 500 x 500 mm 1 **204590** **26,54€**

HYGIÈNE

Casiers de lavage



Casier à plateaux **P.U.**
500 x 500 mm 1 **204592** **27,72€**

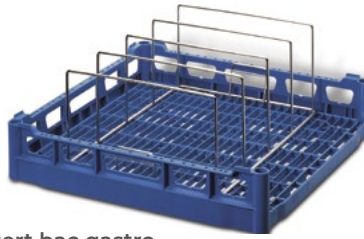

Insert bac gastro
WHT5 + casier
découpé 1 côté **P.U.**
Casier 500 x 500 mm 1 **206950** **91,52€**

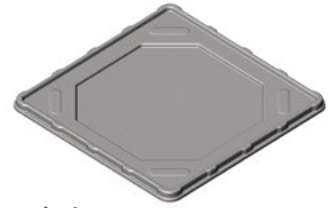

Egouttoir de
comptoir /
couvercle AWAT **P.U.**
Pour casiers 500 x
500 mm 1 **205748** **42,21€**



Kit Bistrosset 396 **P.U.**
2 casiers R396 + 4
repose-verres + 1
porte-assiettes PI400
+ 1 godet à couverts 1 **204595** **55,52€**



Casier de base XL-B **P.U.**
600 x 500 mm 1 **204596** **45,44€**



Casier à assiettes
XL-P **P.U.**
600 x 500 mm 1 **204597** **45,44€**



Casier à plateaux
XL-T **P.U.**
600 x 500 mm 1 **204598** **45,44€**



Housse de
protection **P.U.**
540 x 540 X 1600 mm
Pour casiers 500 x
500 mm 1 **204600** **62,43€**
Pour casiers 400 x
400 mm 1 **204602** **72,91€**



Chariot ROL 400 **P.U.**
Pour casiers 400 x
400 mm 1 **204601** **150,63€**



Chariot ROL 500 **P.U.**
Pour casiers 500 x
500 mm 1 **204599** **209,97€**



FRIES BOX - CAISSE DE TRANSPORT DE VAISSELLE

«Le système de transport parfait de FRIES pour la restauration et les traiteurs»,

Avec la FRIES BOX, toutes les dimensions d'assiettes jusqu'à 32 cm peuvent être conservées et transportées de manière sécurisée et propre. Elle s'adapte également parfaitement à d'autres marchandises,

Dimensions extérieures : L 400 x l 400 x h 315 mm
Dimensions intérieures : L 325 x l 325 x h 270 mm

- Manipulation simple
- Polypropylène de qualité alimentaire
- Utilisable de manière variée
- Empilable et compacte
- OUIES de ventilation



FRIES BOX - Caisse de transport modulaire P.U

Environ 24 assiettes de Ø 26 cm
Environ 60 assiettes de Ø 19 cm

1 204603 14,78€



Tube de positionnement Vary-tool pour FRIES BOX

1 204609 2,86€



Intercalaires pour compartimenter la FRIES BOX

Dessus 1 204610 1,30€
Dessous 1 204611 1,30€



Couvercle pour FRIES BOX

| | | P.U |
|---------------|----------|-------|
| ○ Transparent | 1 204604 | 5,21€ |
| ● Rouge | 1 204605 | 5,21€ |
| ● Jaune | 1 204606 | 5,21€ |
| ● Vert | 1 204607 | 5,21€ |
| ● Bleu | 1 204608 | 5,21€ |



CASIER À VERRES 400X400

CALCULEZ VOUS-MÊME LE PRIX DE VOTRE CASIER EN FONCTION DE LA HAUTEUR ET DU DIAMÈTRE DU VERRE

NOUS CONSULTER POUR LES CASIERS À VERRES INCLINÉS 400 X 400

Casier à verres 400 x 400 à fond plat, coloris gris

| H. max verres | ☛ | 6,5 cm | 12 cm | 13,2 cm | 14,4 cm | 15,6 cm | 16,8 cm | P.U |
|-----------------------|---|--------|--------|---------|---------|---------|---------|--------|
| 9 cases (11,5x11,5cm) | 1 | 204700 | 204703 | 204725 | 204728 | 204731 | 204734 | 23,98€ |
| 16 cases (8,8x8,8cm) | 1 | 204701 | 204704 | 204726 | 204729 | 204732 | 204735 | 23,98€ |
| 25 cases (6,8x6,8cm) | 1 | 204702 | 204705 | 204727 | 204730 | 204733 | 204736 | 23,98€ |

| H. max verres | ☛ | 18 cm | 19,2 cm | 20,4 cm | 21,6 cm | 22,8 cm | 24 cm | P.U |
|-----------------------|---|--------|---------|---------|---------|---------|--------|--------|
| 9 cases (11,5x11,5cm) | 1 | 204737 | 204706 | 204740 | 204743 | 204746 | 204709 | 38,68€ |
| 16 cases (8,8x8,8cm) | 1 | 204738 | 204707 | 204741 | 204744 | 204747 | 204710 | 38,68€ |
| 25 cases (6,8x6,8cm) | 1 | 204739 | 204708 | 204742 | 204745 | 204748 | 204711 | 38,68€ |

| H. max verres | ☛ | 25,2 cm | 26,4 cm | P.U |
|-----------------------|---|---------|---------|--------|
| 9 cases (11,5x11,5cm) | 1 | 204749 | 204752 | 52,21€ |
| 16 cases (8,8x8,8cm) | 1 | 204750 | 204753 | 52,21€ |
| 25 cases (6,8x6,8cm) | 1 | 204751 | 204754 | 52,21€ |



| Grille de protection NHG400 | ☛ | P.U |
|-----------------------------|---|---------------|
| Pour casiers 400 x 400 | 1 | 205750 27,13€ |

| Grille de protection NHG500 | ☛ | P.U |
|-----------------------------|---|---------------|
| Pour casiers 500 x 500 | 1 | 205749 29,15€ |

CASIER À VERRES 500X500

H. max verres

NOUS CONSULTER POUR LES CASIERS À VERRES INCLINÉS CUSTOMRACK 500 X 500

Casier à verres CLIXRACK 500 x 500 à fond plat, coloris gris, rehausse en gris par défaut 7 coloris de rehausse au choix :

- gris
- bleu
- vert
- jaune
- rouge
- orange
- noir



| | ☛ | P.U | P.U | P.U | P.U | P.U | P.U | P.U | P.U | P.U | P.U | | |
|------------------------|---|--------|--------|--------|--------|--------|--------|--------|--------|--------|--------|--------|--------|
| 9 cases (15x15cm) | 1 | 204612 | 34,82€ | 204620 | 42,67€ | 204628 | 49,27€ | 204636 | 49,27€ | 204644 | 49,27€ | 204652 | 49,27€ |
| 16 cases (11,3x11,3cm) | 1 | 204613 | 34,82€ | 204621 | 42,67€ | 204629 | 49,27€ | 204637 | 49,27€ | 204645 | 49,27€ | 204653 | 49,27€ |
| 20 cases (max. Ø9,9cm) | 1 | 204614 | 34,82€ | 204622 | 42,67€ | 204630 | 49,27€ | 204638 | 49,27€ | 204646 | 49,27€ | 204654 | 49,27€ |
| 25 cases (9x9cm) | 1 | 204615 | 34,82€ | 204623 | 42,67€ | 204631 | 49,27€ | 204639 | 49,27€ | 204647 | 49,27€ | 204655 | 49,27€ |
| 30 cases (max. Ø8,1cm) | 1 | 204616 | 34,82€ | 204624 | 42,67€ | 204632 | 49,27€ | 204640 | 49,27€ | 204648 | 49,27€ | 204656 | 49,27€ |
| 36 cases (7,4x7,4cm) | 1 | 204617 | 34,82€ | 204625 | 42,67€ | 204633 | 49,27€ | 204641 | 49,27€ | 204649 | 49,27€ | 204657 | 49,27€ |
| 44 cases (max. Ø6,7cm) | 1 | 204618 | 34,82€ | 204626 | 42,67€ | 204634 | 49,27€ | 204642 | 49,27€ | 204650 | 49,27€ | 204658 | 49,27€ |
| 49 cases (6,3x6,3cm) | 1 | 204619 | 39,02€ | 204627 | 46,87€ | 204635 | 53,47€ | 204643 | 53,47€ | 204651 | 53,47€ | 204659 | 53,47€ |

| | ☛ | P.U | P.U | P.U | P.U | P.U | P.U | | | | |
|------------------------|---|--------|--------|--------|--------|--------|--------|--------|--------|--------|--------|
| 9 cases (15x15cm) | 1 | 204660 | 49,27€ | 204668 | 49,27€ | 204676 | 49,27€ | 204684 | 49,27€ | 204692 | 67,83€ |
| 16 cases (11,3x11,3cm) | 1 | 204661 | 49,27€ | 204669 | 49,27€ | 204677 | 49,27€ | 204685 | 49,27€ | 204693 | 67,83€ |
| 20 cases (max. Ø9,9cm) | 1 | 204662 | 49,27€ | 204670 | 49,27€ | 204678 | 49,27€ | 204686 | 49,27€ | 204694 | 67,83€ |
| 25 cases (9x9cm) | 1 | 204663 | 49,27€ | 204671 | 49,27€ | 204679 | 49,27€ | 204687 | 49,27€ | 204695 | 67,83€ |
| 30 cases (max. Ø8,1cm) | 1 | 204664 | 49,27€ | 204672 | 49,27€ | 204680 | 49,27€ | 204688 | 49,27€ | 204696 | 67,83€ |
| 36 cases (7,4x7,4cm) | 1 | 204665 | 49,27€ | 204673 | 49,27€ | 204681 | 49,27€ | 204689 | 49,27€ | 204697 | 67,83€ |
| 44 cases (max. Ø6,7cm) | 1 | 204666 | 49,27€ | 204674 | 49,27€ | 204682 | 49,27€ | 204690 | 49,27€ | 204698 | 67,83€ |
| 49 cases (6,3x6,3cm) | 1 | 204667 | 53,47€ | 204675 | 53,47€ | 204683 | 53,47€ | 204691 | 53,47€ | 204699 | 72,03€ |

En raison d'importantes fluctuations tarifaires, les prix indiqués (hors DROM-COM) sont à titres indicatifs et peuvent évoluer. Merci de vous rapprocher de votre Distributeur/Installateur. Prix de vente conseillé.

HYGIÈNE

Aspirateurs, Autolaveuses



Aspirateur poussière S10 plus Aspirateur professionnel sur cinq roulettes multi-directionnelles.

| Aspirateur poussière S10 plus | | P.U | |
|-------------------------------|---|--------|---------|
| 1100 watts / 230 V | 1 | 201921 | 263,87€ |
| Sacs S10 + 1 x 10 sacs | 1 | 204496 | 19,53€ |



| Aspirateur eau et poussière SW 22 | | P.U | |
|-----------------------------------|---|--------|---------|
| Contenance 20 lt - 1x1400W | 1 | 202717 | 232,13€ |
| Sacs par paquet de 5 | 1 | 205270 | 21,96€ |



| Monobrosse 160 LS Basse vitesse POWERDISC L5160 | | P.U | |
|---|---|--------|----------|
| Brosse | 1 | 201248 | 1123,82€ |
| Plateau | 1 | 201249 | 1137,61€ |



| Autolaveuse batterie | | P.U | |
|----------------------|---|--------|----------|
| Modèle RA355IBC | 1 | 201925 | 3059,39€ |



| Autolaveuse avec câble Suceur courbé | | P.U | |
|--------------------------------------|---|--------|----------|
| Modèle RA501 E | 1 | 205751 | 3110,20€ |



| Détergent dégraissant Clean Gen | | P.U | |
|---------------------------------|---|--------|--------|
| 3 x 5 lt | 1 | 205798 | 65,88€ |



| Chariot de nettoyage | | P.U | |
|------------------------------|---|--------|---------|
| 2 seaux de 25 lt avec presse | 1 | 202697 | 143,85€ |



| Chariot de nettoyage | | P.U | |
|-----------------------------|---|--------|--------|
| 1 seau de 25 lt avec presse | 1 | 202698 | 90,45€ |



| Panneau de signalisation sol glissant | | P.U | |
|---------------------------------------|---|--------|--------|
| 60 cm | 5 | 203754 | 21,85€ |

HYGIÈNE

Balais, Pelle



Pelle sans couvercle avec manche
Plastique

L 30,5 - H. 94 cm 1 **203391** 14,06€



Tapis anti-dérapant "ATLANTIC"
Dos à base de vinyl anti-dérapant.

90 x 150 cm 1 **201269** 36,83€



Porte balai mural 3 positions

L 50 cm 1 **201266** 47,46€



Frottoir En polyester

Fibre dure 26,5 cm 1 **201129** 20,37€



Balai En polyester

Fibre souple 27,5 cm 1 **201130** 18,66€



Manches vissants Adaptables tous balais. Ø 25 mm. Pas de vis universel.

Fibre de verre 140 cm 1 **201131** 20,61€

Aluminium anodisé 140 cm 1 **204280** 14,09€



Manche en aluminium Compatible avec support pour lavage '205771'

L 140 cm 1 **205770** 7,95€



Raclette renforcée Monture polypropylène. Renforcée en fibre de verre.

55 cm 1 **204277** 22,56€

75 cm 1 **204278** 28,61€



Raclette sol monobloc Monture polypropylène. Renforcée en fibre de verre.

35 cm 1 **204273** 5,81€

45 cm 1 **204274** 6,14€

55 cm 1 **204275** 12,99€

75 cm 1 **204276** 16,95€



Support pour lavage à plat Pliables pour fixer la frange '205772'. Essorage dans une presse à mâchoire. Possède une douille de vissage.

Support pour lavage à plat

L 18 cm 1 **205771** 31,13€



Frange de lavage à plat En polycoton.

L 40 x 17 cm 1 **205772** 8,81€

HYGIÈNE

Conteneurs poubelles

Conteneur en plastique Contivia 2
120 L. 10,4 kg. Polyéthylène. Roues antitraces
Ø 200 mm. Dim. ext. : 875 x 927 x 543 mm.
Dim. int. : 480 x 480 x 200 mm.



| | ☒ | | P.U |
|--------|---|--------|--------|
| Gris | 1 | 204256 | 71,50€ |
| Jaune | 1 | 204257 | 71,50€ |
| Bleu | 1 | 204258 | 71,50€ |
| Vert | 1 | 204259 | 71,50€ |
| Marron | 1 | 204260 | 71,50€ |
| Blanc | 1 | 204261 | 71,50€ |

Conteneur 240 L - 2 roues
57,3 x 71,5 x 106,2 cm



| | ☒ | | P.U |
|--------|---|--------|---------|
| Gris | 1 | 202702 | 108,72€ |
| Jaune | 1 | 202703 | 108,72€ |
| Bleu | 1 | 202704 | 108,72€ |
| Vert | 1 | 202705 | 108,72€ |
| Marron | 1 | 202706 | 108,72€ |
| Blanc | 1 | 202707 | 108,72€ |

Conteneur 660 L - 4 roues
137 x 78,4 x 121,5 cm



| | ☒ | | P.U |
|--------|---|--------|---------|
| Gris | 1 | 202731 | 438,51€ |
| Jaune | 1 | 202732 | 438,51€ |
| Bleu | 1 | 202733 | 438,51€ |
| Vert | 1 | 202734 | 438,51€ |
| Marron | 1 | 202735 | 438,51€ |

Polyéthylène haute densité avec protection anti-UV. Larges poignées sur le couvercle. Roues en caoutchouc Ø 200, portée 100 kg/roue. Vidage par prise frontale.

Poubelle à pédale 50 L
34,5 x 41 x 58 cm



| | ☒ | | P.U |
|-------|---|--------|--------|
| Blanc | 1 | 206840 | 52,11€ |
| Vert | 1 | 206841 | 52,11€ |
| Rouge | 1 | 206842 | 52,11€ |
| Jaune | 1 | 206843 | 52,11€ |
| Bleu | 1 | 206844 | 52,11€ |

Collecteur à pédale 100 L - 2 roues
8,5 kg. Polypropylène. Roues antitraces Ø
100 mm. Dim. ext. : 515 x 485 x 922 mm. Dim.
int. : 390 x 280 x 740 mm



| | ☒ | | P.U |
|-----------------|---|--------|---------|
| Couvercle blanc | 1 | 230101 | 175,61€ |
| Couvercle bleu | 1 | 230102 | 175,61€ |
| Couvercle vert | 1 | 230103 | 175,61€ |
| Couvercle rouge | 1 | 230104 | 175,61€ |
| Couvercle jaune | 1 | 230105 | 175,61€ |

Support sac 120 litres
Structure ABS, couvercle couleur, ouverture
à pédale, équipé de 2 roues - large ouverture



| | ☒ | | P.U |
|-----------------|---|--------|---------|
| Couvercle blanc | 1 | 203056 | 105,30€ |
| Couvercle bleu | 1 | 203831 | 105,30€ |
| Couvercle vert | 1 | 203832 | 105,30€ |
| Couvercle rouge | 1 | 203833 | 105,30€ |
| Couvercle jaune | 1 | 203834 | 105,30€ |

Corps et couvercle en polyéthylène haute densité, Couvercles colorés pour faciliter la collecte sélective, Large pédale pour utilisation conforme à la méthode HACCP,



Borne à déchets à trappe basculante **P.U**

| | | | |
|------------------|---|---------------|----------------|
| Inox brossé 50 L | 1 | 204252 | 363,06€ |
| Acier blanc 50 L | 1 | 204253 | 330,33€ |
| Inox brossé 50 L | 1 | 204254 | 31,13€ |
| Acier blanc 50 L | 1 | 204255 | 31,14€ |



Borne à déchets à trappe basculante **P.U**

| | | | |
|-------------------|---|---------------|----------------|
| Inox brossé 120 L | 1 | 204250 | 525,97€ |
| Support plateau | | | P.U |
| Inox brossé 120 L | 1 | 204251 | 38,26€ |



| | | | |
|--------------------------------|----|---------------|---------------|
| Sacs poubelle et container | | | P.U |
| 30 L 35 mµ, colis de 500 sacs | 2 | 204712 | 28,37€ |
| 50 L 35 mµ, colis de 500 sacs | 2 | 204713 | 50,58€ |
| 110 L 45 mµ, colis de 200 sacs | 5 | 204716 | 62,85€ |
| 130 L 55 mµ, colis de 100 sacs | 10 | 204719 | 51,67€ |
| 150 L 65 mµ, colis de 100 sacs | 10 | 204720 | 64,23€ |
| 330 L 30 mµ - 100 housses | | 206951 | 71,98€ |
| 750 L 30 mµ - 50 housses | | 206952 | 55,72€ |



| | | | |
|---|---|---------------|----------------|
| Support sac mobile à pédale acier blanc 55 x 58 x 97,5 cm | | | P.U |
| Sans couvercle | 1 | 202741 | 139,40€ |
| Couvercle jaune | 1 | 202742 | 144,94€ |
| Couvercle bleu | 1 | 202743 | 144,94€ |
| Couvercle rouge | 1 | 202744 | 144,94€ |
| Couvercle vert | 1 | 202745 | 144,94€ |



Porte-sac à pinces Livré déjà monté **P.U**

| | | | |
|-------------------|---|---------------|----------------|
| Sac de 110 litres | 1 | 230016 | 187,20€ |
|-------------------|---|---------------|----------------|



| | | | |
|---|---|---------------|----------------|
| Porte-sac inox H 90 cm pour sacs 100 lt | | | P.U |
| Avec habillage | 1 | 204067 | 282,74€ |
| Sans habillage | 1 | 205027 | 195,00€ |



Bac amovible A posé sur la structure inférieure **P.U**

| | | | |
|-------------|---|---------------|---------------|
| Pour 205027 | 1 | 205757 | 48,96€ |
|-------------|---|---------------|---------------|



| | | | |
|-------------------------------------|---|---------------|----------------|
| Table centrale | | | P.U |
| 2 porte-sacs - 120 x 60 x 90 cm | 1 | 202747 | 776,83€ |
| 3 porte-sacs - 170 x 60 x 90 cm | 1 | 202748 | 982,87€ |
| Porte-sacs supplémentaire - H 80 cm | 1 | 202749 | 144,97€ |



Porte-sac à pinces **P.U**

| | | | |
|-------------------|---|---------------|----------------|
| Sac de 110 litres | 1 | 206845 | 143,55€ |
|-------------------|---|---------------|----------------|

Collecteur à déchets Polypropylène. Axes et tringlerie inox pour sac de 110 L. Roues Ø 12,5 cm. Couvercle et pédale disponible en 4 coloris - table non fournie 78 x 54 x 62 cm



| | | | |
|-----------|---|---------------|----------------|
| | | | P.U |
| Bleu | 1 | 200904 | 603,52€ |
| Jaune | 1 | 200905 | 603,52€ |
| Vert | 1 | 200906 | 603,52€ |
| Framboise | 1 | 200907 | 603,52€ |

HYGIÈNE

Chariots à linge



Chariot à linge composite avec 4 portes

Structure polyéthylène monobloc. H 1260 mm x L 1550 mm x P 565 mm. Replié 1200 mm. 4 roues pivotantes. 3 rayons espacés de 270 mm. Dimensions utiles des rayons : 700 mm x 460 mm. Vendu sans sac.

| | 📦 | Sans support sac | P.U | Avec 2 supports sac | P.U |
|-------------------|---|------------------|-----------------|---------------------|-----------------|
| Portes bleues | 1 | 302523 | 1193.76€ | 204286 | 1193.76€ |
| Portes noires | 1 | 204284 | 1193.76€ | 204287 | 1193.76€ |
| Portes framboises | 1 | 204285 | 1193.76€ | 204288 | 1193.76€ |



Chariot à linge composite sans porte

Structure polyéthylène monobloc. H 1260 mm x L 1550 mm x P 565 mm. Replié 1200 mm. 4 roues pivotantes. 3 rayons espacés de 270 mm. Dimensions utiles des rayons : 700 mm x 460 mm. Vendu sans sac.

| | 📦 | P.U |
|---------------------|---|------------------------|
| Sans support sac | 1 | 302524 977,35€ |
| Avec 2 supports sac | 1 | 201093 1212,21€ |



Chariot pour corbeilles à linge
Acier epoxy

1 **205759 506,44€**

Vendu séparément



Corbeille à linge professionnel

| | 📦 | P.U |
|-------------------------|---|----------------------|
| 60 L - 61 x 40 x 27 cm | 1 | 200081 18,23€ |
| 100 L - 72 x 48 x 29 cm | 1 | 200083 35,53€ |
| 130 L - 79 x 57 x 29 cm | 1 | 200085 42,61€ |



HYGIÈNE

Chariots à linge



Chariot à change et toilette

Maniabilité 4 roues directionnelles composite sans frein Ø 125 mm. Chariot vendu sans sac.

| | Quantité | Code | P.U |
|--|----------|--------|---------|
| Support sac complet | 1 | 302525 | 125,31€ |
| Support sac haut | 1 | 204290 | 45,86€ |
| Support sac bas | 1 | 204291 | 42,35€ |
| Couvercle seul | 1 | 204292 | 39,90€ |
| Échelle murale inox | 1 | 204293 | 224,02€ |
| Échelle de chariot inox | 1 | 302527 | 178,56€ |
| Lot de 4 supports en fil inox pour bacs plastique | 1 | 302528 | 179,14€ |
| Lot de 4 bacs plastique blanc L 410 x P 315 x H 110 mm | 1 | 302529 | 35,13€ |
| Lot de 3 bases coulissantes inox pour séparation | 1 | 302530 | 116,27€ |
| Lot de 3 bases séparations inox | 1 | 302531 | 124,30€ |
| Réhausse pour chariot de change L 265 x P 500 x H 300 mm | 1 | 204299 | 391,27€ |
| Support poubelle inox + poubelle | 1 | 204300 | 94,39€ |
| Pack de 4 roues jumelées à blocage combiné | 1 | 204301 | 214,21€ |
| Supplément de 2 roues à frein | 1 | 204302 | 21,86€ |
| Serrure | 1 | 204303 | 75,72€ |
| Jeu de 2 portes | 1 | 204304 | 137,98€ |

Pour chariot à change et toilette

| Sac à linge | Quantité | Gris | Orange | Vert | Bleu | P.U |
|-------------|----------|--------|--------|--------|--------|--------|
| | 1 | 204306 | 204307 | 204308 | 302534 | 18,70€ |



Chariot sac à linge
Accrochable - livré sans sacs.

| | Quantité | Bleu | Jaune | Rouge | Vert | P.U |
|----------------|----------|--------|--------|--------|--------|---------|
| 40 x 30 x 2 cm | 1 | 205051 | 205052 | 205053 | 205054 | 399,27€ |



Coffre à linge

70 L - 42,5 x 27 x 64,5 cm

| | Quantité | Code | P.U |
|--|----------|--------|--------|
| | 1 | 205760 | 28,34€ |

TEXTILE

Accessoires



SOMMAIRE | INDEX



| Calot Atlanta | | P.U |
|--------------------|----------|--------|
| 100 % coton, Blanc | 1 363175 | 8,88€ |
| Polycoton, Noir | 1 364134 | 11,58€ |



| Torchon A 100% coton | | P.U |
|-------------------------|----------|--------|
| 77 x 50 cm, lot de 12 | 1 205457 | 14,86€ |



| Essuie-verre Microfibre | | P.U |
|----------------------------|----------|--------|
| 50 x 80 cm, lot de 10 | 1 302170 | 33,21€ |



| Paire de maniques rouges En silicone, résistant à 300°C. | | P.U |
|---|----------|--------|
| 20 x 13 cm | 1 203741 | 35,80€ |



| Moufle Ultigrip® | | P.U |
|------------------|----------|--------|
| 43,2 cm | 1 206149 | 35,30€ |



| Gant antichaleur ambidextre | | P.U |
|--------------------------------|----------|--------|
| TU - 31 cm | 1 205762 | 16,73€ |



| Gants de four à 5 doigts 2 pièces / Set | | P.U |
|---|----------|--------|
| 36 cm | 1 206150 | 42,48€ |



| Gant silicone Antidérapant, résistant à 300°C, | | P.U |
|---|----------|--------|
| 29 cm | 1 299486 | 24,23€ |
| 42 cm | 1 299487 | 41,65€ |

TEXTILE

Tabliers



| Tablier Haley | 📦 | P.U |
|---------------|---|---------------|
| Denim brut | 1 | 206847 31,52€ |
| Denim délavé | 1 | 206848 31,52€ |



| Tablier Harold | 📦 | P.U |
|----------------|---|---------------|
| Denim brut | 1 | 206849 36,25€ |
| Denim délavé | 1 | 206850 36,25€ |



Tablier Prague
Bretelle de fermeture réglable par boucle.
Ceinture lacette tresse,
tissu : 100 cm H 120 x L 100 cm

| | 📦 | P.U |
|----------|---|---------------|
| Blanc | 1 | 205390 20,46€ |
| Bordeaux | 1 | 205391 23,76€ |
| Rouge | 1 | 205392 23,76€ |
| Noir | 1 | 205763 23,91€ |



Tablier Pise
Tablier à bavette. Longueur tour de cou :
60cm. Grande poche centrale. Ceinture
lacette tresse. H 100 x L 105cm. Longueur
ceinture : 100cm

| | 📦 | P.U |
|--------|---|---------------|
| Blanc | 1 | 205393 8,45€ |
| Marine | 1 | 205394 10,18€ |
| Noir | 1 | 205395 8,45€ |



Tablier chef
Tablier long sans bavette,
100 % coton, 100 x 90 cm,

| | 📦 | P.U |
|-------|---|--------------|
| Noir | 1 | 364724 7,19€ |
| Blanc | 1 | 301508 6,9€ |



Tablier 1/2 chef
Tablier court sans bavette,
100 % coton, 100 x 60 cm,

| | 📦 | P.U |
|-------|---|--------------|
| Noir | 1 | 364723 5,80€ |
| Blanc | 1 | 319600 6,38€ |

Tablier Parm
En PVC - Taille unique
H 100 x L 75 cm

| | 📦 | P.U |
|----------|---|---------------|
| Bleu roi | 1 | 206103 26,97€ |
| Blanc | 1 | 206105 19,16€ |



Tablier Loti
Polycoton, tablier bavette lacette cou ajustable
3 boutons pression, 1 poche téléphone sur bave
1 poche centrale bas, L 70 x H 90 cm. Taille unie
Autre coloris nous consulter.

| | 📦 | P.U |
|------------|---|---------------|
| Bordeaux | 1 | 203567 16,71€ |
| Chocolat | 1 | 203568 16,71€ |
| Prune | 1 | 203570 16,71€ |
| Blanc | 1 | 364721 16,71€ |
| Anthracite | 1 | 364722 16,71€ |
| Gris clair | 1 | 364856 16,71€ |
| Noir | 1 | 364858 16,71€ |





Veste femme MC Shade

Une veste de cuisine manches courtes pour femme déclinée en colorama tendance et actuel - à associer avec son pendant masculin. Des détails de finition soulignés par une touche de gris anthracite. Existe en manches longues, 65% polyester 35% coton.

| Taille | | ● Rouge rubis | ● Bleu denim | ○ Blanc | ● Gris denim | ● Olive | ● Noir | P.U |
|--------|---|--|--|--|--|--|---|---------------|
| T.00 | 1 | 206113 | 205829 | 205837 | 205806 | 205821 | 205814 | 31,18€ |
| T.0 | 1 | 206114 | 205830 | 205838 | 205807 | 205822 | 205815 | 31,18€ |
| T.1 | 1 | 206115 | 205828 | 205836 | 205805 | 205820 | 205813 | 31,18€ |
| T.2 | 1 | 206116 | 205827 | 205835 | 205804 | 205819 | 205812 | 31,18€ |
| T.3 | 1 | 206117 | 205826 | 205834 | 205803 | 205818 | 205811 | 31,18€ |
| T.4 | 1 | 206118 | 205825 | 205833 | 205802 | 205817 | 205810 | 31,18€ |
| T.5 | 1 | 206119 | 205824 | 205832 | 205801 | 205816 | 205809 | 31,18€ |
| T.6 | 1 | 206120 | 205823 | 205831 | | | 205808 | 31,18€ |





Veste Bama

Sergé 65% / Polyester / 35% Coton, 1 poche stylo double compartiment sur manche gauche. Col officier. Revers arrondi bas de manches. Boutons-pression cachés.

Veste manches longues

| Taille | ● | Noir | P.U |
|--------|---|--------|--------|
| T.00 | 1 | 364833 | 26,72€ |
| T.0 | 1 | 364832 | 26,72€ |
| T.1 | 1 | 364834 | 26,72€ |
| T.2 | 1 | 364835 | 26,72€ |
| T.3 | 1 | 364836 | 26,72€ |
| T.4 | 1 | 364837 | 26,72€ |
| T.5 | 1 | 364838 | 26,72€ |
| T.6 | 1 | 364839 | 26,72€ |

Veste manches courtes

| Taille | ● | Noir | P.U |
|--------|---|--------|--------|
| T.00 | 1 | 364841 | 25,41€ |
| T.0 | 1 | 364840 | 25,41€ |
| T.1 | 1 | 364842 | 25,41€ |
| T.2 | 1 | 364843 | 25,41€ |
| T.3 | 1 | 364844 | 25,41€ |
| T.4 | 1 | 364845 | 25,41€ |
| T.5 | 1 | 364846 | 25,41€ |
| T.6 | 1 | 364847 | 25,41€ |

Veste femme ML Blackstitch

La veste Blackstitch est une veste innovante, au design et aux technologies empruntés aux sports high tech : bandes thermocollées, couture flatlock. La maille respirante alvéolée positionnée à des endroits stratégiques (intérieur de col, côtés et à l'arrière au niveau des emmanchures) la rend très agréable à porter.



| Taille | ● | Noir | P.U |
|--------|---|--------|--------|
| T.00 | 1 | 206106 | 59,59€ |
| T.0 | 1 | 206107 | 59,59€ |
| T.1 | 1 | 206108 | 59,59€ |
| T.2 | 1 | 206109 | 59,59€ |
| T.3 | 1 | 206110 | 59,59€ |
| T.4 | 1 | 206111 | 59,59€ |
| T.5 | 1 | 206112 | 59,59€ |



Veste Crush

Col officier effet double, ouverture milieu devant par pressions cachées, poche poitrine avec zip inversé, poche stylo sur manche gauche, empiècements en maille respirante forme géométrique sur les côtés et le haut du dos, passepoil contrasté sur col et poche, capuchon de zip contrasté

Veste manches longues Veste manches courtes

| Taille | ● | Blanc/noir | P.U | ● | Ficelle | P.U |
|--------|---|------------|--------|---|---------|-----|
| T.00 | 1 | 205839 | 39,96€ | - | - | - |
| T.0 | 1 | 205840 | 39,96€ | 1 | 206851 | 39€ |
| T.1 | 1 | 205841 | 39,96€ | 1 | 206852 | 39€ |
| T.2 | 1 | 205842 | 39,96€ | 1 | 206853 | 39€ |
| T.3 | 1 | 205843 | 39,96€ | 1 | 206854 | 39€ |
| T.4 | 1 | 205844 | 39,96€ | 1 | 206855 | 39€ |
| T.5 | 1 | 205845 | 39,96€ | 1 | 206857 | 39€ |
| T.6 | 1 | 205846 | 39,96€ | 1 | 206856 | 39€ |



Veste femme Abella manches courtes

Col officier plongeant et intérieur en éponge, veste en nid d'abeille ajustée, devant fermé par boutons-pression cachés, découpes côtés en maille respirante, poche stylo sur manche, 67% polyester / 33% coton.

| Taille | | ● Noir | ○ Blanc | P.U |
|--------|---|--------|---------|--------|
| T.00 | 1 | 206007 | 206020 | 50,17€ |
| T.0 | 1 | - | 206019 | 50,17€ |
| T.1 | 1 | 206006 | 206018 | 50,17€ |
| T.2 | 1 | 206005 | 206017 | 50,17€ |
| T.3 | 1 | 206004 | 206016 | 50,17€ |
| T.4 | 1 | 206003 | 206015 | 50,17€ |
| T.5 | 1 | 206002 | 206014 | 50,17€ |



Veste femme Holly ML

Col mao. Plis épaule. Poche plaquée manche gauche. Boutons pression cachés devant et calottes apparentes haut et bas devant. Bouton clou avec passant pour maintenir le revers de manche. 2 plis dos pour une meilleure aisance. Réglage bas vêtement par pattes + boutons clous dans le dos.

| Taille | | ● Denim brut | ● Denim délavé | P.U |
|--------|---|--------------|----------------|--------|
| T.00 | 1 | 206880 | 206887 | 39,94€ |
| T.0 | 1 | 206879 | 206886 | 39,94€ |
| T.1 | 1 | 206878 | 206885 | 39,94€ |
| T.2 | 1 | 206877 | 206884 | 39,94€ |
| T.3 | 1 | 206876 | 206883 | 39,94€ |
| T.4 | 1 | 206875 | 206882 | 39,94€ |
| T.5 | 1 | 206874 | 206881 | 39,94€ |

Veste femme ML Elbax

Veste manche longue, 65% Polyester 35% Coton. Col officier de couleur, boutons-pression cachés, pinces poitrine, surpiqûres contrastées : plastron + épaules + dos Liserés contrastés : plastron + poche poitrine. Revers bas de manches longues contrastés, bande en maille respirante sur les côtés, poche stylo sur manche. Existe aussi en manches courtes.



Existe en MC nous consulter

| Taille | | ● Blanc/Noir | P.U |
|--------|---|--------------|--------|
| T.00 | 1 | 205383 | 34,18€ |
| T.0 | 1 | 205382 | 34,18€ |
| T.1 | 1 | 205384 | 34,18€ |
| T.2 | 1 | 205385 | 34,18€ |
| T.3 | 1 | 205386 | 34,18€ |
| T.4 | 1 | 205387 | 34,18€ |
| T.5 | 1 | 205388 | 34,18€ |



Veste femme Unera MC

Col officier. Veste de cuisine ajustée manches courtes finies par des ourlets. Découpes princesses devant et dos. Fermeture par boutons pressions cachés. Pincés poitrine 1 poche stylo plaquée sur la manche gauche avec liseré, 65% polyester 35% coton.

| Taille | | Blanc | Prune | P.U | Taille | | Nude | Anthracite | Pistache | Framboise | Noir | P.U |
|--------|---|--------|--------|--------|--------|---|--------|------------|----------|-----------|--------|--------|
| T.00 | 1 | - | 107962 | 27,30€ | T.00 | 1 | 206157 | 206164 | 206171 | 206178 | 206185 | 29,08€ |
| T.0 | 1 | 107983 | 107961 | 27,30€ | T.0 | 1 | 206156 | 206163 | 206170 | 206177 | 206184 | 29,08€ |
| T.1 | 1 | 107984 | 107963 | 27,30€ | T.1 | 1 | 206155 | 206162 | 206169 | 206176 | 206183 | 29,08€ |
| T.2 | 1 | 107985 | 107964 | 27,30€ | T.2 | 1 | 206154 | 206161 | 206168 | 206175 | 206182 | 29,08€ |
| T.3 | 1 | 107986 | 107965 | 27,30€ | T.3 | 1 | 206153 | 206160 | 206167 | 206174 | 206181 | 29,08€ |
| T.4 | 1 | 107987 | 107966 | 27,30€ | T.4 | 1 | 206152 | 206159 | 206166 | 206173 | 206180 | 29,08€ |
| T.5 | 1 | 107988 | 107967 | 27,30€ | T.5 | 1 | 206151 | 206158 | 206165 | 206172 | 206179 | 29,08€ |

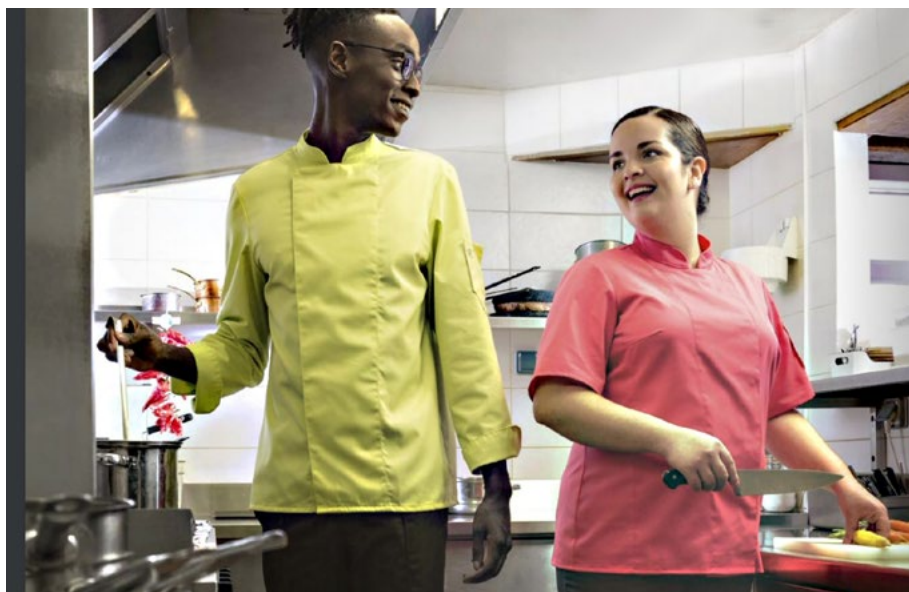



Pantalon Izia

Coupe droite, ceinture 5 passants, système de réglage taille avec élastique intérieur ceinture. Fermeture bouton et braguette zippée, 2 poches italiennes devant, 1 poche passepoilée dos. Entrejambe 76 cm + ourlet détachable de 5 cm, 62% polyester 34% coton 4% stretch EOL,

| Taille | Noir | P.U |
|--------|----------|--------|
| T.34 | 1 206858 | 35,72€ |
| T.36 | 1 206859 | 35,72€ |
| T.38 | 1 206860 | 35,72€ |
| T.40 | 1 206861 | 35,72€ |
| T.42 | 1 206862 | 35,72€ |
| T.44 | 1 206863 | 35,72€ |
| T.46 | 1 206864 | 35,72€ |
| T.48 | 1 206865 | 35,72€ |
| T.50 | 1 206866 | 35,72€ |
| T.52 | 1 206867 | 35,72€ |



Pantalon Slack

Ceinture avec 5 passants, poches italiennes, poche passepoilée dos, braguette avec fermeture à glissière et bouton clou. Sergé 64% polyester, 33% coton, 3% stretch EOL,

| Taille | Noir | P.U |
|--------|----------|--------|
| T.34 | 1 205858 | 42,72€ |
| T.36 | 1 205857 | 42,72€ |
| T.38 | 1 205856 | 42,72€ |
| T.40 | 1 205855 | 42,72€ |
| T.42 | 1 205854 | 42,72€ |
| T.44 | 1 205853 | 42,72€ |
| T.46 | 1 205852 | 42,72€ |
| T.48 | 1 205851 | 42,72€ |
| T.50 | 1 205850 | 42,72€ |
| T.52 | 1 205849 | 42,72€ |
| T.54 | 1 205848 | 42,72€ |
| T.56 | 1 205847 | 42,72€ |



Pantalon femme Adélie

Ceinture avec élastique côtés + bouton clou, braguette fermée par boutons pression, poches italiennes, poche dos plaquée et fermée par un bouton pression, pinces dos, ourlets bas de jambes. Polyester - Coton.

AUTRES COULEURS DISPO

- Bleu marine
- Blanc

| Taille | Noir | Blanc | P.U |
|--------|----------|----------|--------|
| T.34 | 1 205180 | 1 206900 | 26,85€ |
| T.36 | 1 205181 | 1 206899 | 26,85€ |
| T.38 | 1 205182 | 1 206898 | 26,85€ |
| T.40 | 1 205183 | 1 206897 | 26,85€ |
| T.42 | 1 205184 | 1 206896 | 26,85€ |
| T.44 | 1 205185 | 1 206895 | 26,85€ |
| T.46 | 1 205186 | 1 206894 | 26,85€ |
| T.48 | 1 205187 | 1 206893 | 26,85€ |
| T.50 | 1 205188 | 1 206892 | 26,85€ |
| T.52 | 1 205189 | 1 206891 | 26,85€ |
| T.54 | 1 205190 | 1 206890 | 26,85€ |
| T.56 | 1 205191 | 1 206889 | 26,85€ |
| T.58 | 1 205192 | 1 206888 | 26,85€ |



Veste Blake MC
Veste manches courtes, col officier, poche crayon sur manche gauche, boutons-pression calottés gris, 65 % polyester, 35 % coton



Veste Blake ML
Veste manches longues, col officier, poche crayon, revers arrondi bas de manches, boutons-pression calottés gris, 65 % polyester, 35 % coton.



Veste homme Crush
Col officier effet double, ouverture milieu devant par pressions cachées, poche poitrine avec zip inversé, poche stylo sur manche gauche, empiècements en maille respirante forme géométrique sur les côtés et le haut du dos, passepoil contrasté sur col et poche, capuchon de zip contrasté.

| Taille | ● Noir | |
|--------|----------|--------|
| | ● | P.U |
| T.XS | 1 364156 | 24,88€ |
| T.S | 1 364488 | 24,88€ |
| T.M | 1 364489 | 24,88€ |
| T.L | 1 364490 | 24,88€ |
| T.XL | 1 364491 | 24,88€ |
| T.XXL | 1 364492 | 24,88€ |
| T.XXXL | 1 364493 | 24,88€ |

| Taille | ● Noir | |
|--------|----------|--------|
| | ● | P.U |
| T.XS | 1 364155 | 26,28€ |
| T.S | 1 364482 | 26,28€ |
| T.M | 1 364483 | 26,28€ |
| T.L | 1 364484 | 26,28€ |
| T.XL | 1 364485 | 26,28€ |
| T.XXL | 1 364486 | 26,28€ |
| T.XXXL | 1 364487 | 26,28€ |

| Taille | ● Blanc/Noir | | ● Ficelle | |
|--------|--------------|--------|-----------|--------|
| | ● | P.U | ● | P.U |
| T.00 | 1 205865 | 37,28€ | - | - |
| T.0 | 1 205866 | 37,28€ | - | - |
| T.1 | 1 205864 | 37,28€ | 1 206868 | 39,00€ |
| T.2 | 1 205863 | 37,28€ | 1 206869 | 39,00€ |
| T.3 | 1 205862 | 37,28€ | 1 206870 | 39,00€ |
| T.4 | 1 205861 | 37,28€ | 1 206871 | 39,00€ |
| T.5 | 1 205860 | 37,28€ | 1 206872 | 39,00€ |
| T.6 | 1 205859 | 37,28€ | 1 206873 | 39,00€ |



Existe en ML

Veste homme Shade

Col officier, fermeture par pressions cachées, poche stylo double compartiment sur manche gauche, découpes dos, demi-lune et intérieur col contrastés. Existe en manches longues, 65% polyester 35% coton.

| Taille | ● | | | | | | | | P.U |
|--------|--------------|--------------|--------|---------|-------------|---------------|--------------|---------|--------|
| | ● Bleu denim | ● Gris denim | ● Noir | ● Olive | ● Bleu azur | ● Rouge rubis | ● Anthracite | ● Blanc | |
| T.0 | 1 204477 | 205873 | 205880 | 205887 | 205894 | 205901 | 205908 | 205915 | 28,67€ |
| T.1 | 1 204478 | 205872 | 205879 | 205886 | 205893 | 205900 | 205907 | 205914 | 28,67€ |
| T.2 | 1 204479 | 205871 | 205878 | 205885 | 205892 | 205899 | 205906 | 205913 | 28,67€ |
| T.3 | 1 204480 | 205870 | 205877 | 205884 | 205891 | 205898 | 205905 | 205912 | 28,67€ |
| T.4 | 1 204481 | 205869 | 205876 | 205883 | 205890 | 205897 | 205904 | 205911 | 28,67€ |
| T.5 | 1 204482 | 205868 | 205875 | 205882 | 205889 | 205896 | 205903 | 205910 | 28,67€ |
| T.6 | 1 204483 | 205867 | 205874 | 205881 | 205888 | 205895 | 205902 | 205909 | 28,67€ |



Pantalon homme Flex'r

Ceinture en maille élastiquée, braguette zippée, 2 poches italiennes, genoux préformés, 1 poche cuisse avec rabat pressionné et 1 compartiment stylo, 1 poche arrière passepoilée,

| Taille | 🔲 | ● Anthracite | | ● Gris clair | | ● Noir | |
|--------|---|--------------|--------|--------------|--------|--------|--------|
| | | P.U | P.U | P.U | P.U | | |
| T.00 | 1 | 205925 | 47,72€ | 205916 | 47,72€ | 364927 | 47,72€ |
| T.0 | 1 | 205926 | 47,72€ | 204484 | 47,72€ | 364928 | 47,72€ |
| T.1 | 1 | 205924 | 47,72€ | 204485 | 47,72€ | 364929 | 47,72€ |
| T.2 | 1 | 205923 | 47,72€ | 204486 | 47,72€ | 364930 | 47,72€ |
| T.3 | 1 | 205922 | 47,72€ | 204487 | 47,72€ | 364931 | 47,72€ |
| T.4 | 1 | 205921 | 47,72€ | 204488 | 47,72€ | 364932 | 47,72€ |
| T.5 | 1 | 205920 | 47,72€ | 204489 | 47,72€ | 364933 | 47,72€ |
| T.6 | 1 | 205919 | 47,72€ | 204490 | 47,72€ | 364934 | 47,72€ |
| T.7 | 1 | 205918 | 62,04€ | 204491 | 56,00€ | 205917 | 62,04€ |

Pantalon homme Slack

Un pantalon de cuisinier à la coupe chino : un confort exceptionnel au porté. Ceinture avec 5 passants, poches italiennes, poche passepoilée dos, braguette avec fermeture à glissière et bouton clou. 64% polyester / 33% coton / 3% elastolefin.

| Taille | 🔲 | ● Noir | |
|--------|---|--------|--------|
| | | P.U | P.U |
| T.60 | 1 | 205927 | 41,01€ |
| T.58 | 1 | 205928 | 41,01€ |
| T.56 | 1 | 205929 | 41,01€ |
| T.54 | 1 | 205930 | 41,01€ |
| T.52 | 1 | 205931 | 41,01€ |
| T.50 | 1 | 205932 | 41,01€ |
| T.48 | 1 | 205933 | 41,01€ |
| T.46 | 1 | 205934 | 41,01€ |
| T.44 | 1 | 205935 | 41,01€ |
| T.42 | 1 | 205936 | 41,01€ |
| T.40 | 1 | 205937 | 41,01€ |
| T.38 | 1 | 205938 | 41,01€ |
| T.36 | 1 | 205939 | 41,01€ |
| T.34 | 1 | 205940 | 41,01€ |

Pantalon homme PBO3

Un pantalon de cuisine confort pour une efficacité en toutes circonstances grâce à sa coupe droite et sa ceinture élastiquée. Ceinture élastiquée, plis devant 2 poches devant en biais, 1 poche passepoilée arrière, braguette à glissière, 65% polyester 35% coton

| Taille | 🔲 | ● Gris anthracite | | | P.U | ● Noir | P.U |
|--------|---|-------------------|-----------|-------------------|--------|--------|--------|
| | | ○ Blanc | ● Ficelle | ● Gris anthracite | | | |
| T.34 | 1 | - | 205956 | 205986 | 33,08€ | 205972 | 33,08€ |
| T.36 | 1 | 206001 | 205955 | 205985 | 33,08€ | 205971 | 33,08€ |
| T.62 | 1 | 205988 | 205942 | - | - | 205958 | 33,08€ |
| T.38 | 1 | 206000 | 205954 | 205984 | 33,08€ | 205970 | 33,08€ |
| T.40 | 1 | 205999 | 205953 | 205983 | 33,08€ | 205969 | 33,08€ |
| T.42 | 1 | 205998 | 205952 | 205982 | 33,08€ | 205968 | 33,08€ |
| T.44 | 1 | 205997 | 205951 | 205981 | 33,08€ | 205967 | 33,08€ |
| T.46 | 1 | 205996 | 205950 | 205980 | 33,08€ | 205966 | 33,08€ |
| T.48 | 1 | 205995 | 205949 | 205979 | 33,08€ | 205965 | 33,08€ |
| T.50 | 1 | 205994 | 205948 | 205978 | 33,08€ | 205964 | 33,08€ |
| T.52 | 1 | 205993 | 205947 | 205977 | 33,08€ | 205963 | 33,08€ |
| T.54 | 1 | 205992 | 205946 | 205976 | 33,08€ | 205962 | 33,08€ |
| T.56 | 1 | 205991 | 205945 | 205975 | 33,08€ | 205961 | 33,08€ |
| T.58 | 1 | 205990 | 205944 | 205974 | 33,08€ | 205960 | 33,08€ |
| T.60 | 1 | 205989 | 205943 | 205973 | 33,08€ | 205959 | 33,08€ |
| T.64 | 1 | 205987 | 205941 | - | - | 205957 | 42,99€ |





Veste mixte Siaka

L'intérieur du col est en éponge pour une bonne absorption de l'humidité et confort. La maille respirante dotée de la technologie Cool Plus® permet une évacuation de la transpiration et un séchage rapide afin de préserver le bien-être. Col officier + intérieur en éponge. Veste en nid d'abeille ajustée. Boutons-pression cachés. Découpes côtés en maille respirante. Poche stylo sur manche. Fentes dos. Existe aussi en ML.

| Taille | | ● Noir | ○ Blanc | P.U |
|--------|---|--------|---------|--------|
| T.0 | 1 | 210761 | 210768 | 50,17€ |
| T.1 | 1 | 210760 | 210767 | 50,17€ |
| T.2 | 1 | 210759 | 210766 | 50,17€ |
| T.3 | 1 | 210758 | 210765 | 50,17€ |
| T.4 | 1 | 210757 | 210764 | 50,17€ |
| T.5 | 1 | 210756 | 210763 | 50,17€ |
| T.6 | 1 | 210755 | 210762 | 50,17€ |



Veste mixte Carne

Col officier. Boutons pression cachés. Maille sur côtés. Maille contrastée sur épaules, manches, haut du col et intérieur de col. Fentes côtés.

| Taille | | ● Noir cerise | P.U |
|--------|---|---------------|--------|
| T.0 | 1 | 206907 | 40,19€ |
| T.1 | 1 | 206906 | 40,19€ |
| T.2 | 1 | 206905 | 40,19€ |
| T.3 | 1 | 206904 | 40,19€ |
| T.4 | 1 | 206903 | 40,19€ |
| T.5 | 1 | 206902 | 40,19€ |
| T.6 | 1 | 206901 | 40,19€ |



Veste mixte Benak MC S



Cette veste ajustée en 37,5® est facile et légère à porter. Elle contient de la maille 37,5® pour plus de confort. Sa technologie 37,5® permet de réguler la température du corps. - Col officier - Apport de maille 37,5® sous les bras et sur le col - Fermeture boutons pression cachés - Poche stylo sur manche - Apport d'un liseré fantaisie contrasté

| Taille | | ○ Blanc | ● Noir | P.U |
|--------|---|---------|--------|--------|
| T.0 | 1 | 107954 | 107989 | 47,19€ |
| T.1 | 1 | 107955 | 107990 | 47,19€ |
| T.2 | 1 | 107956 | 107991 | 47,19€ |
| T.3 | 1 | 107957 | 107992 | 47,19€ |
| T.4 | 1 | 107958 | 107993 | 47,19€ |
| T.5 | 1 | 107959 | 107994 | 47,19€ |
| T.6 | 1 | 107960 | 107995 | 47,19€ |



Veste manches longues mixte Nero
Veste manches longues, polycoton. Boutons pressions cachés, poche poitrine intérieure, poche stylo sur manche,

| Taille | | ● Noir | ○ Blanc | ● Anthracite | P.U |
|--------|---|---------------|---------------|---------------|---------------|
| T.0 | 1 | 364540 | 206186 | 206193 | 29,08€ |
| T.1 | 1 | 364541 | 206187 | 206194 | 29,08€ |
| T.2 | 1 | 364542 | 206188 | 206195 | 29,08€ |
| T.3 | 1 | 364543 | 206189 | 206196 | 29,08€ |
| T.4 | 1 | 364544 | 206190 | 206197 | 29,08€ |
| T.5 | 1 | 364545 | 206191 | 206198 | 29,08€ |
| T.6 | 1 | 364546 | 206192 | 206199 | 29,08€ |



Veste mixte Nero manches courtes

Veste manches courtes, polycoton. Boutons pression cachés, poche poitrine intérieure, poche stylo sur manche

| Taille | | ● Noir | ● Vert | ● Bleu | ● Fuchsia | ● Melon | ● Anthracite | ○ Blanc | ● Bordeaux | ● Moka | ● Prune | ● Kaki | P.U |
|--------|---|---------------|---------------|---------------|---------------|---------------|---------------|---------------|---------------|---------------|---------------|---------------|---------------|
| T.0 | 1 | 201541 | 364748 | 364755 | 364762 | 364769 | 364776 | 364816 | 364859 | 364866 | 210740 | 210747 | 29,08€ |
| T.1 | 1 | 201542 | 364749 | 364756 | 364763 | 364770 | 364777 | 364817 | 364860 | 364867 | 210739 | 210746 | 29,08€ |
| T.2 | 1 | 201543 | 364750 | 364757 | 364764 | 364771 | 364778 | 364818 | 364861 | 364868 | 210738 | 210745 | 29,08€ |
| T.3 | 1 | 201544 | 364751 | 364758 | 364765 | 364772 | 364779 | 364819 | 364862 | 364869 | 210737 | 210744 | 29,08€ |
| T.4 | 1 | 201545 | 364752 | 364759 | 364766 | 364773 | 364780 | 364820 | 364863 | 364870 | 210736 | 210743 | 29,08€ |
| T.5 | 1 | 201546 | 364753 | 364760 | 364767 | 364774 | 364781 | 364821 | 364864 | 364871 | 210735 | 210742 | 29,08€ |
| T.6 | 1 | 201547 | 364754 | 364761 | 364768 | 364775 | 364782 | 364822 | 364865 | 364872 | 210734 | 210741 | 29,08€ |



Gilet matelassé unisexe Ulisse

Le gilet mixte anti-froid saura vous donner un confort optimal notamment grâce à son col officier et à son dos matelassé. Polycoton.

| Taille | | ● Marine | | ○ Blanc | |
|--------|---|----------|--------|---------|--------|
| | | | P.U | | P.U |
| S | 1 | 210989 | 29,15€ | 363406 | 29,94€ |
| M | 1 | 210990 | 29,15€ | 363407 | 29,94€ |
| L | 1 | 210991 | 29,15€ | 363408 | 29,94€ |
| XL | 1 | 210992 | 29,15€ | 363409 | 29,94€ |
| XXL | 1 | 210993 | 29,15€ | 363410 | 29,94€ |
| XXXL | 1 | 210994 | 29,15€ | 201526 | 29,94€ |



Veste mixte manches longues Abax

Col officier de couleur, devant fermé par boutons-pression cachés, devant et poche poitrine avec liseré de couleur, découpes épaules avec surpiqûre de couleur, manches longues finies par poignets intérieur de couleur, poche stylo sur manche gauche au porter, découpe côté en maille, découpe carrure dos avec 2 piqûres de couleur, 65% polyester, 35% coton,

| Taille | | ● Blanc / Noir | | ● Blanc / Denim | |
|--------|---|----------------|--------|-----------------|--------|
| | | | P.U | | P.U |
| T.00 | 1 | 364887 | 33,93€ | 364895 | 33,93€ |
| T.0 | 1 | 364888 | 33,93€ | 364896 | 33,93€ |
| T.1 | 1 | 364889 | 33,93€ | 364897 | 33,93€ |
| T.2 | 1 | 364890 | 33,93€ | 364898 | 33,93€ |
| T.3 | 1 | 364891 | 33,93€ | 364899 | 33,93€ |
| T.4 | 1 | 364892 | 33,93€ | 364900 | 33,93€ |
| T.5 | 1 | 364893 | 33,93€ | 364901 | 33,93€ |
| T.6 | 1 | 364894 | 33,93€ | 364902 | 33,93€ |



Gamme Cookie



Veste mixte manches courtes

1 poche stylo, pressions cachées, H 72 cm, 65% polyester / 35% coton

| Taille | Quantité | Blanc | | Noir | | Rouge | | Bleu gitane | | Bleu marine | | Orange | | Gris nimbus | | P.U |
|--------|----------|--------|--------|--------|--------|--------|--------|-------------|--------|-------------|--------|--------|--------|-------------|--|-----|
| | | Code | P.U | Code | P.U | Code | P.U | Code | P.U | Code | P.U | Code | P.U | | | |
| T.0 | 1 | 205546 | 14,95€ | 210769 | 18,93€ | 205483 | 205560 | 205553 | 210776 | 205476 | 205469 | 205476 | 205469 | 20,52€ | | |
| T.1 | 1 | 205547 | 14,95€ | 210770 | 18,93€ | 205484 | 205561 | 205554 | 210777 | 205477 | 205470 | 205477 | 205470 | 20,52€ | | |
| T.2 | 1 | 205548 | 14,95€ | 210771 | 18,93€ | 205485 | 205562 | 205555 | 210778 | 205478 | 205471 | 205478 | 205471 | 20,52€ | | |
| T.3 | 1 | 205549 | 14,95€ | 210772 | 18,93€ | 205486 | 205563 | 205556 | 210779 | 205479 | 205472 | 205479 | 205472 | 20,52€ | | |
| T.4 | 1 | 205550 | 14,95€ | 210773 | 18,93€ | 205487 | 205564 | 205557 | 210780 | 205480 | 205473 | 205480 | 205473 | 20,52€ | | |
| T.5 | 1 | 205551 | 14,95€ | 210774 | 18,93€ | 205488 | 205565 | 205558 | 210781 | 205481 | 205474 | 205481 | 205474 | 20,52€ | | |
| T.6 | 1 | 205552 | 14,95€ | 210775 | 18,93€ | 205489 | 205566 | 205559 | 210782 | 205482 | 205475 | 205482 | 205475 | 20,52€ | | |



Veste mixte manches longues

1 poche stylo, pressions cachées, H 72 cm, 65% polyester / 35% coton

| Taille | Quantité | Blanc | | Noir | | Rouge | | Bleu gitane | | Bleu marine | | Orange | | Pistache | | Gris nimbus | | P.U |
|--------|----------|--------|--------|--------|--------|--------|--------|-------------|--------|-------------|--------|--------|--------|----------|--------|-------------|--|-----|
| | | Code | P.U | Code | P.U | Code | P.U | Code | P.U | Code | P.U | Code | P.U | Code | P.U | | | |
| T.0 | 1 | 205567 | 18,45€ | 210797 | 18,45€ | 205504 | 205574 | 205581 | 23,70€ | 205497 | 205511 | 205490 | 205497 | 205511 | 205490 | 23,70€ | | |
| T.1 | 1 | 205568 | 18,45€ | 210798 | 18,45€ | 205505 | 205575 | 205582 | 23,70€ | 205498 | 205512 | 205491 | 205498 | 205512 | 205491 | 23,70€ | | |
| T.2 | 1 | 205569 | 18,45€ | 210799 | 18,45€ | 205506 | 205576 | 205583 | 23,70€ | 205499 | 205513 | 205492 | 205499 | 205513 | 205492 | 23,70€ | | |
| T.3 | 1 | 205570 | 18,45€ | 210800 | 18,45€ | 205507 | 205577 | 205584 | 23,70€ | 205500 | 205514 | 205493 | 205500 | 205514 | 205493 | 23,70€ | | |
| T.4 | 1 | 205571 | 18,45€ | 210801 | 18,45€ | 205508 | 205578 | 205585 | 23,70€ | 205501 | 205515 | 205494 | 205501 | 205515 | 205494 | 23,70€ | | |
| T.5 | 1 | 205572 | 18,45€ | 210802 | 18,45€ | 205509 | 205579 | 205586 | 23,70€ | 205502 | 205516 | 205495 | 205502 | 205516 | 205495 | 23,70€ | | |
| T.6 | 1 | 205573 | 18,45€ | 210803 | 18,45€ | 205510 | 205580 | 205587 | 23,70€ | 205503 | 205517 | 205496 | 205503 | 205517 | 205496 | 23,70€ | | |



Pantalon mixte Blino

Ceinture fermée par un bouton clou, passants à la ceinture, braguette fermée par zip, poches italiennes, une poche arrière côté droit au porter, empiècement dos, bas de jambes finis par ourlets, composition: 49% polyester 49% coton 2% élasthanne

| Taille | 📦 | ● Noir | P.U |
|--------|---|---------------|---------------|
| T.34 | 1 | 205443 | 38,15€ |
| T.36 | 1 | 205444 | 38,15€ |
| T.62 | 1 | 205445 | 38,15€ |
| T.38 | 1 | 205446 | 38,15€ |
| T.40 | 1 | 205447 | 38,15€ |
| T.42 | 1 | 205448 | 38,15€ |
| T.44 | 1 | 205449 | 38,15€ |
| T.46 | 1 | 205450 | 38,15€ |
| T.48 | 1 | 205451 | 38,15€ |
| T.50 | 1 | 205452 | 38,15€ |
| T.52 | 1 | 205453 | 38,15€ |
| T.56 | 1 | 205454 | 38,15€ |
| T.58 | 1 | 205455 | 38,15€ |



Pantalon mixte Archet S

Ceinture élastiquée et recouverte d'éponge, fermeture à glissière, poches cavalières, poche passepoilée dos, ourlets bas de jambes, coupe slim

| Taille | 📦 | ● Anthracite | ● Noir | P.U |
|--------|---|-----------------|---------------|---------------|
| T.0 | 1 | 205396 | 205410 | 52,01€ |
| T.1 | 1 | 205397 | 205411 | 52,01€ |
| T.2 | 1 | 205398 | 205412 | 52,01€ |
| T.3 | 1 | 205399 | 205413 | 52,01€ |
| T.4 | 1 | 205400 | 205414 | 52,01€ |
| T.5 | 1 | 205401 | 205415 | 52,01€ |
| T.6 | 1 | 205402 | 205416 | 52,01€ |



Pantalon mixte Umini

Pantalon avec taille élastiquée. Poches coutures côtés. Bas de jambes réglables par boutons-pression, 65% Polyester 35% Coton. Existe aussi en Pied de poule.

| Taille | 📦 | ● Anthracite | | ○ Blanc | | ● Noir | |
|--------|---|--------------|--------|---------|--------|--------|--------|
| | | P.U | P.U | P.U | P.U | | |
| T.0 | 1 | 210995 | 21,31€ | 201602 | 21,16€ | 201609 | 21,92€ |
| T.1 | 1 | 210996 | 21,31€ | 201603 | 21,16€ | 201610 | 21,92€ |
| T.2 | 1 | 210997 | 21,31€ | 201604 | 21,16€ | 201611 | 21,92€ |
| T.3 | 1 | 210998 | 21,31€ | 201605 | 21,16€ | 201612 | 21,92€ |
| T.4 | 1 | 210999 | 21,31€ | 201606 | 21,16€ | 201613 | 21,92€ |
| T.5 | 1 | 211000 | 21,31€ | 201607 | 21,16€ | 201614 | 21,92€ |
| T.6 | 1 | 211001 | 21,31€ | 201608 | 21,16€ | 201615 | 21,92€ |



Pantalon mixte Timéo

Ceinture élastique côtés + bouton clou. Braguette fermée par boutons pression. Poches italiennes. Poche dos plaquée. Pinces dos. Polycoton : 65 % polyester, 35 % coton.

| Taille | 📦 | ● Anthracite | | ● Denim | | ● Noir | |
|--------|---|--------------|--------|---------|--------|--------|--------|
| | | P.U | P.U | P.U | P.U | | |
| T.36 | 1 | 212426 | 29,15€ | 212438 | 32,65€ | 364140 | 30,19€ |
| T.38 | 1 | 212427 | 29,15€ | 212439 | 32,65€ | 364141 | 30,19€ |
| T.40 | 1 | 212428 | 29,15€ | 212440 | 32,65€ | 364142 | 30,19€ |
| T.42 | 1 | 212429 | 29,15€ | 212441 | 32,65€ | 364143 | 30,19€ |
| T.44 | 1 | 212430 | 29,15€ | 212442 | 32,65€ | 364144 | 30,19€ |
| T.46 | 1 | 212431 | 29,15€ | 212443 | 32,65€ | 364145 | 30,19€ |
| T.48 | 1 | 212432 | 29,15€ | 212444 | 32,65€ | 364146 | 30,19€ |
| T.50 | 1 | 212433 | 29,15€ | 212445 | 32,65€ | 364147 | 30,19€ |
| T.52 | 1 | 212434 | 29,15€ | 212446 | 32,65€ | 364148 | 30,19€ |
| T.54 | 1 | 212435 | 29,15€ | 212447 | 32,65€ | 364149 | 30,19€ |
| T.56 | 1 | 212436 | 29,15€ | 212448 | 32,65€ | 364150 | 30,19€ |
| T.58 | 1 | 212437 | 29,15€ | 212449 | 32,65€ | 364151 | 30,19€ |



Pantalon Hervé pied de poule
2 poches italiennes + 1 poche dos. Braguette glissière + 1 bouton.
Ceinture élastique côté Poly/coton pied de poule

| Taille | 📦 | Coton | P.U | Poly/Coton | P.U |
|--------|---|--------|--------|------------|--------|
| T.36 | 1 | 205641 | 14,95€ | 205626 | 17,82€ |
| T.38 | 1 | 205642 | 14,95€ | 205627 | 17,82€ |
| T.40 | 1 | 205643 | 14,95€ | 205628 | 17,82€ |
| T.42 | 1 | 205644 | 14,95€ | 205629 | 17,82€ |
| T.44 | 1 | 205645 | 14,95€ | 205630 | 17,82€ |
| T.46 | 1 | 205646 | 14,95€ | 205631 | 17,82€ |
| T.48 | 1 | 205647 | 14,95€ | 205632 | 17,82€ |
| T.50 | 1 | 205648 | 14,95€ | 205633 | 17,82€ |
| T.52 | 1 | 205649 | 14,95€ | 205634 | 17,82€ |
| T.54 | 1 | 205650 | 14,95€ | 205635 | 17,82€ |
| T.56 | 1 | 205651 | 14,95€ | 205636 | 17,82€ |
| T.58 | 1 | 205652 | 14,95€ | 205637 | 17,82€ |
| T.60 | 1 | 205653 | 14,95€ | 205638 | 17,82€ |
| T.62 | 1 | 205654 | 14,95€ | 205639 | 17,82€ |
| T.64 | 1 | 205655 | 14,95€ | 205640 | 17,82€ |



Pantalon mixte André
Taille élastiquée - Entrejambe : 80 cm - 65% Polyester / 35% Coton

| Taille | 📦 | ● Bleu marine | P.U | ○ Blanc | P.U | ● Noir | P.U | ● Fuschia | ● Gris nimbus | ● Pistache | ● Taupe | P.U |
|--------|---|---------------|--------|---------|--------|--------|--------|-----------|---------------|------------|---------|--------|
| T.0 | 1 | 210846 | 17,02€ | 210818 | 12,10€ | 210825 | 17,02€ | 210860 | 210895 | 210902 | 210923 | 17,02€ |
| T.1 | 1 | 210847 | 17,02€ | 210819 | 12,10€ | 210826 | 17,02€ | 210861 | 210896 | 210903 | 210924 | 17,02€ |
| T.2 | 1 | 210848 | 17,02€ | 210820 | 12,10€ | 210827 | 17,02€ | 210862 | 210897 | 210904 | 210925 | 17,02€ |
| T.3 | 1 | 210849 | 17,02€ | 210821 | 12,10€ | 210828 | 17,02€ | 210863 | 210898 | 210905 | 210926 | 17,02€ |
| T.4 | 1 | 210850 | 17,02€ | 210822 | 12,10€ | 210829 | 17,02€ | 210864 | 210899 | 210906 | 210927 | 17,02€ |
| T.5 | 1 | 210851 | 17,02€ | 210823 | 12,10€ | 210830 | 17,02€ | 210865 | 210900 | 210907 | 210928 | 17,02€ |
| T.6 | 1 | 210852 | 17,02€ | 210824 | 12,10€ | 210831 | 17,02€ | 210866 | 210901 | 210908 | 210929 | 17,02€ |

MOCASSINS DE SÉCURITÉ

SOPHIE NEW

Cette chaussure de Sécurité Cuisine résiste à toutes les chutes d'ustensiles. Le col de confort à l'arrière génère bien-être et soutien autour de la cheville. Embout de sécurité : acier.



| Taille | Blanc | P.U |
|--------|----------|--------|
| T.34 | 1 204817 | 53,35€ |
| T.35 | 1 204816 | 53,35€ |
| T.36 | 1 204815 | 53,35€ |
| T.37 | 1 204814 | 53,35€ |
| T.38 | 1 204813 | 53,35€ |
| T.39 | 1 204812 | 53,35€ |
| T.40 | 1 204811 | 53,35€ |
| T.41 | 1 204810 | 53,35€ |
| T.42 | 1 204809 | 53,35€ |

TED

Parfaitement adapté aux milieux de l'Agro-alimentaire et de la Restauration. Confortable et 100% Sécurité, ce modèle est très facile d'entretien. Embout de sécurité : acier. Languette ajustable par velcro,



| Taille | Blanc | Noir | P.U |
|--------|----------|--------|--------|
| T.35 | 1 204782 | 204781 | 37,62€ |
| T.36 | 1 204780 | 204779 | 37,62€ |
| T.37 | 1 204778 | 204777 | 37,62€ |
| T.38 | 1 204776 | 204775 | 37,62€ |
| T.39 | 1 204774 | 204773 | 37,62€ |
| T.40 | 1 204772 | 204771 | 37,62€ |
| T.41 | 1 204770 | 204769 | 37,62€ |
| T.42 | 1 204768 | 204767 | 37,62€ |
| T.43 | 1 204766 | 204765 | 37,62€ |
| T.44 | 1 204764 | 204763 | 37,62€ |
| T.45 | 1 204762 | 204761 | 37,62€ |
| T.46 | 1 204760 | 204759 | 37,62€ |
| T.47 | 1 204758 | 204757 | 37,62€ |
| T.48 | 1 204756 | 204755 | 37,62€ |

TONY

Cette chaussure de sécurité alimentaire apporte protection et confort, grâce à sa coquille en acier et une semelle antidérapante. Confortable et pratique grâce à sa doublure textile souple et respirante, facile d'entretien. Embout de sécurité : acier.



| Taille | Blanc | Noir | P.U |
|--------|----------|--------|--------|
| T.35 | 1 - | 204844 | 30,63€ |
| T.36 | 1 204843 | 204842 | 30,63€ |
| T.37 | 1 204841 | 204840 | 30,63€ |
| T.38 | 1 204839 | 204838 | 30,63€ |
| T.39 | 1 204837 | 204836 | 30,63€ |
| T.40 | 1 204835 | 204834 | 30,63€ |
| T.41 | 1 204833 | 204832 | 30,63€ |
| T.42 | 1 204831 | 204830 | 30,63€ |
| T.43 | 1 204829 | 204828 | 30,63€ |
| T.44 | 1 204827 | 204826 | 30,63€ |
| T.45 | 1 204825 | 204824 | 30,63€ |
| T.46 | 1 204823 | 204822 | 30,63€ |
| T.47 | 1 204821 | 204820 | 30,63€ |
| T.48 | 1 204819 | 204818 | 30,63€ |

DAN

Mocassin sécurité en microfibre normé EN ISO 20345 S3, il sera facile d'entretien. Sa semelle extérieure est normée SRC pour une bonne adhérence. Sa coque en composite et l'intercalaire anti-perforation en textile composite le rendent plus léger pour une bonne sécurité. Idéal pour les métiers de bouches, agroalimentaire, restauration, Industrie. Hygiène & Collectivité.



| Taille | Noir | Blanc | P.U |
|--------|----------|--------|--------|
| T.36 | 1 206908 | 206921 | 54,51€ |
| T.37 | 1 206909 | 206922 | 54,51€ |
| T.38 | 1 206910 | 206923 | 54,51€ |
| T.39 | 1 206911 | 206924 | 54,51€ |
| T.40 | 1 206912 | 206925 | 54,51€ |
| T.41 | 1 206913 | 206926 | 54,51€ |
| T.42 | 1 206914 | 206927 | 54,51€ |
| T.43 | 1 206915 | 206928 | 54,51€ |
| T.44 | 1 206916 | 206929 | 54,51€ |
| T.45 | 1 206917 | 206930 | 54,51€ |
| T.46 | 1 206918 | 206931 | 54,51€ |
| T.47 | 1 206919 | 206932 | 54,51€ |
| T.48 | 1 206920 | 206933 | 54,51€ |

BRICE PLUS

Très résistantes et fabriquées en microfibres, les chaussures de sécurité Brice PLUS sont respirantes, souples et lavables facilement. Avec son embout de sécurité en composite, sa nouvelle semelle REFLEX intégrée et sa nouvelle doublure mesh+, ce modèle de moccasin de sécurité apporte confort et maintien du pied.



| Taille | Blanc | Noir | P.U |
|--------|----------|--------|--------|
| T.35 | 1 204808 | 204807 | 56,99€ |
| T.36 | 1 204806 | 204805 | 56,99€ |
| T.37 | 1 204804 | 204803 | 56,99€ |
| T.38 | 1 204802 | 204801 | 56,99€ |
| T.39 | 1 204800 | 204799 | 56,99€ |
| T.40 | 1 204798 | 204797 | 56,99€ |
| T.41 | 1 204796 | 204795 | 56,99€ |
| T.42 | 1 204794 | 204793 | 56,99€ |
| T.43 | 1 204792 | 204791 | 56,99€ |
| T.44 | 1 204790 | 204789 | 56,99€ |
| T.45 | 1 204788 | 204787 | 56,99€ |
| T.46 | 1 204786 | 204785 | 56,99€ |
| T.47 | 1 204784 | 204783 | 56,99€ |

BOTTE DE SÉCURITÉ

OMEGA

Caoutchou nitrilique/PVC très bonne résistance aux graisses animales et végétales. Embout de sécurité : acier.



| Taille | Blanc | P.U |
|--------|----------|--------|
| T.36 | 1 205668 | 28,57€ |
| T.37 | 1 205667 | 28,57€ |
| T.38 | 1 205666 | 28,57€ |
| T.39 | 1 205665 | 28,57€ |
| T.40 | 1 205664 | 28,57€ |
| T.41 | 1 205663 | 28,57€ |
| T.42 | 1 205662 | 28,57€ |
| T.43 | 1 205661 | 28,57€ |
| T.44 | 1 205660 | 28,57€ |
| T.45 | 1 205659 | 28,57€ |
| T.46 | 1 205658 | 28,57€ |
| T.47 | 1 205657 | 28,57€ |
| T.48 | 1 205656 | 28,57€ |

SABOT DE SÉCURITÉ

SILVO

Sabot de sécurité tout confort, pour les métiers de l'agro-alimentaire et de la restauration. Equipé d'une microfibre hydrofuge, souple et respirante avec une semelle antidérapante ultra efficace. Embout de sécurité : acier



| Taille | ☒ | ○ Blanc | ● Noir | P.U |
|--------|---|---------|--------|--------|
| T.35 | 1 | 204929 | 204928 | 39,30€ |
| T.36 | 1 | 204927 | 204926 | 39,30€ |
| T.37 | 1 | 204925 | 204924 | 39,30€ |
| T.38 | 1 | 204923 | 204922 | 39,30€ |
| T.39 | 1 | 204921 | 204920 | 39,30€ |
| T.40 | 1 | 204919 | 204918 | 39,30€ |
| T.41 | 1 | 204917 | 204916 | 39,30€ |
| T.42 | 1 | 204915 | 204914 | 39,30€ |
| T.43 | 1 | 204913 | 204912 | 39,30€ |
| T.44 | 1 | 204911 | 204910 | 39,30€ |
| T.45 | 1 | 204909 | 204908 | 39,30€ |
| T.46 | 1 | 204907 | 204906 | 39,30€ |
| T.47 | 1 | 204905 | 204904 | 39,30€ |
| T.48 | 1 | 204903 | 204902 | 39,30€ |

THOR

Sabot de Sécurité mixte pour les métiers de l'agro-alimentaire et de la restauration. Equipé d'un cuir souple et respirant avec une semelle antidérapante ultra efficace. Embout de sécurité : acier



| Taille | ☒ | ● Noir | ○ Blanc | P.U |
|--------|---|--------|---------|--------|
| T.35 | 1 | 204956 | 204957 | 54,76€ |
| T.36 | 1 | 204954 | 204955 | 54,76€ |
| T.37 | 1 | 204952 | 204953 | 54,76€ |
| T.38 | 1 | 204950 | 204951 | 54,76€ |
| T.39 | 1 | 204948 | 204949 | 54,76€ |
| T.40 | 1 | 204946 | 204947 | 54,76€ |
| T.41 | 1 | 204944 | 204945 | 54,76€ |
| T.42 | 1 | 204942 | 204943 | 54,76€ |
| T.43 | 1 | 204940 | 204941 | 54,76€ |
| T.44 | 1 | 204938 | 204939 | 54,76€ |
| T.45 | 1 | 204936 | 204937 | 54,76€ |
| T.46 | 1 | 204934 | 204935 | 54,76€ |
| T.47 | 1 | 204932 | 204933 | 54,76€ |
| T.48 | 1 | 204930 | 204931 | 54,76€ |

NFORZ

Sabot de sécurité extrêmement léger par sa conception en EVA. Bon maintien du pied et possibilité de mettre en place une semelle orthopédique. Technologie EXTRA GRIP® garantie zéro glissade.



| Taille | ☒ | ○ Blanc | ● Fuchsia | ● Gris | ● Noir | P.U |
|--------|---|---------|-----------|--------|--------|--------|
| T.36 | 1 | 206060 | 206061 | 206062 | 206063 | 50,37€ |
| T.37 | 1 | 206064 | 206065 | 206066 | 206067 | 50,37€ |
| T.38 | 1 | 206068 | 206069 | 206070 | 206071 | 50,37€ |
| T.39 | 1 | 206072 | 206073 | 206074 | 206075 | 50,37€ |
| T.40 | 1 | 206076 | 206077 | 206078 | 206079 | 50,37€ |
| T.41 | 1 | 206080 | 206081 | 206082 | 206083 | 50,37€ |
| T.42 | 1 | 206084 | 206085 | 206086 | 206087 | 50,37€ |
| T.43 | 1 | 206088 | - | 206089 | 206090 | 50,37€ |
| T.44 | 1 | 206091 | - | 206092 | 206093 | 50,37€ |
| T.45 | 1 | 206094 | - | 206095 | 206096 | 50,37€ |
| T.46 | 1 | 206097 | - | 206098 | 206099 | 50,37€ |
| T.47 | 1 | 206100 | - | 206101 | 206102 | 50,37€ |

NFRESH

Chaussette en cool max ultra respirante. Adaptée pour les chaussures professionnelles, renforts à l'avant et au talon pour une plus longue durée de vie. Liseré de couleur en fonction de la peinture pour faciliter le lavage industriel. Bord ôte large pour éviter la compression de la cheville. COMMANDE par 10 paires à la peinture/colors



| Taille | ☒ | ○ Blanc | ● Noir | P.U |
|--------|----|---------|--------|-------|
| 36-38 | 5 | 206934 | 206935 | 8,97€ |
| 39-41 | 10 | 206936 | 206937 | 8,97€ |
| 42-44 | 10 | 206938 | 206939 | 8,97€ |
| 45-47 | 10 | 206940 | 206941 | 8,97€ |
| 48-50 | 5 | 206942 | 206943 | 8,97€ |

TEXTILE

Chaussures

CHAUSSURE DE SÉCURITÉ SPORT

RUN CLASSIC

Basket de sécurité homme en microfibre lisse et perforée apporte un grand confort. Equipée d'une coque de protection et d'une semelle anti-perforation. Utilisation idéale pour le service, la restauration, la distribution, etc. Embout de sécurité : composite.



| Taille | ☒ | ● Noir | ○ Blanc | P.U |
|--------|---|--------|---------|--------|
| T.36 | 1 | 204978 | | 83,27€ |
| T.37 | 1 | 204977 | | 83,27€ |
| T.38 | 1 | 204975 | 204976 | 83,27€ |
| T.39 | 1 | 204973 | 204974 | 83,27€ |
| T.40 | 1 | 204971 | 204972 | 83,27€ |
| T.41 | 1 | 204969 | 204970 | 83,27€ |
| T.42 | 1 | 204967 | 204968 | 83,27€ |
| T.43 | 1 | 204965 | 204966 | 83,27€ |
| T.44 | 1 | 204963 | 204964 | 83,27€ |
| T.45 | 1 | 204961 | 204962 | 83,27€ |
| T.46 | 1 | 204959 | 204960 | 83,27€ |
| T.47 | 1 | 204958 | | 83,27€ |

CHAUSSURE DE SÉCURITÉ

BERND NEW

Une Chaussure de Sécurité Haute pour l'industrie alimentaire qui apporte un vrai Confort et de la Stabilité. Le haut de tige qui couvre les malléoles le rend ultra confortable et permet un bon maintien de la cheville. Stabilité. Confort et Sécurité définissent le modèle Bernd. Embout de sécurité : composite.



| Taille | ☒ | ○ Blanc | P.U |
|--------|---|---------|--------|
| T.35 | 1 | 206041 | 40,83€ |
| T.36 | 1 | 206042 | 40,83€ |
| T.37 | 1 | 206043 | 40,83€ |
| T.38 | 1 | 206044 | 40,83€ |
| T.39 | 1 | 206045 | 40,83€ |
| T.40 | 1 | 206046 | 40,83€ |
| T.41 | 1 | 206047 | 40,83€ |
| T.42 | 1 | 206048 | 40,83€ |
| T.43 | 1 | 206049 | 40,83€ |
| T.44 | 1 | 206050 | 40,83€ |
| T.45 | 1 | 206051 | 40,83€ |
| T.46 | 1 | 206052 | 40,83€ |
| T.47 | 1 | 206053 | 40,83€ |

LA VAISSELLE

Tendance & Décor

FEELING

'D'inspiration naturelle et sur une base de forme coupe simple et pure, superbe collection de grès émaillé réactif sur la surface intérieure des pièces. De lumineux coloris réhaussés d'une bordure marron viennent habiller avec élégance la gamme. FEELING se décline en 4 coloris : Bronze, Jade, Indigo et Turquoise.



| Dimension | Quantité | Bronze | Indigo | Jade | Turquoise | P.U |
|--------------------------|----------|--------|--------|--------|-----------|--------|
| Ø 26,5 cm - Plate | 1 | 100211 | 100216 | 100205 | 100160 | 6,41€ |
| Ø 24,5 cm - Gourmet | 1 | 114590 | 114591 | - | - | 12,07€ |
| Ø 21 cm - Dessert | 1 | 100212 | 100217 | 100206 | 100161 | 6,00€ |
| Ø 18 cm - Salade & Pâtes | 1 | 100213 | 100218 | 100207 | 100162 | 6,41€ |
| 45 cl - Bol | 1 | 100214 | 100219 | 100208 | 100163 | 5,72€ |



SHADOW

'Magnifique et lumineuse collection de grès réactif émaillé à l'arrondi irrégulier. Rehaussée d'un extérieur grainé de gris anthracite et d'un intérieur nacré pour créer un contraste vivifiant.



| Dimension | Quantité | P.U., |
|------------------------------|----------|---------------|
| Ø 28 cm - Plate | 1 | 100195 7,07€ |
| Ø 19,5 cm - Gourmet | 1 | 100203 7,34€ |
| Ø 20,5 cm - Dessert | 1 | 100196 6,67€ |
| 45 cl - Bol déjeuner | 1 | 100197 5,60€ |
| 30 cl - Mug | 1 | 100198 5,60€ |
| Ø 24 cm - Saladier | 1 | 100204 17,45€ |
| Ø 15,2 cm - 30 cl - Coupelle | 1 | 100202 5,06€ |
| Ø 12 cm - 15 cl - Coupelle | 1 | 100201 4,38€ |
| 35,5 x 14 cm - Plat long | 1 | 100199 16,77€ |
| 23 x 11 cm - Plat long | 1 | 100200 8,03€ |

YAKA

'Un design pur et raffiné pour cette gamme multi-usage. Porcelaine fine au blanc pur et à la silhouette tout en rondeur.



| Dimension | Quantité | P.U |
|--------------------------|----------|---------------|
| Ø 27 cm - Plate | 1 | 100184 6,41€ |
| Ø 21,5 cm - Dessert | 1 | 100185 6€ |
| Ø 20 cm - Salade & Pâtes | 1 | 100186 6,41€ |
| 50 cl - Bol déjeuner | 1 | 100193 6,41€ |
| 40 cl - Mug | 1 | 100192 6,67€ |
| 20 cl - Tasse à thé | 1 | 100191 4,91€ |
| Ø 25 cm - Saladier | 1 | 100194 26,28€ |

LA VAISSELLE

Tendance & Décor

Nouveauté

FLOW

'La collection FLOW se compose des essentiels de la table. Les formes sont simples et pures ; elles sont soulignées d'élégantes gravures concentriques qui habillent les pièces. La collection est déclinée dans 3 coloris minéraux qui nous parlent de pierre et de terre.



| Dimension | Quantité | Sable | Granit | Gris | P.U |
|--------------------------|----------|---------------|---------------|---------------|--------------|
| Ø 27 cm - Plate | 1 | 115662 | 115667 | 115672 | 7,07€ |
| Ø 21,5 cm - Dessert | 1 | 115663 | 115668 | 115673 | 6,67€ |
| Ø 18 cm - Salade & Pâtes | 1 | 115664 | 115669 | 115674 | 7,07€ |
| Ø 22 cm - Gourmet | 1 | 115665 | 115670 | 115675 | 9,76€ |
| 35 cl - Mug | 1 | 115666 | 115671 | 115676 | 5,60€ |

ESCALE & ONDE

'La collection ESCALE en grès noir mat et la collection ONDE en porcelaine émaillée blanche, possèdent une forme avec gravure en relief sur une forme ronde à aile large très actuelle. Elles s'associent pour créer une table graphique contrastée avec un mélange de noir et de blanc.



| Dimension | Quantité | Noir | P.U | Blanc | P.U |
|----------------------------------|----------|---------------|---------------|---------------|---------------|
| Ø 31,5 cm - Présentation | 1 | 124157 | 16,88€ | 100165 | 17,96€ |
| Ø 27,5 cm - Plate | 1 | 124158 | 9,01€ | 100173 | 9,32€ |
| Ø 21,5 cm - Dessert | 1 | 124161 | 8,47€ | 100176 | 8,72€ |
| Ø 22,5 cm - Creuse à aile | 1 | 124159 | 9,01€ | 100174 | 9,32€ |
| Ø 28 cm - Assiette à pâtes | 1 | 124160 | 16,88€ | - | - |
| 11 cl - Tasse café et sous tasse | 1 | 124162 | 9,56€ | - | - |
| Ø 15,5 cm - Assiette à pain | 1 | - | - | 100177 | 5,95€ |

LA VAISSELLE

Tendance & Décor

ASTER 'Une collection au design contemporain. Réalisée sur une base de forme arrondie, les bordures sont relevées et soulignées d'un élégant filet blanc.
Grès réactif noir effet mat/brillant. Les aspérités mates/brillantes sont formées par l'émail qui réagit à la chaleur du four.



| Dimension | Quantité | Code | P.U. |
|--------------------------|----------|--------|-------|
| Ø 26 cm - Plate | 6 | 114553 | 7,07€ |
| Ø 21 cm - Dessert | 6 | 114554 | 6,67€ |
| Ø 17 cm - Salade & pâtes | 6 | 114556 | 7,07€ |

VERTIGO

'Vertigo incarne l'authenticité et la chaleur nées de lignes organiques et de matériaux naturels. Cette collection aux contours irréguliers reprend l'aspect de la pierre, sa texture, ses contours asymétriques. Gamme fonctionnelle et résistante. Grès / Emaux réactifs gris, effet pierreux.



| Dimension | Quantité | Code | P.U. |
|----------------------------|----------|--------|-------|
| Ø 27 cm - Plate | 1 | 114545 | 7,07€ |
| Ø 21 cm - Dessert | 1 | 114546 | 6,67€ |
| Ø 20,5 cm - Salade & pâtes | 1 | 114547 | 7,07€ |
| Ø 15,5 cm - Bol déjeuner | 1 | 114551 | 5,60€ |
| 32 cl - Mug | 1 | 114552 | 5,60€ |

HYPNOSE

'Trois assiettes décorées sur une base de forme coupe que l'on associe aux buvants (bol et mug) de la gamme magma noir. Pour une table graphique et contemporaine, les assiettes bordurées d'un filet noir mettent en valeur un décor à l'effet rayonnant qui apporte du caractère à la table. Grès.



| Dimension | Quantité | Code | P.U. |
|----------------------------|----------|--------|-------|
| Ø 27 cm - Plate | 1 | 103469 | 6,41€ |
| Ø 20,5 cm - Dessert | 1 | 103470 | 6,00€ |
| Ø 18,5 cm - Salade & pâtes | 1 | 103471 | 6,41€ |

LA VAISSELLE

Tendance & Décor

BAGHERA

'Une ligne de porcelaine fine décorée d'un subtil motif texturé pour une table urbaine et stylée. Des assiettes contemporaines aux ailes planes et larges très actuelles mettent en valeur ce décor moderne. Un décor chic et contemporain décliné en deux variantes couleur : platine ou blanc, que l'on peut alterner sur la table pour un résultat encore plus graphique. A noter : les tasses café et thé sont blanches. Porcelaine. On vient les associer à des soucoupes décorées.



| Dimension | | Platine | Blanc | P.U. |
|------------------------------------|---|---------------|---------------|---------------|
| Ø 29 cm - Présentation | 6 | 103463 | 103457 | 12,47€ |
| Ø 27 cm - Plate | 6 | 103464 | 103458 | 6,94€ |
| Ø 23 cm - Dessert | 6 | 103465 | 103459 | 6,67€ |
| Ø 23 cm - Creuse à aile | 6 | 103466 | 103460 | 6,94€ |
| Ø 22 cl - Tasse et Sous-tasse thé | 6 | 103468 | 103462 | 7,34€ |
| Ø 12 cl - Tasse et Sous-tasse café | 6 | 103467 | 103461 | 6,67€ |



LA VAISSELLE

Tendance & Décor

EMMA

'Avec son design minimaliste et épuré, cette collection en porcelaine s'adapte parfaitement avec les autres éléments de votre vaisselle.



| Dimension | Q | | P.U. |
|---------------------------|----|---------------|---------------|
| Ø 30,5 cm - Présentation | 2 | 115677 | 11,48€ |
| Ø 26,5 cm - Plate | 6 | 115678 | 4,98€ |
| Ø 21 cm - Creuse | 6 | 115679 | 4,98€ |
| Ø 21 cm - Dessert | 6 | 115680 | 4,91€ |
| Ø 23 cm - Saladier | 3 | 115684 | 13,97€ |
| Ø 18 cm - Saladier | 4 | 115683 | 7,40€ |
| Ø 14 cm - Coupelle | 6 | 115682 | 3,55€ |
| Ø 11,5 cm - Coupelle | 12 | 115681 | 2,64€ |
| Ø 15 cm - Assiette à pain | 6 | 115691 | 2,42€ |
| 0,85 L - Théière | 1 | 115690 | 15,86€ |
| 32 cl - Mug | 6 | 115688 | 3,78€ |
| 20 cl - Tasse à thé | 6 | 115687 | 4,98€ |
| 10 cl - Tasse à café | 6 | 115686 | 3,32€ |
| Ø 9,5 cm - Sucrier | 4 | 115689 | 6,49€ |
| 30 x 20 cm - Plat ovale | 4 | 115685 | 9,21€ |

ZEN

'Simplicité et élégance pour ces assiettes de la collection Zen, qui sauront s'adapter à toutes les circonstances. En porcelaine blanche.



| Dimension | Q | | P.U. |
|-------------------|---|---------------|--------------|
| Ø 27 cm - Plate | 6 | 115692 | 3,47€ |
| Ø 23 cm - Creuse | 6 | 115694 | 3,47€ |
| Ø 23 cm - Dessert | 6 | 115695 | 3,25€ |
| Ø 20 cm - Calotte | 6 | 115693 | 3,40€ |

ONYX

'Collection qui marie avec élégance la robustesse du grès à des nuances envoûtantes et chaleureuses de marron et de noir.



| Dimension | Q | | P.U. |
|----------------------------|---|---------------|--------------|
| Ø 27 cm - Plate | 6 | 115696 | 5,44€ |
| Ø 21 cm - Dessert | 6 | 115698 | 5,29€ |
| Ø 22 cm - Calotte | 6 | 115697 | 5,44€ |
| Ø 27 cm - Assiette à pâtes | 4 | 115701 | 8,91€ |
| Ø 24 cm - Saladier | 4 | 115699 | 9,82€ |
| Ø 17 cm - Coupelle | 6 | 115700 | 5,44€ |



LA VAISSELLE

Tendance & Décor

SELENA

'Finesse des formes et pureté du blanc lumineux, une collection en porcelaine renforcée, très élégante et contemporaine.



| Dimension | ☛ | P.U. |
|---------------------------|----|----------------------|
| Ø 26,5 cm - Plate | 6 | 114419 5,72€ |
| Ø 21,5 cm - Dessert | 6 | 114421 5,29€ |
| Ø 21,5 cm - Calotte | 6 | 114420 5,29€ |
| Ø 18 cm - Saladier | 4 | 114423 7,72€ |
| Ø 20,5 cm - Saladier haut | 4 | 114425 10,22€ |
| Ø 18 cm - Saladier haut | 6 | 114424 7,72€ |
| Ø 15 cm - Assiette à pain | 6 | 114422 2,69€ |
| Ø 15 cm - Grand bol | 6 | 114426 4,25€ |
| Ø 12,5 cm - Bol | 6 | 114427 3,03€ |
| Ø 10 cm - Bol | 12 | 114428 2,08€ |



LOUNA

Finesse des formes et pureté du blanc lumineux, une collection en porcelaine renforcée, très élégante et contemporaine.



MOJAVE

'Avec des émaux réactifs, cette collection vous transporte sur une plage de sable fin.



| Dimension | ☛ | P.U. |
|--------------------|---|---------------------|
| Ø 27 cm - Plate | 6 | 114410 4,76€ |
| Ø 22 cm - Creuse | 6 | 114411 4,76€ |
| Ø 21 cm - Dessert | 6 | 114412 4,68€ |
| Ø 24 cm - Saladier | 4 | 114413 7,40€ |
| Ø 17 cm - Coupelle | 6 | 114414 4,76€ |

| Dimension | ☛ | P.U. |
|------------------------|---|---------------------|
| Ø 27 cm - Plate | 6 | 277324 4,06€ |
| Ø 23 cm - Creuse | 6 | 115279 4,06€ |
| Ø 21 cm - Dessert | 6 | 115280 3,92€ |
| Ø 15 cm - Bol | 4 | 115281 4,71€ |
| Ø 30 cl - Mug | 4 | 115282 4,13€ |
| Ø 22 cl - Tasse à thé | 6 | 115283 5,95€ |
| Ø 12 cl - Tasse à café | 6 | 115284 4,71€ |

LA VAISSELLE

Tendance & Décor

STONECAST

Collection emblématique de Churchill. Peintes à la main en 3 étapes puis protégées par une couche d'émail brillant ; chaque assiette est unique et ultra résistante. Combinez les coloris pour créer des ambiances propres à chaque établissement. En porcelaine, garantie 5 ans contre les ébréchures.

Autres coloris et autres formes **NOUS CONSULTER**



| Dimension | | Moutarde | Bleu | Gris | Blanc | P.U. |
|-------------------------|----|---------------|---------------|---------------|---------------|---------------|
| Ø 28,8 cm - Coupe Plate | 12 | 101902 | 101912 | 115149 | 115159 | 16,99€ |
| Ø 26 cm - Coupe Plate | 12 | 101901 | 101911 | 115148 | 115158 | 13,07€ |
| Ø 21,7 cm - Coupe Plate | 12 | 101905 | 101915 | 115152 | 115162 | 9,86€ |
| Ø 16,5 cm - Coupe Plate | 12 | 101904 | 101914 | 115151 | 115161 | 7,51€ |



| Dimension | | Moutarde | Bleu | Gris | Blanc | P.U. |
|--|----|---------------|---------------|---------------|---------------|---------------|
| Ø 24,8 cm - 113,6 cl - Creuse | 12 | 101903 | 101913 | 115150 | 115160 | 16,99€ |
| 22,9 cm - Plate Triangulaire | 12 | 101908 | 101918 | 115153 | 115163 | 13,23€ |
| 34,5 x 18,5 cm - Rectangulaire Oblong | 6 | 101907 | 101917 | - | - | 37,02€ |
| 35,5 x 18,9 cm - Chefs' Oblong n°4 | 6 | - | - | 115157 | 115167 | 32,69€ |
| 29,5 x 14 cm - Rectangulaire Oblong | 12 | 101906 | 101916 | - | - | 24,99€ |
| 29,8 x 15,3 cm - Rectangulaire Chefs' Oblong n°3 | 12 | - | - | 115156 | 115166 | 22,08€ |



| Dimension | | Moutarde | Bleu | Gris | Blanc | P.U. |
|------------------------------------|----|---------------|---------------|---------------|---------------|---------------|
| 60 cl - 23,5 cm - Bol Triangulaire | 12 | 101910 | 101920 | 115155 | 115165 | 20,26€ |
| 26 cl - 15,3 cm - Bol Triangulaire | 12 | 101909 | 101919 | 115154 | 115164 | 14,92€ |

LA VAISSELLE

Tendance & Décor

TERRE D'AZUR

'Collection avec un émail réactif où le décor peut varier d'un produit à l'autre.



| Dimension | ☛ | | P.U. |
|------------------|---|---------------|---------------|
| Ø 27 cm - Plate | 4 | 114593 | 11,05€ |
| Ø 25 cm - Creuse | 2 | 114594 | 15,61€ |
| 45 cl - Bol | 4 | 114595 | 9,72€ |

SAVEURS

Possède un émail réactif. Les teintes peut varier d'un produit à l'autre.



| Dimension | ☛ | ● Océan | ● Olive | P.U. |
|---------------------------------|---|---------------|---------------|---------------|
| Ø 23,5 cm - H 2,8 cm - Assiette | 2 | 115710 | 115711 | 9,42€ |
| Ø 19 cm - H 2,5 cm - Assiette | 3 | 115708 | 115709 | 5,10€ |
| Ø 19,5 cm - H 5,5 cm - Bol | 2 | 115707 | - | 11,80€ |
| Ø 16,5 cm - H 5 cm - Bol | 2 | - | 115706 | 8,43€ |
| Ø 14,5 cm - H 4,5 cm - Bol | 4 | 115704 | 115705 | 5,47€ |
| Ø 11,5 cm - H 4,5 cm - Bol | 6 | 115702 | 115703 | 4,79€ |

MATTIS CHARCOAL

'Collection avec un émail réactif où le décor peut varier d'un produit à l'autre. Bords droits facilitant la prise en main.



| Dimension | ☛ | ● Noir | ● Beige | ● Vert | P.U. |
|------------------------------|---|---------------|---------------|---------------|--------------|
| Ø 26,5 cm - Plate | 4 | 115718 | 115715 | 115712 | 9,32€ |
| Ø 17,5 cm - Bol | 4 | 115719 | 115716 | 115713 | 7,10€ |
| 120 cl - Ø 21 cm - Poke bowl | 4 | - | 115717 | 115714 | 8,19€ |

LA VAISSELLE

Tendance & Décor

DOTS

Teinte blanc



| Dimension | | Blanc | Jaune | Menthe | P.U. |
|-------------------------------|----|--------|--------|--------|--------|
| Ø 31 cm - Plate | 6 | 124267 | 100422 | 100455 | 15,21€ |
| Ø 26 cm - Plate | 24 | 124268 | 100423 | 100456 | 11,64€ |
| Ø 20 cm - Creuse | 24 | 124270 | 100430 | 100459 | 9,31€ |
| Ø 21 cm - Dessert | 24 | 124269 | 100428 | 100457 | 8,94€ |
| Ø 17 cm - Dessert | 24 | 100417 | 100429 | 100458 | 6,43€ |
| Ø 31 cm - Plat ovale | 10 | 124274 | 100446 | 124528 | 17,00€ |
| 18 x 18 cm - Plat | 12 | 124275 | 100447 | 124529 | 13,75€ |
| 18 x 12 cm - Plat | 12 | 124276 | 100448 | 124530 | 8,94€ |
| Ø 19 cm - Saladier | 18 | 124273 | 100445 | 124527 | 14,22€ |
| Ø 14 cm x 60 cl - Bol | 12 | 124271 | 100443 | 100460 | 9,67€ |
| Ø 17 cm x 60 cl - Bol | 18 | 124272 | 100444 | 100461 | 8,43€ |
| Ø 29 cl - Tasse déjeuner | 12 | 124281 | 100453 | 100502 | 9,82€ |
| Ø 16 cm - Sous-tasse déjeuner | 12 | 124282 | 100454 | 100503 | 5,55€ |
| Ø 21 cl - Tasse capucino | 12 | 124279 | 100451 | 124533 | 7,73€ |
| Ø 14 cm - Sous-tasse capucino | 12 | 124280 | 100452 | 100501 | 4,99€ |
| Ø 8 cl - Tasse moka | 12 | 124277 | 100449 | 124531 | 5,55€ |
| Ø 12 cm - Sous-tasse moka | 12 | 124278 | 100450 | 124532 | 4,39€ |

Teinte Jaune



Teinte Menthe

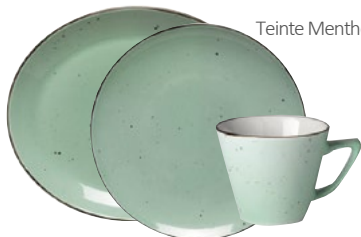

Teinte Mer



Teinte Terre



Teinte Ambre



| Dimension | | Mer | Terre | Ambre | Nuage | P.U. |
|-------------------------------|----|--------|--------|--------|--------|--------|
| Ø 31 cm - Plate | 6 | 100504 | 100738 | 100755 | 100574 | 15,21€ |
| Ø 26 cm - Plate | 24 | 100505 | 100739 | 100756 | 100575 | 11,64€ |
| Ø 20 cm - Creuse | 24 | 124534 | 100742 | 100789 | 100725 | 9,31€ |
| Ø 21 cm - Dessert | 24 | 100506 | 100740 | 100787 | 100576 | 8,94€ |
| Ø 17 cm - Dessert | 24 | 100507 | 100741 | 100788 | 100724 | 6,43€ |
| Ø 31 cm - Plat ovale | 10 | 100565 | 100746 | 100793 | 100729 | 17,00€ |
| 18 x 18 cm - Plat | 12 | 100566 | 100747 | 100794 | 100730 | 13,75€ |
| 18 x 12 cm - Plat | 12 | 100567 | 100748 | 100795 | 100731 | 8,94€ |
| Ø 19 cm - Saladier | 18 | 100564 | 100745 | 100792 | 100728 | 14,22€ |
| Ø 14 cm x 60 cl - Bol | 12 | 100562 | 100743 | 100790 | 100726 | 9,67€ |
| Ø 17 cm x 60 cl - Bol | 18 | 100563 | 100744 | 100791 | 124537 | 8,43€ |
| Ø 29 cl - Tasse déjeuner | 12 | 100572 | 100753 | 100826 | 100736 | 9,82€ |
| Ø 16 cm - Sous-tasse déjeuner | 12 | 100573 | 100754 | 124539 | 124538 | 5,55€ |
| Ø 21 cl - Tasse capucino | 12 | 124535 | 100751 | 100798 | 100734 | 7,73€ |
| Ø 14 cm - Sous-tasse capucino | 12 | 124536 | 100752 | 100799 | 100735 | 4,99€ |
| Ø 8 cl - Tasse moka | 12 | 100568 | 100749 | 100796 | 100732 | 5,55€ |
| Ø 12 cm - Sous-tasse moka | 12 | 100569 | 100750 | 100797 | 100733 | 4,39€ |

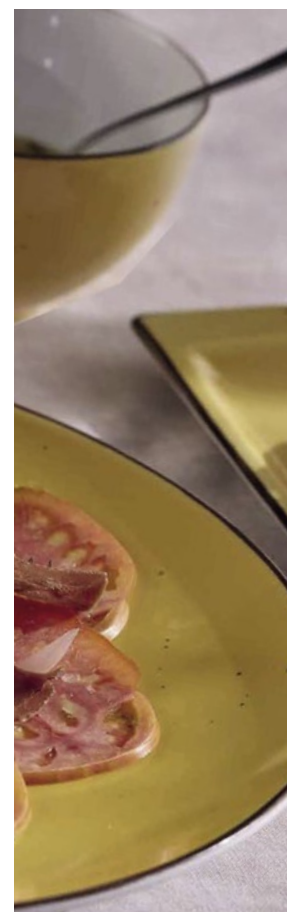

LA VAISSELLE

Tendance & Décor

ANDALUSI



| Dimension | Q | P.U. | Dimension | Q | P.U. |
|-------------------------|----|----------------------|---------------------------------|----|----------------------|
| Ø 31 cm - Plate Yís | 6 | 115289 17,65€ | 19 x 19 cm - Carrée | 24 | 115294 14,13€ |
| Ø 26,6 cm - Plate Aro | 6 | 115290 14,13€ | 31 x 25,5 x 3 cm - Plat ovale | 10 | 115296 14,83€ |
| Ø 26 cm - Plate | 24 | 115291 10,55€ | 31 x 12 cm - Plat rectangulaire | 10 | 115297 5,92€ |
| Ø 21 cm - Plate | 24 | 115292 7,84€ | 32 cl - Bol | 24 | 115298 8,72€ |
| Ø 9 cm - Plate | 12 | 115293 14,83€ | 21 cl - Tasse déjeuner | 12 | 115299 5,03€ |
| Ø 28 cm - Creuse à pâte | 12 | 115295 8,29€ | 10 cl - Tasse à café | 12 | 115300 7,64€ |

LUNAR



| Dimension | Q | P.U. | Dimension | Q | P.U. |
|------------------------|----|----------------------|-------------------------------|----|----------------------|
| Ø 31 cm - Plate | 6 | 100804 16,86€ | Ø 21 cm - Dessert | 24 | 100807 9,68€ |
| Ø 26 cm - Plate | 24 | 100805 12,88€ | Ø 17 cm - Dessert | 24 | 100808 7,45€ |
| Ø 25,8 cm - Plate Soia | 6 | 100813 16,53€ | 31 x 25,5 x 3 cm - Plat ovale | 10 | 100809 18,15€ |
| Ø 31 cm - Creuse Yís | 6 | 100810 24,35€ | Ø 28 x 15 cm - Plat | 6 | 100815 17,95€ |
| Ø 27 cm - Creuse Riso | 6 | 100806 21,00€ | Ø 18 x 18 cm - Plat | 12 | 100816 10,26€ |
| Ø 26,6 cm - Creuse Aro | 6 | 100812 17,19€ | Ø 17 x 6,5 cm - Bol | 18 | 100814 10,29€ |

LA VAISSELLE

Tendance & Décor

GONDOLA



| Dimension | Q | P.U. |
|-----------------------|----|----------------------|
| 28 x 24 cm - Plate | 6 | 101158 10,63€ |
| 28 x 15 cm - Plate | 6 | 124348 9,51€ |
| 21 x 21 cm - Creuse | 6 | 124347 8,14€ |
| 18 x 18 cm - Dessert | 12 | 100035 5,31€ |
| 18 x 12 cm - Dessert | 12 | 100036 4,51€ |
| 18 x 9 cm - Dessert | 24 | 101144 3,87€ |
| 13 x 6,5 cm - Dessert | 24 | 101145 2,88€ |

| Dimension | Q | P.U. |
|---------------------|---|----------------------|
| 60 x 18 cm - Plat | 2 | 124508 37,99€ |
| 45 x 10,5 cm - Plat | 4 | 124507 19,34€ |
| 38 x 21 cm - Plat | 6 | 124506 16,29€ |
| 36 x 18 cm - Plat | 6 | 124349 12,71€ |



| Dimension | Q | P.U. |
|-------------------------------|----|---------------------|
| 28 x 15 cm - Plateau déjeuner | 6 | 103605 9,05€ |
| 18 x 9 cm - Plateau café | 24 | 103606 3,71€ |
| 32 cl - Bol | 6 | 103604 6,03€ |

BAHIA



| Dimension | Q | P.U. |
|----------------------|----|----------------------|
| Ø 35 cm - Plate | 6 | 124519 18,13€ |
| Ø 31 cm - Plate | 6 | 124520 8,04€ |
| Ø 28 cm - Creuse | 6 | 124524 18,46€ |
| Ø 26 cm - Dessert | 24 | 124521 4,99€ |
| Ø 21 cm - Dessert | 24 | 124522 4,29€ |
| Ø 17 cm - Dessert | 24 | 124523 3,84€ |
| Ø 31 cm - Plat ovale | 10 | 124228 11,57€ |
| Ø 23 cm - Saladier | 10 | 124229 11,81€ |
| Ø 19 cm - Saladier | 18 | 124230 9,42€ |
| Ø 17 x 6,5 cm - Bol | 18 | 124525 4,75€ |
| Ø 14 x 7,5 cm - Bol | 12 | 124526 5,30€ |

LA VAISSELLE

Tendance & Décor

LINNEO AMMONITES



| Dimension | Q | | P.U. |
|------------------|---|---------------|---------------|
| Ø 30 cm - Plate | 6 | 124292 | 14,41€ |
| Ø 27 cm - Plate | 6 | 124293 | 11,88€ |
| Ø 27 cm - Creuse | 6 | 124294 | 10,89€ |
| 42 cl - Bol | 6 | 124295 | 7,11€ |

MALVA ROSSA

Ligne pure et intemporelle. Vaisselle robuste et élégante. Empilable et facile à transporter. Assiette facile à assortir à vos assiettes plates blanches ou fantaisie.



| Dimension | Q | | P.U. |
|---------------------|----|---------------|---------------|
| Ø 32 cm - Plate | 6 | 103607 | 9,84€ |
| Ø 28 cm - Plate | 12 | 101287 | 7,76€ |
| Ø 26 cm - Plate | 12 | 124511 | 5,62€ |
| Ø 31 cm - Creuse | 6 | 101293 | 14,31€ |
| Ø 22 cm - Creuse | 12 | 124514 | 5,96€ |
| Ø 20 cm - Dessert | 24 | 124512 | 4,17€ |
| Ø 16 cm - Dessert | 24 | 124513 | 3,45€ |
| 38 x 27 cm - Plat | 6 | 124515 | 14,27€ |
| 33 x 22,5 cm - Plat | 6 | 124516 | 11,18€ |
| 28 x 17,5 cm - Plat | 6 | 124517 | 9,66€ |
| 23 x 12 cm - Plat | 12 | 124518 | 7,82€ |

LA VAISSELLE

Les Inox

SELENA



| Dimension | Q | P.U. |
|---------------------------|----|---------------------|
| Ø 31 cm - Présentation | 6 | 124350 5,62€ |
| Ø 28 cm - Plate | 12 | 124351 4,19€ |
| Ø 25 cm - Plate | 24 | 124352 3,03€ |
| Ø 29,5 cm - Creuse | 6 | 124353 9,99€ |
| Ø 22 cm - Creuse | 24 | 124354 2,97€ |
| Ø 21 cm - Dessert | 24 | 124355 2,56€ |
| Ø 19 cm - Dessert | 24 | 124356 2,36€ |
| Ø 17 cm - Dessert | 24 | 124357 2,00€ |
| 30 cl - Bol à consommé | 24 | 124360 3,34€ |
| 25 cl - Tasse déjeuner | 24 | 124359 2,62€ |
| 18 cl - Tasse thé | 24 | 124358 2,17€ |
| Ø 15 cm - Sous-tasse thé | 24 | 124510 1,92€ |
| 9 cl - Tasse moka | 24 | 124361 1,64€ |
| Ø 12 cm - Sous-tasse moka | 24 | 124509 1,41€ |

AITANA

| Dimension | Q | P.U. |
|-----------------------------------|----|----------------------|
| Ø 26 cm - Plate | 24 | 124363 5,84€ |
| Ø 24 cm - Plate | 24 | 124364 5,69€ |
| Ø 23 cm - Creuse | 24 | 124365 5,00€ |
| Ø 20 cm - Dessert | 24 | 124366 3,97€ |
| Ø 16 cm - Dessert | 24 | 124367 3,48€ |
| 28 x 19 cm - Plate rectangulaire | 6 | 124369 9,55€ |
| 16 x 8,5 cm - Plate rectangulaire | 20 | 124368 3,04€ |
| 32 cl - Bol | 24 | 103608 4,39€ |
| Ø 7,8 cm - Théière | 12 | 103420 11,39€ |
| 100 gr - Couvercle théière | 1 | 103421 3,05€ |
| 23 cl - Tasse déjeuner | 24 | 124372 3,71€ |
| Ø 16 cm - Sous-tasse déjeuner | 24 | 124371 2,73€ |
| 19 cl - Tasse thé | 24 | 124373 3,38€ |
| 13 cl - Tasse café | 24 | 124374 2,72€ |



LA VAISSELLE

Tendance & Décor

VESUVIUS

| Dimension | | Lapis-lazuli | Vert émeraude | Ambre | P.U. |
|-------------------------------|---|---------------|---------------|---------------|----------------|
| Ø 30 cm - Plate - par 12 | 1 | 115738 | - | - | 639,72€ |
| Ø 28 cm - Plate - par 12 | 1 | 115735 | 115721 | 115737 | 622,80€ |
| Ø 25,25 cm - Plate - par 12 | 1 | 115727 | 115722 | 115729 | 489,06€ |
| Ø 23 cm - Plate - par 12 | 1 | 115723 | - | 115724 | 430,20€ |
| Ø 29 cm - Creuse - par 6 | 1 | - | - | 115739 | 422,73€ |
| Ø 25,25 cm - Creuse - par 12 | 1 | 115726 | 115728 | 115733 | 649,26€ |
| Ø 21,6 cm - Creuse - par 12 | 1 | 115731 | 115725 | 115734 | 489,06€ |
| Ø 20,25 cm - Dessert - par 12 | 1 | 115736 | 115730 | 115732 | 327,24€ |
| 33 x 19 cm - Plat - par 6 | 1 | - | - | 115741 | 659,61€ |
| Ø 14 cm - Bol - par 12 | 1 | - | - | 115740 | 302,04€ |



BASALT



| Dimension | | Bleu-vert | Menthe | P.U. |
|----------------------|----|---------------|---------------|--------------|
| Ø 26 cm - Plate | 6 | 115749 | 115747 | 9,66€ |
| Ø 24 cm - Creuse | 6 | 115742 | 115745 | 9,42€ |
| Ø 21 cm - Dessert | 6 | 115746 | 115751 | 7,70€ |
| Ø 11,5 cm - Coupelle | 6 | 115752 | 115748 | 5,54€ |
| Ø 10 cm - Coupelle | 6 | 115744 | 115743 | 4,83€ |
| Ø 9 cm - Sous-tasse | 12 | - | 115750 | 4,65€ |

LEGACY



| Dimension | | Vert | Bleu | Orange | P.U. |
|----------------------|---|---------------|---------------|---------------|----------------|
| Ø 25,25 cm - Plate | 1 | 115753 | 115756 | 115757 | 419,40€ |
| Ø 20,25 cm - Dessert | 1 | 115754 | 115755 | 115758 | 310,50€ |

OSLO

"Une série de service qui combine les atouts du design scandinave : simplicité, fonctionnalité, tranquillité et style. En porcelaine, donc résistant et simple à entretenir.

| Dimension | | P.U. |
|-----------------------------|----|----------------------------|
| Ø 26,5 cm - Plate | 18 | 115762 7,47€ |
| Ø 21 cm - Creuse | 24 | 115763 5,81€ |
| Ø 22 cm - Dessert | 36 | 115764 5,64€ |
| 30 cl - Gobelet | 48 | 115759 2,75€ |
| Ø 12,5 cm - H 6,3 cm - Bol | 48 | 115766 2,90€ |
| Ø 10,5 cm - H 5,4 cm - Bol | 48 | 115765 2,06€ |
| 10 cl - Tasse à café | 12 | 115760 1,88€ |
| Ø 12 cm - Sous-tasse à café | 12 | 115761 1,65€ |



LA VAISSELLE

Tendance & Décor

QUINTANA

'Quintana est un service avec une forme très simple aux bords verticaux et avec une profusion de couleurs. Existe en 3 coloris : ambre, vert, bleu. La série est faite en porcelaine et est très solide.



| Dimension | 📦 | ● Vert | ● Ambre | ● Bleu | P.U |
|-------------------------------|----|---------------|---------------|---------------|---------------|
| Ø 27,5 cm - Plate | 12 | 115784 | 115776 | 115774 | 12,38€ |
| Ø 23 cm - Creuse | 12 | 115783 | 115771 | 115768 | 9,30€ |
| Ø 19,5 cm - Creuse | 12 | 115787 | 115781 | - | 9,86€ |
| Ø 22 cm - Dessert | 24 | 115788 | 115772 | - | 9,23€ |
| Ø 19,5 cm - Bol | 6 | 115782 | - | 115767 | 21,29€ |
| 15 cl - Bol | 12 | - | 115779 | - | 2,36€ |
| 14 cl - H 8 cm - Bol | 12 | 115785 | 115789 | 115786 | 7,86€ |
| Ø 15 cm - H 4 cm - Coupelle | 6 | 115777 | 115775 | 115780 | 7,80€ |
| 22 cl - Tasse à café | 6 | - | 115769 | - | 5,60€ |
| 10 cl - Tasse à espresso | 6 | 115778 | 115773 | - | 3,42€ |
| 12 cl - Sous-tasse à espresso | 6 | - | - | 115770 | 3,11€ |

PLATO

'Un contraste clair et foncé ainsi qu'un style organique sont les mots clés de cette collection en porcelaine.



| Dimension | 📦 | P.U |
|--------------------------------|----|-----------------------------|
| Ø 27,5 cm - Plate | 12 | 115802 10,43€ |
| Ø 21,5 cm - Dessert | 6 | 115799 7,44€ |
| 32,5 x 28,5 cm - Ovale | 8 | 115798 23,64€ |
| 27 x 23 cm - Ovale | 12 | 115797 9,02€ |
| 19,5 x 16 cm - Ovale | 6 | 115796 6,90€ |
| Ø 20,5 cm - H 6,5cm - Coupelle | 4 | 115803 8,03€ |
| Ø 14 cm - H 8cm - Coupelle | 6 | 115800 5,15€ |
| 19 cl - Tasse à café | 6 | 115804 4,22€ |
| Ø 15 cm - Sous-tasse | 6 | 115801 3,02€ |

MAUNA

'La gamme de services Mauna offre une présentation attrayante sur n'importe quelle table. Les hauts bords en relief d'un blanc doux conduisent l'œil vers l'intérieur flamboyant où le vitrage réactif apporte une explosion de couleurs vibrantes. Les formes organiques uniques et apaisantes et l'extérieur lisse font passer chaque plat au niveau supérieur. Vaste gamme d'assiettes, de bols et d'une remarquable tasse.



| Dimension | 📦 | P.U |
|--------------------------------|----|-----------------------------|
| Ø 30 cm - Plate | 3 | 115808 14,88€ |
| 27 x 26,5 x H 2,5 cm - Plate | 18 | 115812 14,43€ |
| Ø 27 cm - Assiette spéciale | 8 | 115813 16,62€ |
| Ø 23,3 cm - Assiette spéciale | 12 | 115815 17,51€ |
| Ø 22,5 cm - Dessert | 4 | 115806 8,66€ |
| 21,5 x 21 x H 2,5 cm - Dessert | 24 | 115810 11,94€ |
| 27 x 26,5 x H 9,75 cm - Bol | 4 | 115811 29,12€ |
| 21 x 20 x H 5,5 cm - Bol | 1 | 115814 14,43€ |
| 20 x 19,5 x H 9,5 cm - Bol | 1 | 115807 21,51€ |
| 14,5 x 13,5 x H 7 cm - Bol | 1 | 115816 6,60€ |
| 38 cl - Tasse à café | 4 | 115805 6,44€ |
| Ø 16 cm - Sous-tasse | 6 | 115809 6,66€ |

COPENHAGUE

'Finition simple avec une ligne grise subtile, la porcelaine solide et la forme sobre avec un bord élevé vont parfaitement avec la philosophie scandinave.



| Dimension | 📦 | ○ Blanc | ● Vert | ● Rouge | P.U. |
|-------------------|---|---------------|---------------|---------------|---------------|
| Ø 30 cm - Plate | 1 | 114597 | - | - | 15,78€ |
| Ø 25 cm - Plate | 1 | - | 115795 | 115792 | 14,69€ |
| Ø 21 cm - Creuse | 1 | - | 115791 | 115790 | 17,40€ |
| Ø 21 cm - Dessert | 1 | - | 115794 | 115793 | 10,77€ |

LA VAISSELLE

Tendance & Décor

SEA PEARL

Sea Pearl se compose de 4 formes: rond, ovale, rectangulaire et triangulaire. Dans chaque forme, il y a une claire différence esthétique entre le côté intérieur et le côté extérieur. Le côté extérieur a une texture pierreuse, le côté intérieur est plus clair et a un bord accentué. L'ensemble est fait en grès et glacé, donc plus résistant à l'usure et plus beau.



SAPPHIRE

Une collection étendue à la couleur de la pierre précieuse de même nom. La teinte profonde au bord éclaircit vers le milieu et apporte une touche de mystère. La structure irrégulière de la pierre brute est devenue un élément du service.



| Dimension | Quantité | P.U |
|---------------------------------------|----------|----------------------|
| 40 x 23 x H 3 cm - Assiette triangle | 6 | 115822 21,74€ |
| Ø 26,5 x H 3,5 cm - Plate | 2 | 115825 13,26€ |
| 26,7 x 18,5 x H 3 cm - Plate ovale | 3 | 115821 13,13€ |
| Ø 22 x H 3 cm - Plate | 3 | 115826 8,72€ |
| Ø 18,5 x H 5-6,5 cm - Creuse coquille | 3 | 115819 10,74€ |
| Ø 14 cm - Dessert | 5 | 115827 5,72€ |
| Ø 22 x H 7 cm - Bol rond | 3 | 115820 10,07€ |
| 16 x H 4,5 cm - Coupelle | 3 | 115818 6,15€ |
| 9 x H 3 cm - Mini coupelle | 12 | 115817 2,66€ |
| 8,5 x H 8 cm - Tasse à café | 6 | 115824 4,23€ |
| 51 x 13 x H 3,5 cm - Plate rectangule | 16 | 115823 35,43€ |

| Dimension | Quantité | P.U |
|--------------------------|----------|----------------------|
| Ø 33 cm - Plate | 3 | 115830 21,68€ |
| Ø 27 cm - Plate | 12 | 115831 9,77€ |
| 19,5 x 16,5 cm - Creuse | 24 | 115832 7,89€ |
| 20,5 x 17,5 cm - Dessert | 24 | 115834 6,87€ |
| Ø 20 cm - Dessert | 24 | 115840 7,77€ |
| Ø 15,5 cm - Bol | 24 | 115839 6,99€ |
| 15 x 12 x H 8,5 cm - Bol | 24 | 115835 7,49€ |
| 10 x 7,5 x H 6 cm - Bol | 6 | 115833 3,23€ |
| 25 cl - Tasse à thé | 6 | 115837 4,02€ |
| 24 cl - Tasse à café | 6 | 115838 4,25€ |
| Ø 15 cm - Sous-tasse | 6 | 115836 3,77€ |
| 27,5 x 23 cm - Ovale | 4 | 115828 9,77€ |
| 36,5 x 15 cm - Ovale | 4 | 115829 10,28€ |

BALTIC

Baltic est un service de table en faïence polyvalent qui, grâce à ses différentes finitions et couleurs, est parfait aussi bien pour un usage quotidien que pour dresser une table de fête.



| Dimension | Quantité | Gris | Pêche | P.U | Magara | Vanille | P.U | Noir | Blanc | P.U |
|------------------------------|----------|---------------|---------------|--------------|---------------|---------------|--------------|---------------|---------------|--------------|
| Ø 27 cm - H 2,7 cm - Plate | 6 | 115848 | 115856 | 5,61€ | 115852 | 115864 | 6,32€ | 115844 | 115860 | 4,86€ |
| Ø 18,5 cm - H 5 cm - Creuse | 6 | 115846 | 115854 | 4,52€ | 115850 | 115862 | 5,07€ | 115842 | 115858 | 3,87€ |
| Ø 20 cm - H 2,2 cm - Dessert | 6 | 115847 | 115855 | 3,96€ | 115851 | 115863 | 4,46€ | 115843 | 115859 | 3,36€ |
| Ø 14,5 cm - H 6,7 cm - Bol | 6 | 115845 | 115853 | 3,71€ | 115849 | 115861 | 4,17€ | 115841 | 115857 | 3,18€ |

TORUS

Torus attirent les regards curieux avec une forme inclinée et des couleurs douces. Les bords larges et entièrement renforcés sont remarquables. Disponible en deux couleurs.



| Dimension | Quantité | Blanc bleu | Vert blanc | P.U |
|-----------------|----------|---------------|---------------|---------------|
| Ø 28 x H 6 cm | 10 | 114916 | 114919 | 34,41€ |
| Ø 24 x H 5,5 cm | 12 | 114917 | 114920 | 27,03€ |
| Ø 20,3 x H 5 cm | 16 | 114918 | 114922 | 16,38€ |
| Ø 16 x H 4,5 cm | 3 | 114915 | 114921 | 9,92€ |

LA VAISSELLE

Tendance & Décor

MIKURA

La surface matte et inégale, la couleur grise et la forme simple et traditionnelle donnent au service un aspect artisanal, rustique et industriel.



| Dimension | 📦 | | P.U. |
|---------------------------|----|---------------|--------------|
| 20 x 20 cm - Dessert | 6 | 114605 | 7,80€ |
| Ø 7 x H 2,7 cm - Coupelle | 24 | 114607 | 2,19€ |
| Ø 5 x H 4 cm - Pot | 6 | 114606 | 1,58€ |
| 17 cl - Pichet | 6 | 114604 | 6,78€ |

PANAMA



| Dimension | 📦 | | P.U. |
|-----------------|---|---------------|--------------|
| Ø 27 cm - Plate | 6 | 115865 | 6,80€ |
| Ø 21 cm - Plate | 6 | 115867 | 5,92€ |
| Ø 19 cm - Plate | 6 | 115866 | 6,80€ |

POTT BOWL



| Dimension | 📦 | Beige | Rose | P.U. |
|--------------------------|----|---------------|---------------|---------------|
| Ø 25 x H 4,6 cm - Creuse | 6 | 115873 | 115876 | 15,18€ |
| Ø 22 x H 4,4 cm - Creuse | 6 | 115872 | 115875 | 10,18€ |
| Ø 18 x H 4,6 cm - Creuse | 12 | 115871 | 115874 | 8,25€ |

MATERIA



| Dimension | 📦 | | P.U. |
|-----------------|---|---------------|--------------|
| Ø 27 cm - Plate | 6 | 115868 | 6,57€ |
| Ø 23 cm - Plate | 6 | 115869 | 5,51€ |
| Ø 19 cm - Plate | 6 | 115870 | 6,57€ |

RAINBOW & BLACK MAT



| Dimension | 📦 | Noir | P.U. | Blanc | P.U. |
|--------------------------|----|---------------|--------------|---------------|---------------|
| 21 x H 8 cm - Coupelle | 1 | - | | 114748 | 12,82€ |
| 16 x H 6,5 cm - Coupelle | 12 | - | | 114747 | 3,67€ |
| 12 x H 5 cm - Coupelle | 12 | 114601 | 4,83€ | 114744 | 2,84€ |



LA VAISSELLE

Tendance & Décor

ORE MAR

Variations de couleurs des assiettes Ore Mar, pour une ambiance très détendue. Finition brillante.



| Dimension | Quantité | Code | P.U. |
|----------------------------------|----------|---------------|---------------|
| Ø 27 x 2 cm - Plate | 12 | 115310 | 10,48€ |
| Ø 21 x 2 cm - Plate | 12 | 115311 | 7,69€ |
| Ø 25 x 5 cm - Creuse | 6 | 115313 | 15,72€ |
| 25 x 19 cm - Ovale | 12 | 115312 | 14,29€ |
| Ø 27 x 5,7 cm - Assiette à pâtes | 6 | 115314 | 18,86€ |
| Ø 6 cl - Coupelle | 24 | 115315 | 5,17€ |

TIERRA

Porcelaine colorée finition brillante. Couleur terre pour donner une atmosphère détendue.



| Dimension | Quantité | Code | P.U. |
|--------------------------------|----------|---------------|---------------|
| Ø 27 x 2 cm - Plate | 12 | 115316 | 10,48€ |
| Ø 23 x 2 cm - Plate | 12 | 115317 | 8,82€ |
| Ø 21 x 2 cm - Plate | 12 | 115318 | 7,69€ |
| Ø 25 x 4,5 cm - Creuse | 6 | 115320 | 15,72€ |
| Ø 23 x 3,6 cm - Creuse | 6 | 115319 | 12,20€ |
| Ø 27 x 4,5 cm - Creuse gourmet | 6 | 115321 | 15,81€ |
| 6 cl - Coupelle | 24 | 115322 | 4,58€ |

COSMO

En Porcelaine



| Dimension | Quantité | Code | P.U. |
|----------------------------|----------|---------------|---------------|
| Ø 29 cm - Plate | 6 | 103640 | 11,48€ |
| Ø 27 cm - Plate | 12 | 103636 | 7,76€ |
| Ø 24 cm - Plate | 12 | 103639 | 8,71€ |
| Ø 21 cm - Plate | 12 | 103635 | 5,70€ |
| Ø 26 cm - Creuse | 6 | 103641 | 14,14€ |
| Ø 23 cm - Creuse | 6 | 103637 | 9,05€ |
| Ø 24 cm - Assiette à pâtes | 6 | 103638 | 9,60€ |



MADERA

En Porcelaine

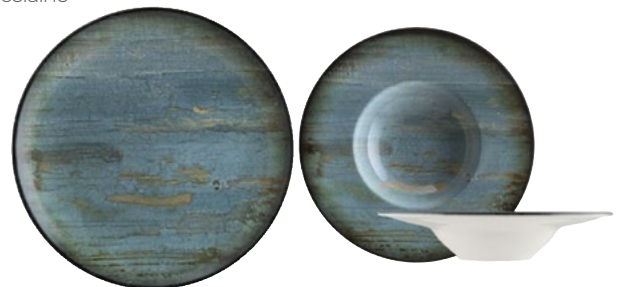

| Dimension | Quantité | Code | P.U. |
|----------------------------|----------|---------------|---------------|
| Ø 27 cm - Plate | 12 | 102088 | 8,02€ |
| Ø 21 cm - Plate | 12 | 102087 | 5,84€ |
| Ø 25 cm - Plate | 12 | 115877 | 7,48€ |
| Ø 28 cm - Assiette à pâtes | 6 | 102089 | 13,49€ |

LA VAISSELLE

Tendance & Décor

SWAY



| Dimension | ☛ | P.U. |
|------------------------|----|----------------------|
| Ø 32 x 2 cm - Plate | 6 | 115880 15,18€ |
| Ø 27 x 2 cm - Plate | 12 | 115879 9,54€ |
| Ø 21 x 2 cm - Plate | 12 | 115878 6,99€ |
| Ø 25 x 2 cm - Ovale | 12 | 115881 12,95€ |
| Ø 25 x 4,5 cm - Creuse | 6 | 115883 14,30€ |
| Ø 23 x 4,5 cm - Creuse | 6 | 115882 11,12€ |

BLOOM SEPIA



| Dimension | ☛ | P.U. |
|------------------------|----|----------------------|
| Ø 27 x 2 cm - Plate | 12 | 102085 8,67€ |
| Ø 21 x 2 cm - Plate | 12 | 115890 6,37€ |
| Ø 25 x 4,5 cm - Creuse | 6 | 102086 13,01€ |

LUNAR OCEAN



| Dimension | ☛ | P.U. |
|----------------------------------|----|----------------------|
| Ø 28 x 1,8 cm - Plate | 6 | 115892 14,66€ |
| Ø 22 x 1,7 cm - Plate | 6 | 115891 10,43€ |
| Ø 28 x 5,9 cm - Assiette à pâtes | 6 | 115893 20,49€ |
| Ø 14 x 5 cm - Coupelle | 12 | 115895 8,22€ |
| Ø 10 x 2,3 cm - Coupelle | 12 | 115894 4,60€ |

IRIS WITE



| Dimension | ☛ | P.U. |
|------------------------|----|----------------------|
| Ø 27 x 2 cm - Plate | 12 | 103633 7,38€ |
| Ø 21 x 2 cm - Plate | 12 | 103632 5,21€ |
| Ø 25 x 4,5 cm - Creuse | 6 | 103634 11,09€ |

IRIS GOURMET



| Dimension | ☛ | P.U. |
|------------------------|----|----------------------|
| Ø 27 x 2 cm - Plate | 12 | 115888 8,67€ |
| Ø 21 x 2 cm - Plate | 12 | 115887 6,34€ |
| Ø 23 x 4,5 cm - Creuse | 6 | 115889 10,11€ |

LA VAISSELLE

Tendance & Décor

ASSIETTE À PIZZA



| Dimension | Quantité | Code | P.U. |
|------------------------|----------|--------|--------|
| 32 x 2 - Patera | 6 | 115896 | 13,80€ |
| 32 x 2 - Madera | 6 | 115898 | 15,18€ |
| 32 x 2 - Gourmet blanc | 6 | 115899 | 10,66€ |
| 32,5 x 2 - Neat noir | 6 | 115900 | 15,98€ |
| 32 x 2 - Lotus | 6 | 115901 | 15,18€ |
| 32 x 2 - Luca Mozaic | 6 | 115902 | 15,18€ |
| 32 x 2,5 - Mesopotami | 6 | 115903 | 15,18€ |
| 27 x 2,5 - Mesopotami | 12 | 115905 | 9,54€ |
| 32 x 2 - Mesopotami | 6 | 115906 | 15,18€ |

FIUM



| Dimension | Quantité | Code | P.U. |
|----------------------|----------|--------|--------|
| 22 x 1,7 - Plate | 6 | 115914 | 9,48€ |
| 28 x 1,8 - Plate | 6 | 115915 | 13,35€ |
| 16 x 2 Dessert | 12 | 115916 | 6,64€ |
| 28 x 6 Creuse | 6 | 115917 | 18,65€ |
| 21 x 10 x 2 - Ovale | 12 | 115918 | 11,98€ |
| 10 x 6 x 2,4 - Ovale | 12 | 115919 | 4,60€ |
| 10 x 2,3 Coupelle | 12 | 115920 | 4,19€ |
| 10 x 2 Bol | 12 | 115921 | 4,19€ |
| 14 x 5 Bol | 12 | 115922 | 7,47€ |

VIENTO



| Dimension | Quantité | Code | P.U. |
|---------------------|----------|--------|--------|
| 27 x 2 - Plate | 12 | 115907 | 9,54€ |
| 22 x 2 - Plate | 6 | 115908 | 10,43€ |
| 32 x 1,1 - Pizza | 6 | 115904 | 16,70€ |
| 16 x 2 - Dessert | 12 | 115910 | 7,31€ |
| 25 x 4,5 - Creuse | 6 | 115911 | 15,72€ |
| 34 x 23 x 2 - Ovale | 6 | 115912 | 24,45€ |
| 36 x 17 x 1 - Vago | 12 | 115913 | 23,16€ |

BANQUET

Porcelaine



| Dimension | Quantité | Code | P.U. |
|------------------------|----------|--------|-------|
| 27 x 2 Plate | 12 | 115925 | 6,42€ |
| 25 x 2 Plate | 12 | 115924 | 5,77€ |
| Plate 21 x 2 | 12 | 115923 | 4,54€ |
| 28 x 4,5 Pasta | 6 | 115927 | 11,5€ |
| 15 x 2 Dessert | 12 | 115926 | 2,99€ |
| 12 x 4,5 Bol empilable | 12 | 115928 | 4,10€ |

LA VAISSELLE

Spécialité

EVOLUTIONS BLACK AND WHITE

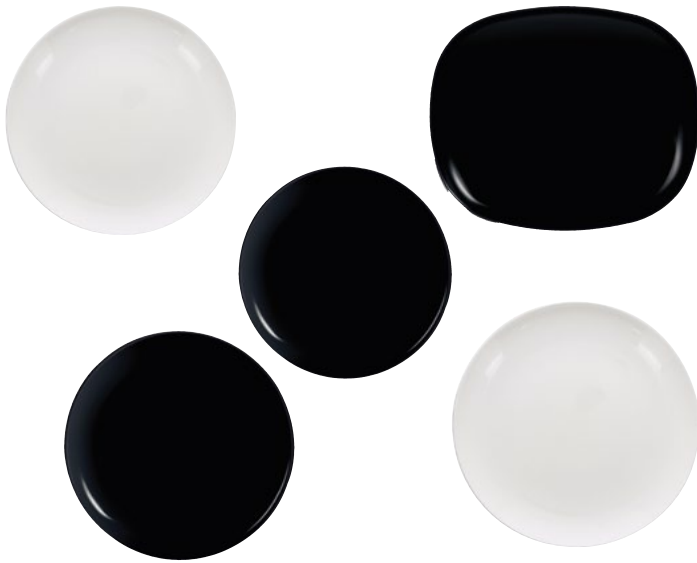

| Dimension | Blanc | P.U. | Noir | P.U. |
|----------------------------------|-------|---------------|---------------|----------------------------|
| Ø 27 cm - Plate | 24 | 101948 | 1,77€ | 101941 1,90€ |
| 28,5 x 4,5 cm - Assiette à pâtes | 12 | - | 3,97€ | 101410 3,97€ |
| Ø 25 cm - Plate | 24 | 101949 | 1,64€ | 101942 1,76€ |
| 32 x 2,4 cm - Pizza | 2 | 101411 | 22,3€ | 101408 3,97€ |
| Ø 19 cm - Plate | 24 | - | 101943 | 1,64€ |
| 30 x 3 cm - Steak | 12 | 101428 | 4,12€ | 101409 3,97€ |
| Ø 20 cm - Calotte | 24 | 101945 | 1,64€ | 101940 1,76€ |
| 28 x 23 cm - Rectangulaire | 12 | - | 101944 | 2,54€ |

'ASSIETTE SPÉCIALE



| Dimension | P.U. |
|----------------------|------------------------------|
| Ø 31 cm - Pizza | 6 100330 4,50€ |
| 33 x 25,5 cm - Steak | 6 100339 3,74€ |

CARPACCIO



| Dimension | P.U. |
|-------------------|------------------------------|
| 35 x 25 cm - Plat | 6 111875 6,43€ |
| 31 x 21 cm - Plat | 6 111876 4,50€ |
| 25 x 18 cm - Plat | 6 111877 3,66€ |

SEAU À FRITES



| Dimension | P.U. |
|-------------------------|------------------------------|
| Ø 10 x H 10 cm - Cuivre | 6 114751 8,54€ |
| Ø 10 x H 10 cm - Inox | 6 114752 6,23€ |

PASTA CREUSE



| Dimension | P.U. |
|------------------|-------------------------------|
| Ø 30 cm - Creuse | 6 100157 5,09€ |
| Ø 26 cm - Creuse | 6 100158 4,35€ |
| Ø 21 cm - Creuse | 24 100159 3,30€ |



| Dimension | P.U. |
|-----------|------------------------------|
| Inox | 1 102454 6,31€ |
| Bronze | 1 102456 6,31€ |



| Dimension | P.U. |
|--------------------|-------------------------------|
| 17 x 18 - par 1000 | 4 115064 19,17€ |
| 13 x 14 - par 1000 | 6 115063 12,77€ |

LA VAISSELLE

Collectivité

CARRÉ HOTEL

En Porcelaine



| Dimension | Quantité | Code | P.U. |
|--------------------------------------|----------|--------|-------|
| 30 x 30 cm - Plate | 4 | 109530 | 9,19€ |
| 27 x 27 cm - Plate | 24 | 100154 | 5,89€ |
| 25 x 25 cm - Plate | 24 | 109525 | 4,64€ |
| 28 x 15 cm - Plate | 6 | 109528 | 5,06€ |
| 23,5 x 11 cm - Plate | 6 | 109523 | 4,28€ |
| 15 x 13 cm - Plate | 48 | 109515 | 3,50€ |
| 20 x 20 cm - Creuse | 24 | 109520 | 4,21€ |
| 19 x 19 cm - Dessert | 24 | 109519 | 4,16€ |
| 22 x 22 x 8 cm - Saladier | 4 | 111871 | 7,85€ |
| 16 x 16 x 6,4 cm - Saladier | 6 | 111870 | 4,14€ |
| 20 cl - Tasse déjeuner | 6 | 124541 | 2,71€ |
| 15,1 x 15,1 cm - Sous-tasse déjeuner | 6 | 101336 | 2,36€ |
| 9 cl - Tasse café | 6 | 109509 | 2,52€ |
| 13,6 x 13,6 cm - Sous-tasse café | 6 | 109513 | 2,16€ |

OSLO

La véritable collection Oslo en Porcelaine Pyroblan! Cette ligne est à la hauteur de sa réputation (solidité & hygiène). Une parfaite compacité pour un gain de place, une fonctionnalité et une facilité de prise en main optimisée...



| Dimension | Quantité | Code | P.U. |
|---------------------------------------|----------|--------|-------|
| 24,5 x 23,8 - Plate | 24 | 100324 | 4,35€ |
| 22 x 21,2 - Plate | 24 | 100322 | 4,07€ |
| 18,8 x 18,2 - Plate | 48 | 100319 | 3,21€ |
| 22 x 21,2 - Creuse | 24 | 100323 | 4,07€ |
| 15 x 14,3 - Creuse | 72 | 100315 | 2,52€ |
| 13,3 x 12,7 - Creuse | 96 | 100313 | 2,52€ |
| 19 x 11 cm - Plat sabot empilable | 36 | 106107 | 4,00€ |
| 11 x 11 cm - Ravier empilable | 72 | 106109 | 2,24€ |
| 60cl - Bol | 36 | 106206 | 5,04€ |
| 40cl - Bol | 36 | 106205 | 4,24€ |
| 8 cl - Coupelle | 48 | 106120 | 1,61€ |
| 28cl - Tasse déjeuner | 36 | 114561 | 3,57€ |
| 15cl - Tasse à thé | 48 | 114565 | 2,95€ |
| 9cl - Tasse à café | 48 | 114567 | 2,55€ |
| Ø 15,5 x 4,4 cm - 37 cl - Comptier | 36 | 106112 | 2,98€ |
| Ø 13 x 4 cm - 22,5 cl - Comptier | 48 | 106106 | 2,46€ |
| Ø 12 x 3,5 cm - 15 cl - Comptier haut | 48 | 106105 | 2,13€ |

UNIVERSAL

En porcelaine.



Compatible avec la gamme Oslo

| Dimension | Quantité | Code | P.U. |
|--------------------------|----------|--------|-------|
| Ø 24,5 cm - Plate | 12 | 113763 | 3,41€ |
| Ø 22 cm - Plate | 12 | 113764 | 3,18€ |
| Ø 22 cm - Creuse | 12 | 113766 | 3,04€ |
| Ø 19 cm - Dessert | 12 | 113765 | 2,51€ |
| Ø 19 cm - Comptier bas | 12 | 113767 | 2,51€ |
| Ø 15 cm - Comptier bas | 12 | 113768 | 2,08€ |
| Ø 13,5 cm - Comptier bas | 12 | 113769 | 1,87€ |

BUFFET RD

En porcelaine



| Dimension | Quantité | Code | P.U. |
|------------------------------|----------|--------|--------|
| Ø 24 x H 2 cm - Plate | 1 | 115931 | 4,50€ |
| Ø 26 x H 4 cm - Creuse | 6 | 115932 | 6,36€ |
| Ø 23 x H 3,5 cm - Creuse | 1 | 115930 | 4,40€ |
| Ø 21 x H 1,5 cm - Dessert | 1 | 115929 | 4,17€ |
| Ø 23 x H 6 cm - Saladier | 1 | 115934 | 11,12€ |
| Ø 16 x H 4,5 cm - Saladier | 1 | 115933 | 5,58€ |
| 40 cl - Théière | 1 | 115935 | 12,57€ |
| 20 cl - Tasse à thé | 1 | 115938 | 4,31€ |
| Ø 15 x H 1,5 cm - Sous tasse | 12 | 115939 | 2,15€ |
| 9 cl - Tasse à café | 12 | 115936 | 2,78€ |
| Ø 13 x H 1,9 cm - Sous tasse | 12 | 115937 | 2,04€ |

LA VAISSELLE

Collectivité

HEAT SYSTEM

Les assiettes Heat System ont été étudiées spécifiquement pour fonctionner avec les matériaux utilisés dans les hôpitaux tels que les systèmes de chauffe par thermo-contact ou à air pulsé. Fabriquées en Opal, ces assiettes font bénéficier aux professionnels des atouts suivants : aucun risque bactériologique, montée et maintien en température identique à la porcelaine à épaisseur égale.



| Dimension | ● | P.U. |
|-------------------------------------|----|---------------------|
| Ø 22,8 cm - Plate - 2 compartiments | 24 | 123889 8,26€ |
| Ø 22,8 x 2,5 cm - Plate | 24 | 114280 7,65€ |
| Ø 23 cm - Ronde - compartimentée | 12 | 123886 9,21€ |
| Ø 12 cm - 40 cl - Bol | 24 | 123888 2,35€ |

RESTAURANT UNI



| Dimension | ● | P.U. |
|------------------------------------|----|---------------------|
| Ø 23,5 cm - Plate | 24 | 107823 3,75€ |
| Ø 19,5 cm - Plate | 24 | 107819 3,30€ |
| Ø 15,5 cm - Plate | 24 | 107815 2,58€ |
| Ø 22,5 cm - Creuse | 24 | 107822 3,75€ |
| Ø 7,8 cm - 22 cl - Tasse empilable | 48 | 103418 1,91€ |
| Ø 15,3 cm - Sous-tasse déjeuner | 36 | 103419 1,67€ |
| Ø 7,8 cm - 19 cl - Tasse thé | 48 | 103416 2,05€ |
| Ø 14 cm - Sous-tasse thé | 48 | 103417 1,49€ |
| Ø 6,9 cm - 13 cl - Tasse empilable | 48 | 103414 1,95€ |
| Ø 13 cm - Sous-tasse | 48 | 107813 1,34€ |
| Ø 6 cm - 8 cl - Tasse empilable | 48 | 124655 1,56€ |
| Ø 11,2 cm - Sous-tasse | 48 | 103413 1,22€ |

NOVA AQUITANIA

Gamme très légère 290 grammes.



| Dimension | ● | P.U. |
|--------------------|----|---------------------|
| Ø 22,5 cm - Plate | 24 | 103642 1,19€ |
| Ø 15,5 cm - Plate | 24 | 103644 1,05€ |
| Ø 22,5 cm - Creuse | 24 | 103643 1,18€ |
| Ø 13 cm - Coupelle | 36 | 103645 1,10€ |
| 50 cl - Bol | 12 | 103646 1,37€ |





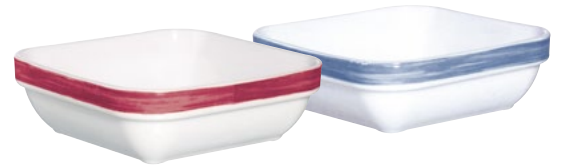

LA VAISSELLE

Collectivité

BRUSH

La collection Brush est entièrement empilable et très résistante. Elle est conçue pour optimiser l'espace sur les plateaux.



| Dimension | Quantité |  Aile Bleue |  Aile Bleue Foncée |  Aile Orange |  Aile Jaune |  Aile Rouge |  Aile Verte | P.U. |
|--------------------------------------|----------|--|---|---|--|--|--|--------------|
| Ø 25,4 cm - Plate | 24 | 111996 | 113743 | 111997 | 111995 | 113754 | 111994 | 5,85€ |
| Ø 23,5 cm - Plate | 24 | 110523 | 113742 | 110923 | 110823 | 113753 | 110623 | 5,46€ |
| Ø 22,5 cm - Creuse | 24 | 110522 | 113739 | 110922 | 110821 | 113750 | 110622 | 5,46€ |
| Ø 19,5 cm - Dessert | 24 | 110519 | 113740 | 110919 | 110820 | 113751 | 110619 | 4,71€ |
| Ø 15,5 cm - Dessert | 24 | 110515 | 113741 | 110915 | 110815 | 113752 | 110615 | 4,27€ |
| Ø 12 x H 4,7 cm - Saladier empilable | 36 | 110924 | 113733 | 110926 | 110927 | 113744 | 110925 | 3,45€ |
| Ø 12 x H 2,6 cm - Tl cl - Coupelle | 36 | 119512 | 113738 | - | - | 113749 | 110612 | 3,41€ |
| 11 x H 11 cm - Ravier | 24 | 110918 | 101348 | - | - | 101349 | - | 6,64€ |
| 51 cl - 13,2 cm - Bol déjeuner | 36 | 110917 | 113737 | 110913 | 110914 | 113748 | 110916 | 4,27€ |
| 25 cl - Mug | 36 | 110900 | 113736 | 110902 | 110903 | 113747 | 110901 | 3,92€ |
| 19 cl - Tasse thé empilable | 48 | 110904 | 113735 | 110905 | 110906 | 113746 | 110907 | 3,99€ |
| Ø 14 cm - Sous-tasse thé | 48 | 110908 | 113734 | 110910 | 110911 | 113745 | 110909 | 3,52€ |

LA VAISSELLE

Collectivité

FESTON CARACAS



| Dimension | | P.U. |
|-------------------------|------------------|-------|
| Ø 27,3 cm - Plate | 36 101346 | 1,49€ |
| Ø 25 cm - Plate | 24 101347 | 1,36€ |
| Ø 23 cm - Plate | 36 107923 | 1,29€ |
| Ø 21 cm - Creuse | 36 107921 | 1,29€ |
| Ø 19 cm - Dessert | 24 107919 | 1,23€ |
| Ø 30 cm - Plat | 6 102094 | 4,60€ |
| Ø 28 cm - Plat creux | 16 102095 | 4,86€ |
| 33 x 25 cm - Plat ovale | 6 102096 | 4,60€ |
| Ø 24 cm - Saladier | 6 102098 | 3,65€ |
| Ø 12 cm - Saladier | 24 102097 | 1,14€ |

STAIRO

Un design intemporelle une fois et demi plus légère que la porcelaine professionnelle et 3 fois plus résistante,



| Dimension | | P.U. |
|----------------------|------------------|-------|
| Ø 27 cm - Plate | 24 123890 | 1,59€ |
| Ø 25 cm - Plate | 24 123891 | 1,22€ |
| Ø 23,6 cm - Creuse | 24 123894 | 1,22€ |
| Ø 19 cm - Dessert | 24 123893 | 1,17€ |
| Ø 23,5 cm - Plate | 24 123892 | 1,21€ |
| Ø 27 cm - Saladier | 6 102091 | 3,75€ |
| 88 cl - Bol consommé | 24 102092 | 1,79€ |
| 50 cl - Bol | 36 102093 | 1,61€ |

EVERYDAYS



| Dimension | | P.U. |
|---------------------|------------------|-------|
| Ø 26,5 cm - Plate | 24 124151 | 1,62€ |
| Ø 24,5 cm - Plate | 24 124152 | 1,28€ |
| Ø 22,5 cm - Creuse | 24 124154 | 1,28€ |
| Ø 19,5 cm - Dessert | 24 124153 | 1,21€ |

LA VAISSELLE

Collectivité

SALSA - WINTER

'La collection Salsa est très résistantes aux chocs et aux écarts de températures. Fabriquées à 100% en mélamine de haute qualité.



| Dimension | Q | P.U. |
|-------------------|------------------|---------------|
| Ø 27,9 cm - Plate | 24 115944 | 10,21€ |
| Ø 22,9 cm - Plate | 24 115943 | 8,24€ |
| Ø 17,8 cm - Plate | 24 115942 | 5,10€ |
| Ø 24 cm - Bol | 24 115941 | 8,82€ |
| Ø 19,05 cm - Bol | 24 115940 | 7,42€ |

SALSA - SUMMER



| Dimension | Q | P.U. |
|-------------------|------------------|---------------|
| Ø 27,9 cm - Plate | 24 115949 | 10,21€ |
| Ø 22,9 cm - Plate | 24 115948 | 8,24€ |
| Ø 17,8 cm - Plate | 24 115947 | 5,10€ |
| Ø 24 cm - Bol | 24 115946 | 8,82€ |
| Ø 19,05 cm - Bol | 24 115945 | 7,42€ |



LA VAISSELLE

Bols et petits contenants

BOLS EMPILABLES



| Dimension | Quantité | P.U. |
|-------------|------------------|--------------|
| 52 cl - Bol | 36 106095 | 1,71€ |
| 48 cl - Bol | 36 123884 | 1,50€ |



| Dimension | Quantité | P.U. |
|-----------------------------------|------------------|---------------|
| 51 cl - Bol | 72 106091 | 1,55€ |
| 14 x 9 x 3,5 cm - Lot de 3 ravers | 8 106148 | 11,45€ |



| Dimension | Quantité | P.U. |
|---|------------------|--------------|
| Ø 16 x 3,6 cm - 27,5 cl - Comptier | 36 123879 | 2,71€ |
| Ø 12 x 2,6 cm - 11 cl - Comptier | 36 123878 | 2,13€ |
| 14 x 9 x 3,5 cm - Ravier empilable | 24 106092 | 3,76€ |
| 11 x 11 x 3,6 cm - Ravier empilable | 24 123882 | 3,68€ |
| Ø 14 x 14 x 5,2 cm - 48 cl - Saladier empilable | 36 123877 | 3,32€ |
| Ø 12,1 x 4,7 cm - 31,5 cl - Saladier empilable | 36 123876 | 2,13€ |

BRISBANE



| Dimension | Quantité | P.U. |
|---|-----------------|--------------|
| Ø 8,8 x H 4,4 cm - Ramequins (lot de 3) | 6 115956 | 2,06€ |

YARA BLACK



| Dimension | Quantité | P.U. |
|------------------------------|------------------|--------------|
| Ø 12,2 x H 5,2 cm - Ramequin | 6 115958 | 3,90€ |
| Ø 9 x H 4,5 cm - Ramequin | 12 115959 | 1,79€ |
| Ø 7 x H 3,5 cm - Ramequin | 12 115957 | 1,38€ |

BUFFET CR



| Dimension | Quantité | P.U. |
|-------------------------------------|-----------------|---------------|
| 20 cl - Ø 10 x H 5 cm - Ramequin | 2 115960 | 28,94€ |
| 12 cl - Ø 8,2 x H 4,5 cm - Ramequin | 2 115961 | 19,61€ |

ESSENTIALS



| Dimension | Quantité | P.U. |
|-------------------|------------------|--------------|
| Ø 9 cm - Ramequin | 64 115963 | 1,05€ |
| Ø 7 cm - Ramequin | 12 115962 | 0,68€ |

OSLO



| Dimension | Quantité | P.U. |
|----------------------------------|------------------|--------------|
| 25 cl - 15 x 9 x 3,5 cm - Ravier | 72 115965 | 2,44€ |

LA VAISSELLE

Saladiers et culinaires

Ô CUISINE

| Dimension | Quantité | Code | P.U. |
|----------------------------|----------|--------|-------|
| 39 x 27 cm - Oval | 4 | 101480 | 7,83€ |
| 35 x 24 cm - Oval | 6 | 101479 | 6,66€ |
| 30 x 21 cm - Oval | 4 | 101478 | 5,42€ |
| 25 x 22,5 cm - Carré | 6 | 101481 | 4,71€ |
| 39 x 23 cm - Rectangulaire | 6 | 101477 | 7,83€ |
| 35 x 23 cm - Rectangulaire | 6 | 101476 | 6,66€ |
| 32 x 20 cm - Rectangulaire | 7 | 101475 | 5,42€ |



MISTER CHEF



| Dimension | Quantité | Code | P.U. |
|--------------------|----------|--------|--------|
| Ø 30 cm - Saladier | 6 | 100781 | 12,10€ |
| Ø 26 cm - Saladier | 6 | 100780 | 8,52€ |
| Ø 22 cm - Saladier | 6 | 100779 | 6,82€ |
| Ø 17 cm - Saladier | 12 | 100778 | 4,52€ |
| Ø 14 cm - Coupelle | 24 | 100777 | 2,51€ |
| Ø 11 cm - Coupelle | 24 | 100823 | 1,96€ |
| Ø 9 cm - Coupelle | 36 | 100822 | 1,43€ |

EMPILABLE



| Dimension | Quantité | Code | P.U. |
|----------------------|----------|--------|-------|
| Ø 31 cm - Saladier | 6 | 109561 | 7,51€ |
| Ø 26 cm - Saladier | 12 | 106090 | 5,15€ |
| Ø 23 cm - Saladier | 12 | 106089 | 3,14€ |
| Ø 20 cm - Saladier | 24 | 106088 | 2,55€ |
| Ø 17 cm - Saladier | 24 | 106087 | 1,79€ |
| Ø 14 cm - Saladier | 48 | 106086 | 1,31€ |
| Ø 12 cm - Saladier | 72 | 106085 | 0,93€ |
| Ø 10,5 cm - Saladier | 72 | 106084 | 0,76€ |
| Ø 6 cm - Saladier | 36 | 106083 | 0,74€ |



LA VAISSELLE

Les fontes

Batería MINI FAITOUT





Dimension

Ø14 cm - H 7,5 cm - Rond

Ø10 cm - H 5 cm - Rond

12 x 8,5 cm - Ovale

| |  Rouge |  Noir | P.U. |
|---|---|--|---------------|
| 1 | 115951 | 123122 | 23,93€ |
| 1 | 115950 | 123121 | 16,31€ |
| 1 | 115954 | 123123 | 17,18€ |



LES ESSENCES



| Dimension | Argent | P.U. | Noir | Or | P.U. | |
|---|--------|---------------|--------------|---------------|---------------|--------------|
| 7,5 cm - Cuillères à dégustation pique | 1 | 115967 | 2,19€ | 115972 | 115973 | 4,64€ |
| 7,5 cm - Cuillères à dégustation pique (avec trous) | 1 | 115976 | 2,32€ | - | - | - |



| Dimension | Argent | P.U. | Noir | Or | P.U. | |
|--|--------|---------------|--------------|---------------|---------------|--------------|
| 8,5 cm - Cuillères à dégustation à manche | 1 | 115979 | 2,56€ | 115980 | 115970 | 4,99€ |
| 8,5 cm - Cuillères à dégustation à manche (avec trous) | 1 | 115981 | 2,69€ | - | - | - |



| Dimension | Argent | P.U. | Noir | Or | P.U. | |
|--|--------|---------------|--------------|---------------|---------------|--------------|
| 8,5 cm - Cuillères à dégustation plate | 1 | 115968 | 2,08€ | 115969 | 115975 | 4,51€ |



| Dimension | Argent | P.U. | Noir | Or | P.U. | |
|---|--------|---------------|--------------|---------------|---------------|--------------|
| 7,1 cm - Cuillères à dégustation spatule | 1 | 115971 | 2,32€ | 115974 | 115977 | 4,75€ |
| 7,1 cm - Cuillères à dégustation spatule (avec trous) | 1 | 115978 | 2,45€ | - | - | - |

SILEX



| Dimension | P.U. |
|------------------------------------|-------------------------------|
| Couteau | 1 124619 11,41€ |
| Couteau et fourchette avec planche | 1 114286 22,82€ |



LA VAISSELLE

Les Inox



| Dimension | | P.U. |
|---------------------------------|-----------------|---------------|
| Pelle de service - 38,5 x 16 cm | 1 115332 | 13,51€ |



| Dimension | | P.U. |
|--|-----------------|---------------|
| Plaque triangulaire - 29 x 29 x 1,5 cm | 1 115333 | 17,59€ |



| Dimension | | P.U. |
|--|-----------------|---------------|
| 32 x 24 x 3 cm - Plateau à poignée | 1 115339 | 16,44€ |
| 32 x 24 x 1,5 cm - Plateau à poignée | 1 115338 | 15,40€ |
| 32 x 18 x 3 cm - Plateau à poignée | 1 115341 | 15,01€ |
| 32 x 18 x 1,5 cm - Plateau à poignée | 1 115340 | 14,07€ |
| 26,5 x 23 x 3 cm - Plateau à poignée | 1 115337 | 15,34€ |
| 26,5 x 23 x 1,5 cm - Plateau à poignée | 1 115336 | 14,38€ |
| 22 x 14 x 3 cm - Plateau à poignée | 1 115335 | 13,25€ |
| 22 x 14 x 1,5 cm - Plateau à poignée | 1 115334 | 12,40€ |



| Dimension | | P.U. |
|-------------------------------------|-----------------|---------------|
| Plateau de présentation avec manche | 1 115346 | 25,68€ |
| Plateau de présentation sans manche | 1 115347 | 26,13€ |
| Plateau de présentation 1/1GN | 1 115348 | 30,54€ |
| Plateau de présentation rond | 1 115349 | 25,87€ |
| Plateau de présentation rond | 1 115350 | 31,68€ |

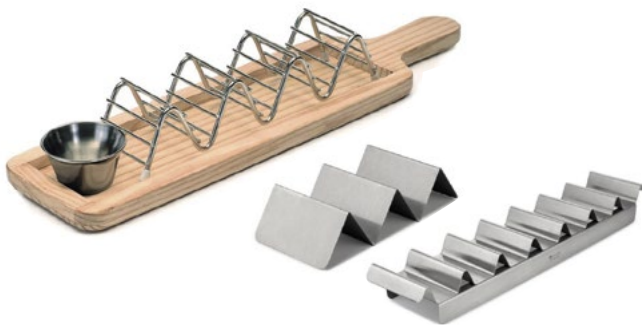

| Dimension | | P.U. |
|---------------------------------------|-----------------|---------------|
| Plateau à tacos avec base en bois | 1 115351 | 18,14€ |
| 7 compartiments - Plateau à sandwichs | 1 115354 | 14,04€ |
| 4-5 compartiments - Plateau à tacos | 1 115353 | 6,42€ |
| 2-3 compartiments - Plateau à tacos | 1 115352 | 4,38€ |



| Dimension | | P.U. |
|------------------------------|-----------------|---------------|
| 40 x 29 cm - Base en liège | 1 115344 | 22,68€ |
| 40 x 23 cm - Base en liège | 1 115345 | 19,58€ |
| 34,5 x 28 cm - Base en liège | 1 115343 | 20,00€ |
| 30 x 19 cm - Base en liège | 1 115342 | 13,38€ |

LA VAISSELLE

Collectivité

Gamme BARISTA



| Dimension | Quantité | Ivoire | P.U. | Rouge | P.U. | Orange | P.U. | Noir | P.U. |
|---|----------|---------------|--------------|---------------|--------------|---------------|--------------|---------------|--------------|
| 30 cl - Tasse | 6 | 114820 | 3,36€ | - | - | - | - | - | - |
| 20 cl - 8,7 x h 7 cm - Tasse | 12 | 114783 | 2,46€ | 114784 | 2,69€ | 114785 | 2,61€ | 114815 | 2,69€ |
| 15 cl - 8 x h 6,5 cm - Tasse | 12 | 114823 | 2,36€ | 114788 | 2,49€ | 114786 | 2,46€ | 114789 | 2,52€ |
| 7 cl - 6,3 x h 6,2 cm - Tasse | 12 | 114822 | 1,97€ | 114791 | 2,09€ | 114824 | 2,04€ | 114790 | 2,10€ |
| Ø 16 cm - Sous-tasse (pr tasse 20-30cl) | 12 | 114819 | 1,97€ | 114826 | 2,10€ | 114793 | 2,04€ | - | - |
| Ø 13 cm - Sous-tasse (pr tasse 7-15cl) | 12 | 114818 | 1,62€ | 114825 | 1,68€ | 114796 | 1,68€ | 114797 | 1,74€ |



| Dimension | Quantité | Noir | P.U. |
|-----------------------------|----------|---------------|---------------|
| 50 cl - Théière avec filtre | 1 | 115983 | 19,38€ |

| Dimension | Quantité | Amande | P.U. |
|-----------------------------|----------|---------------|---------------|
| 50 cl - Théière avec filtre | 1 | 115982 | 19,38€ |



| Dimension | Quantité | P.U. |
|---------------------------|----------|-----------------------------|
| 45 cl - Duo tasse théière | 1 | 115984 14,71€ |



| Dimension | Quantité | Blanc | Noir | P.U. |
|-----------------------------|----------|---------------|---------------|---------------|
| 50 cl - Théière avec filtre | 1 | 115986 | 115988 | 10,67€ |
| 35 cl - Théière avec filtre | 1 | 115985 | 115987 | 8,95€ |



| Dimension | Quantité | P.U. |
|------------------------------|----------|----------------------------|
| 22 cl - Tasse à café - par 2 | 10 | 115989 8,58€ |
| 8 cl - Tasse à café - par 2 | 10 | 115990 6,39€ |



| Dimension | Quantité | P.U. |
|----------------------|----------|-----------------------------|
| 24 cl - Irish coffee | 24 | 115991 13,16€ |



| Dimension | Quantité | P.U. |
|------------------|----------|-----------------------------|
| 100 cl - Crémier | 1 | 112586 11,40€ |
| 60 cl - Crémier | 1 | 112585 9,32€ |



| Dimension | Quantité | P.U. |
|--------------------|----------|----------------------------|
| 30 cl - Pot à lait | 1 | 109112 4,61€ |
| 14 cl - Pot à lait | 1 | 109111 3,77€ |



| Dimension | Quantité | P.U. |
|--------------------|----------|-----------------------------|
| 100 cl - Cafetière | 1 | 109105 33,45€ |



| Dimension | Quantité | P.U. |
|-----------------|----------|-----------------------------|
| 60 cl - Théière | 1 | 109102 26,41€ |
| 35 cl - Théière | 1 | 109101 22,53€ |



| Dimension | Quantité | P.U. |
|-------------------|----------|----------------------------|
| 22 cl - Verre thé | 48 | 101134 3,68€ |



| Dimension | Quantité | P.U. |
|----------------------|----------|----------------------------|
| 9 cl - Verre gigogne | 72 | 101009 0,75€ |



| Dimension | Quantité | P.U. |
|------------------------|----------|----------------------------|
| 8,5 cl - Verrecaffèino | 48 | 100517 0,92€ |

LA VAISSELLE

Thé & Café

WELA



| Dimension | | Blanc | Anthracite | Amande | Terracota | P.U. |
|-----------------|----|---------------|---------------|---------------|---------------|--------------|
| 25 cl - Gobelet | 12 | 116000 | 116001 | 116002 | 116003 | 3,85€ |
| 15 cl - Gobelet | 12 | 115996 | 115997 | 115998 | 115999 | 2,74€ |
| 10 cl - Gobelet | 12 | 115992 | 115993 | 115994 | 115995 | 2,34€ |

VIRGO



| Dimension | | P.U. |
|----------------------------------|----|----------------------------|
| Ø 20 cm - Dessert | 12 | 116004 9,42€ |
| 9 cl - Ø 6,5 cm - Ramequin bas | 24 | 116005 2,99€ |
| 12 cl - Ø 6,5 cm - Ramequin haut | 24 | 116006 3,47€ |



| Dimension | | Acacia | P.U. |
|-----------------------------------|---|---------------|---------------|
| 30 x 24 cm - Plateau forme goutte | 1 | 116008 | 22,27€ |
| 20 x 16 cm - Plateau forme goutte | 1 | 116007 | 10,23€ |

Acier inoxydable



| Dimension | | Noir | P.U. |
|--------------------|---|---------------|---------------|
| 60 cl - Pot à lait | 1 | 116013 | 23,37€ |

OVEAL



| Dimension | | Blanc | Noir | P.U. |
|---|---|---------------|---------------|--------------|
| 20 cl - Ø 5,5 x H 8 cm - Tasse à thé | 6 | 102123 | 102124 | 2,48€ |
| 10 cl - Ø 4,5 x H 6,5 cm - Tasse à café | 6 | 102121 | 102122 | 2,04€ |



| Dimension | | P.U. |
|-------------------------------|----|----------------------------|
| 6,5 cl Ø 4 cm - Crémier droit | 6 | 116018 3,33€ |
| 7,5 cl - Crémier | 12 | 101456 2,38€ |



| Dimension | | Blanc | P.U. |
|--------------------|---|---------------|--------------|
| 20 cl - Pot à lait | 6 | 116016 | 3,71€ |
| 12 cl - Pot à lait | 6 | 116015 | 2,14€ |
| 4 cl - Pot à lait | 6 | 116014 | 2,18€ |

LA VAISSELLE

Collectivité

LICORNE



| Dimension | Quantité | Couleur | P.U. |
|--|----------|---------|--------------|
| 30 x 22 x H 2 cm - Plateau 4 compartiments | 6 | Violet | 9,73€ |
| 24 x 21,5 x H 2 cm - Plateau 4 compartiments | 12 | | 5,91€ |
| 21,5 x 21,5 cm - Assiette plate | 12 | | 4,62€ |
| 31 cl - Bol | 12 | | 3,92€ |
| 18 cl - Gobelet | 12 | | 3,42€ |
| Cuillère et fourchette | 12 | | 2,54€ |

LAMA



| Dimension | Quantité | Couleur | P.U. |
|--|----------|---------|--------------|
| 30 x 22 x H 2 cm - Plateau 4 compartiments | 6 | Jaune | 9,73€ |
| 21,5 x 21,5 cm - Assiette plate | 12 | | 4,62€ |
| 31 cl - Bol | 12 | | 3,92€ |
| 18 cl - Gobelet | 12 | | 3,42€ |
| Cuillère et fourchette | 12 | | 2,54€ |



| Dim. | Quantité | Violet | Bleu | Vert | Orange | Tilleul | Rouge | P.U. |
|----------------------------------|----------|---------------|---------------|---------------|---------------|---------------|---------------|--------------|
| 22 cl - Tasse à anses à bec fixe | 12 | 116030 | 116031 | 116032 | 116033 | 116034 | 116035 | 5,82€ |



| Dimension | Quantité | Blanc | Noir | P.U. |
|-----------------------------|----------|---------------|---------------|--------------|
| 70 cl - 15 x 15 cm - Ravier | 10 | 102963 | 102964 | 9,63€ |
| 25 cl - 10 x 10 cm - Ravier | 10 | 102961 | 102962 | 8,42€ |

LA VAISSELLE

Collectivité

COUVERTS ADAPTABLES

5 ans d'études avec des ergothérapeutes, médecins, personnels de santé et patients à mobilité réduite, ont permis de concevoir et mener à terme ces audacieux couverts. Réglables en 3 dimensions. Fabriqués dans un matériau limitant le développement des bactéries. Garantis lave-vaisselle. Embout souple. Ne blesse pas la bouche.



| Dimension | Fourchette | Cuillère | P.U. |
|-------------|-----------------|---------------|---------------|
| ● Vert Anis | 1 203471 | 203468 | 19,76€ |
| ● Orange | 1 203472 | 203469 | 19,76€ |
| ● Framboise | 1 203473 | 203470 | 19,76€ |

COUTEAUX COPOLYESTER



| Dimension | 21 cm | P.U. |
|-----------|------------------|--------------|
| ● Bleu | 12 201938 | 1,60€ |
| ● Vert | 12 201939 | 1,60€ |
| ● Orange | 12 201940 | 1,60€ |
| ● Cassis | 12 201937 | 1,60€ |
| ● Noir | 12 201941 | 1,60€ |



| Dimension | Cuillère 21 cm | Fourchette 21 cm | P.U. |
|-----------|------------------|------------------|--------------|
| ● Bleu | 12 124115 | 124119 | 1,78€ |
| ● Vert | 12 124116 | 124120 | 1,78€ |
| ● Orange | 12 124117 | 124121 | 1,78€ |
| ● Cassis | 12 124118 | 124122 | 1,78€ |

CUILLÈRE ERGO 3D

Cuillère qui s'adapte parfaitement à tout type de morphologie.



| Dimension | Cuillère | P.U. |
|-------------|-----------------|---------------|
| ● Bleu | 1 101566 | 30,60€ |
| ● Framboise | 1 101567 | 30,60€ |
| ● Gris | 1 101568 | 30,60€ |

BOITE COCOON

Cloche de protection articulée et système anti dérapant intégré. Limitant les éventuelles projections. Système antidérapant, limitation des déplacements latéraux de l'assiette.



| Dimension | P.U. |
|---|-------------------------------|
| ø 23 cm assiette copolyester 1 cloche refuge anti dérapante 1 système cocoon clipsable sur l'assiette | 3 114801 52,57€ |

BOITE REFUGE

Ecran de protection limitant les éventuelles projections.



| Dimension | P.U. |
|--------------------------------|-------------------------------|
| Cloche de protection articulée | 3 114800 31,33€ |

LA VAISSELLE

Collectivité



| Dimension | Q | P.U. |
|---------------------|---|----------------------|
| Ø 25 - 27 cm H 7 cm | 1 | 113760 12,81€ |
| Ø 23 - 24 cm H 7 cm | 1 | 113759 11,23€ |



| Dimension | Q | P.U. |
|---------------------|---|----------------------|
| Ø 25 - 27 cm H 7 cm | 1 | 113762 12,88€ |
| Ø 23 - 24 cm H 7 cm | 1 | 113761 11,23€ |

RÉGITHERMIE

Antidérapant - Matière silicone - Résistance aux chocs - Diminue les nuisances sonores - Assure un bon maintien de la température - Très haute résistance à la température (150°C).



| Dimension | Q | P.U. |
|--------------------------------|---|---------------------|
| Ø 23 cm - Assiette demi-creuse | 6 | 123895 8,36€ |



| Dimension | Q | Framboise | Bleu | P,U | Orange | P.U. |
|------------------|---|---------------|---------------|---------------|---------------|---------------|
| Ø 23 cm - Cloche | 3 | 123900 | 123898 | 30,85€ | 123899 | 30,68€ |

HAUTE TEMPÉRATURE

Très haute résistance à la température. Passage au lave-vaisselle et micro-ondes.

| Dimension | Q | Noir | Blanc | Bleu | Orange | P.U. |
|--------------------|---|---------------|---------------|---------------|---------------|--------------|
| Ø 23 cm - Assiette | 6 | 101966 | 101967 | 101968 | 101969 | 8,13€ |
| Ø 23 cm - Cloche | 6 | 101970 | 101971 | 101972 | 101973 | 9,97€ |



THERMODYNAMIQUE

Vaisselle antidérapante pour une stabilité optimale. Fermeture totale du couvercle pour une meilleure sécurité. Système qui ralentit la perte des calories (chaud) et des frigories (froid). Empilable avec ou sans couvercle.



| Dimension | Q | Bleu | Cassis | Orange | Anis | Blanc | P.U. |
|---|---|---------------|---------------|---------------|---------------|---------------|---------------|
| 32 cl - Ø12 x H 6,5 cm - Bol avec couvercle | 6 | 203479 | 203480 | 203481 | 203482 | 203483 | 29,41€ |
| 32 cl - Ø12 x H 6,5 cm - Couvercle pour bol | 6 | 203484 | 203485 | 203486 | 203487 | 203488 | 14,76€ |
| Ø 23 x H 8 cm - Assiette avec couvercle | 6 | 113347 | 113348 | 113350 | 113351 | 113349 | 36,22€ |
| Ø 23 cm - Couvercle pour assiette | 6 | 113352 | 113353 | 113355 | 113356 | 113354 | 18,02€ |



LA VAISSELLE

Collectivité

VAISSELLE SANS BISHPENOL

Grande stabilité grâce à ses 4 pieds. Angles de blocage pour les couvercles. Ultra adhérence.



| Dimension | | Bleu | Jaune | Vert | Blanc | Orange | Cassis | P.U. |
|---------------------------|----|---------------|---------------|---------------|---------------|---------------|---------------|---------------|
| Ø 23 cm - Demi creuse | 30 | 122586 | 122587 | 122588 | 122589 | 122590 | 122591 | 6,58€ |
| Ø 23,5 cm - Antidérapante | 12 | 122592 | - | - | 122595 | 122594 | 122593 | 14,04€ |



| Dimension | | Bleu | Jaune | Vert | Blanc | Orange | Cassis | P.U. |
|----------------------------|----|---------------|---------------|---------------|---------------|---------------|---------------|--------------|
| Ø 18 cm - Assiette plate | 30 | 123023 | 123024 | 123025 | 123026 | 123028 | 123027 | 4,31€ |
| Ø 13,4 cm - Assiette plate | 30 | 123017 | 123018 | 123019 | 123020 | 123022 | 123021 | 3,50€ |



| Dimension | | Bleu | Jaune | Vert | Blanc | Orange | Cassis | P.U. |
|--|----|---------------|---------------|---------------|---------------|---------------|---------------|--------------|
| 10 cl - Comptoir | 48 | 123011 | 123012 | 123013 | 123014 | 123016 | 123015 | 3,48€ |
| 32 cl - 14,7 x 9 x 3 cm - Ravier rectangulaire | 48 | 123005 | 123006 | 123007 | 123008 | 123010 | 123009 | 5,06€ |
| 25 cl - 9,7 x 9,7 x 3 cm - Ravier carré | 48 | 123808 | 123809 | 123810 | 123811 | 123812 | 123813 | 4,31€ |
| 16 cl - Ramequin | 48 | 122999 | 123000 | 123001 | 123002 | 123004 | - | 3,57€ |
| 21 cl - Ramequin | 48 | - | - | - | - | - | 123003 | 3,57€ |



| Dimension | | Bleu | Jaune | Vert | Blanc | Orange | Cassis | P.U. |
|-------------------------------|----|---------------|---------------|---------------|---------------|---------------|---------------|--------------|
| 45 cl - Bol | 25 | 122789 | 122790 | 122971 | 122972 | 122974 | 122973 | 4,99€ |
| Ø 12,3 cm - 45 cl - Couvercle | 25 | 122975 | 122976 | 123977 | 123978 | 122980 | 122979 | 2,14€ |



| Dimension | | Bleu | Jaune | Vert | Orange | Cassis | Transparent | P.U. |
|-------------------------|----|---------------|---------------|---------------|---------------|---------------|---------------|--------------|
| 16 cl - Verre empilable | 50 | 122993 | 122994 | 122995 | 122997 | 122998 | 122996 | 2,20€ |
| 20 cl - Verre empilable | 50 | 122987 | 122988 | 122989 | 122991 | 122992 | 122990 | 2,36€ |



| Dimension | | Bleu | Blanc | Orange | Cassis | P.U. |
|------------------------------|----|---------------|---------------|---------------|---------------|--------------|
| 27 cl - Tasse | 12 | 123031 | 123034 | 123033 | 123032 | 6,13€ |
| 27 cl - Tasse avec couvercle | 12 | 123035 | - | 123037 | 123036 | 8,31€ |



LA VAISSELLE

Collectivité

LILITOUCH / LILIROC

Surface grainée – Bosse de séchage – Résistance 70 à 80 ° C



| Dimension | | Bleu | Blanc | Rouge | Alpage | P.U. |
|----------------------------|----|--------|--------|--------|--------|-------|
| Ø 13,4 cm - Assiette plate | 15 | 102855 | 102856 | 102854 | - | 3,89€ |
| Ø 18 cm - Assiette plate | 15 | 102852 | 102853 | 102851 | 103744 | 4,76€ |
| Ø 20 cm - Assiette carrée | 15 | 102858 | 102859 | 102857 | - | 7,41€ |
| Ø 23 cm - Assiette plate | 15 | 102849 | 102850 | 102848 | 103743 | 7,27€ |



| Dimension | | Bleu | Blanc | Rouge | P.U. |
|--|----|--------|--------|--------|--------|
| 32,5 x 26,5 cm - Plateau gastronomique GNI/2 | 15 | 102873 | 102874 | 102872 | 16,50€ |



| Dimension | | Bleu | Blanc | Rouge | Alpage | P.U. |
|---|----|--------|--------|--------|--------|-------|
| 25 cl - L 11 cm - P 3 cm - Ravier carré | 24 | 102876 | 102877 | 102875 | 103747 | 4,81€ |
| 32 cl - L 14,7 cm - P 3 cm - Ravier rectangle | 24 | 102879 | 102880 | 102878 | 103748 | 5,69€ |



| Dimension | | Bleu | Blanc | Rouge | Alpage | P.U. |
|---------------|----|--------|--------|--------|--------|-------|
| 16 cl - Verre | 18 | 102864 | 102865 | 102863 | 103745 | 2,41€ |
| 20 cl - Verre | 18 | 102861 | 102862 | 102860 | - | 2,58€ |



| Dimension | | Bleu | Blanc | Rouge | Alpage | P.U. |
|---|----|--------|--------|--------|--------|-------|
| 10 cl - L 12 cm - P 3,3 cm - Compotier | 24 | 102884 | 102885 | 102883 | 103749 | 3,84€ |
| 16 cl - L 8,6 cm - P 4,1 cm - Ramequin de service | 24 | 102887 | 102888 | 102886 | 103750 | 4,00€ |

| Dimension | | P.U. |
|---------------------------------|----|--------------|
| Couvercle pour ravier rectangle | 48 | 102882 1,40€ |
| Couvercle pour ravier carré | 48 | 102881 1,19€ |
| Couvercle pour ramequin 16 cl | 48 | 102889 1,13€ |



| Dimension | | Bleu | Blanc | Rouge | Alpage | P.U. |
|-------------------------------------|----|--------|--------|--------|--------|-------|
| 20 cl - H 8 cm - Ø 7 cm - Mug-Tasse | 12 | 102870 | 102871 | 102869 | - | 3,34€ |
| 45 cl - H 6 cm - Ø 12 cm - Bol | 12 | 102867 | 102868 | 102866 | 103746 | 5,51€ |

LA VAISSELLE

Collectivité



VAISSELLE POLYPROPYLENE

Le polypropylène est un polymère alimentaire semi-rigide. Sa matière est douce et non agressive. Toute la gamme est fabriquée en France. Micro-ondable, 0 % BPA (Bisphenol A).



Dimension

- Ø 18,5 cm - Assiette creuse
- 50 cl - Bol à oreilles
- 35 cl - Bol à oreilles
- 16 cl - Gobelet avec rebord
- 15 cl - Gobelet avec rebord

| | Bleu lagon | Agrumes | Menthe | Grenadine | P.U. |
|----|---------------|---------------|---------------|---------------|--------------|
| 12 | 113202 | 113203 | 113204 | 113205 | 2,40€ |
| 12 | 101561 | 101562 | 101563 | 101565 | 3,62€ |
| 12 | 113210 | 113211 | 113212 | 113213 | 2,28€ |
| 24 | 101554 | 101556 | 101555 | 101552 | 1,74€ |
| 12 | 113206 | 113207 | 113208 | 113209 | 1,63€ |



LA VAISSELLE

Collectivité



VAISSELLE COPOLYESTER

Le copolyester est un matériau recyclable et incassable. Il supporte le micro-ondes et passe au lave-vaisselle. La gamme en copolyester est entièrement fabriquée en France.



| Dimension | ● | ● | ● | ● | ● | ○ | ● | ○ | P.U. |
|--|------------|---------|---------|--------|-----------|--------|--------|-------------|-------|
| | Bleu lagon | Agrumes | Tilleul | Menthe | Grenadine | Blanc | Violet | Transparent | |
| Ø 12 x H 7 cm - 50 cl - Bol oreilles | 24 108390 | 108389 | 124176 | 124177 | 124179 | 124175 | 124178 | - | 4,02€ |
| Ø 6,3 x H 8,5 cm - 16 cl - Gobelet empilable | 24 108392 | 108391 | 112807 | 112806 | 124212 | 124210 | 124211 | 112808 | 2,11€ |
| 15 x 9,5 x H 3,2 cm - 30 cl - Ravier | 24 108382 | 108381 | 124181 | 124182 | 124184 | 124180 | 124183 | - | 3,26€ |
| Ø 7 x H 9 cm - 20 cl - Gobelet empilable | 24 112809 | 112810 | 112812 | 112811 | 124215 | 124213 | 124214 | 112813 | 2,42€ |



LA VAISSELLE

Collectivité



Surface grainée anti-rayures. Bec verseur anti-gouttes, sans phtalate.

| Dimension | | Bleu | Vert | Orange | Jaune | Cassis | Transparent | P.U. |
|------------------------|---|--------|--------|--------|--------|--------|-------------|--------|
| 50 cl - Avec couvercle | 7 | 122627 | 122629 | 122631 | 122628 | 122632 | 122630 | 11,52€ |

Base antidérapante. Empilable avec couvercle. Bec verseur à régulation, anti-goutte.

| Dimension | | Bleu | Orange | Cassis | Transparent | P.U. |
|------------------------|---|--------|--------|--------|-------------|--------|
| 50 cl - Avec couvercle | 4 | 123130 | 123132 | 123131 | 123133 | 13,05€ |

Avec bec verseur

| Dimension | | Rouge | Bleu | Blanc | P.U. |
|--|----|--------|--------|--------|--------|
| 100 cl - Ø 10,4 x H 17 cm - Sans couvercle | 8 | 101590 | 101591 | 101592 | 12,22€ |
| 100 cl - Ø 10,4 x H 17 cm - Avec couvercle | 7 | 102890 | 102891 | 102892 | 14,68€ |
| 100 cl - Couvercle pour pichet | 24 | 101594 | 101595 | 101596 | 3,64€ |



| Dimension | | Bleu | Vert | Orange | Jaune | Cassis | Transparent | P.U. |
|--|---|--------|--------|--------|--------|--------|-------------|--------|
| 150 cl - Ø 12,3 x H 22,4 cm - Sans couvercle | 8 | 123901 | 123903 | 123906 | 123902 | 123905 | 123904 | 13,24€ |
| 100 cl - Avec couvercle | 7 | 101986 | 101987 | 101988 | 101989 | 101990 | 101991 | 15,68€ |
| 150 cl - Avec couvercle | 7 | 101992 | 101993 | 101994 | 101995 | 101996 | 101997 | 19,31€ |
| 100 cl - Ø 12 x H 19,3 cm - Sans couvercle | 8 | 123919 | 123921 | 123924 | 123920 | 123923 | 123922 | 11,23€ |



| Dimension | | Bleu | Vert | Orange | Jaune | P.U. |
|-------------------------|---|--------|--------|--------|--------|--------|
| 100 cl - Avec couvercle | 7 | 108063 | 108067 | 122625 | 122626 | 15,68€ |
| 150 cl - Avec couvercle | 7 | 108062 | 108066 | 122623 | 122624 | 19,31€ |



PICHET CONTAINER ISOTHERME

Maintien en température, maximum supporté : 80°C. Robinet en polypropylène. Multiples poignées de transport et manipulation facile. Livré avec 2 robinets dont 1 spécial potage. Démontage et nettoyage rapide du robinet. Dimensions : Ø,24 cm, profondeur 26 cm et hauteur 51 cm. Le couvercle ne passe pas au lave-vaisselle.



| Dimension | | Bleu | Orange | Cassis | P.U. |
|-----------|---|--------|--------|--------|---------|
| Ø 500 cl | 1 | 101586 | 101588 | 101587 | 261,95€ |



POLYPROPYLENE



| Dimension | Bleu lagon | Agrumes | Menthe | P.U. Grenadine | P.U. Violet | Blanc | Tilleul | Transparent | P.U. | | |
|---|------------|---------|--------|----------------|-------------|-------|---------|-------------|--------|--------|-------|
| 150 cl - Ø 12,5 x H 19 cm - Pichet | 6 122611 | 122612 | 122613 | 5,69€ | 122614 | 5,69€ | 101679 | 101680 | 101681 | 101682 | 6,53€ |
| 100 cl - Ø 11 x H 16 cm - Pichet | 6 112772 | 112773 | 112774 | 3,93€ | 101674 | 4,21€ | 101675 | 101676 | 101677 | 101678 | 4,21€ |
| 50 cl - 11 x H 11 cm - Pichet empilable | 6 115384 | 115386 | 115385 | 4,16€ | 115389 | 4,16€ | 115383 | 115387 | 115388 | 115382 | 4,16€ |
| 150 cl - Couverture pichet | 6 122619 | 122620 | 122621 | 1,93€ | 122622 | 1,93€ | 101684 | 101685 | 101683 | 101686 | 2,22€ |
| 100 cl - 50 cl - Couverture pichet | 6 101687 | 101694 | 101692 | 1,91€ | 101693 | 1,91€ | 101689 | 101690 | 101688 | 101691 | 1,91€ |

COPOLYESTER



| Dimension | Bleu lagon | Agrumes | Menthe | Tilleul | Transparent | P.U. Grenadine | P.U. Violet | Blanc | P.U. | |
|--|------------|---------|--------|---------|-------------|----------------|-------------|--------|--------|--------|
| 150 cl - Ø 11 x H 16 cm - Sans couvercle | 6 122599 | 122600 | 122598 | 122597 | 122596 | 11,17€ | 101571 | 101569 | 101570 | 12,91€ |
| 100 cl - Ø 11 x H 16 cm - Sans couvercle | 6 112777 | 112778 | 112779 | 112780 | 112776 | 9,19€ | 101574 | 101572 | 101573 | 9,37€ |
| 50 cl - 11 x H 11 cm - Pichet sans couvercle | 6 115392 | 115394 | 115393 | 115396 | 115390 | 8,01€ | 115397 | 115391 | 115395 | 8,01€ |
| 150 cl - Couverture pichet | 6 122607 | 122608 | 122609 | 122610 | 122606 | 2,40€ | 101584 | 101583 | 101585 | 2,79€ |
| 100 cl - 50 cl - Couverture pichet | 6 101576 | 101577 | 101578 | 101579 | 101575 | 2,39€ | 101581 | 101580 | 101582 | 2,39€ |

PLASTIQUE



| Dimension | Blanc | Azur | P.U. |
|-----------|----------|--------|-------|
| 150 cl | 6 108150 | 108151 | 6,38€ |

CARAFE AVEC COUVERCLE



| Dimension | Copolyester | P.U. |
|------------------|-------------|--------|
| 100 cl - 24,8 cm | 12 108100 | 11,63€ |
| 50 cl - 20 cm | 12 108050 | 8,53€ |
| 25 cl - 15,9 cm | 12 108025 | 5,13€ |



| Dimension | P.U. |
|-----------|-----------------|
| 200 cl | 1 109212 20,32€ |
| 150 cl | 1 109211 18,27€ |
| 100 cl | 1 109210 15,20€ |



SIDE PVD NOIR

| Inox 18/10 - ép. 3.5 mm | | | P.U |
|-------------------------|---|---------------|---------------|
| Fourchette de table | 1 | 116047 | 9,23€ |
| Cuillère de table | 1 | 116048 | 9,97€ |
| Cuillère à café | 1 | 116049 | 6,62€ |
| Couteau de table | 1 | 116050 | 11,14€ |
| Fourchette à dessert | 1 | 116051 | 8,73€ |
| Cuillère à dessert | 1 | 116052 | 9,25€ |
| Couteau à dessert | 1 | 116053 | 10,29€ |



JEWEL

| Inox 18/10 - ép. 3 mm | | | P.U |
|-----------------------|----|---------------|--------------|
| Couteau de table | 12 | 103689 | 4,31€ |
| Fourchette de table | 12 | 103690 | 3,38€ |
| Cuillère de table | 12 | 103691 | 3,38€ |
| Couteau à dessert | 12 | 103692 | 4,10€ |
| Fourchette à dessert | 12 | 103693 | 3,23€ |
| Cuillère à dessert | 12 | 103694 | 3,23€ |
| Cuillère à café | 12 | 103695 | 2,47€ |
| Cuillère à moka | 12 | 103696 | 2,38€ |



DANUBE

| Inox 18/0 - ép. 2 mm | | | P.U |
|----------------------|---|---------------|--------------|
| Fourchette table | 1 | 116036 | 1,18€ |
| Cuillère table | 1 | 116037 | 1,18€ |
| Cuillère café | 1 | 116038 | 0,82€ |
| Couteau table | 1 | 116039 | 1,79€ |
| Fourchette dessert | 1 | 116040 | 1,13€ |
| Cuillère dessert | 1 | 123992 | 1,12€ |
| Couteau dessert | 1 | 123993 | 2,53€ |



PRISMA AMANDE

| Inox 18/0 - ép. 2 mm | | | P.U |
|----------------------|---|---------------|--------------|
| Fourchette table | 1 | 116043 | 1,73€ |
| Cuillère table | 1 | 116044 | 1,73€ |
| Cuillère café | 1 | 116045 | 1,44€ |
| Couteau table | 1 | 116046 | 1,76€ |

Autre coloris disponible ● Gris ● Noir ● Framboise

LES COUVERTS



NEUVIEME ART

| Inox 18/10 - ép. 4 mm | Q | P.U |
|-----------------------|------------------|---------------|
| Couteau de table | 12 103712 | 7,78€ |
| Fourchette de table | 12 103713 | 5,69€ |
| Cuillère table | 12 103714 | 5,69€ |
| Couteau à poisson | 12 103715 | 5,69€ |
| Fourchette à poisson | 12 103716 | 5,69€ |
| Couteau à dessert | 12 103717 | 7,42€ |
| Fourchette à dessert | 12 103718 | 5,44€ |
| Cuillère à dessert | 12 103719 | 5,44€ |
| Fourchette de service | 1 103720 | 15,96€ |
| Cuillère de service | 1 103721 | 15,96€ |
| Fourchette à gâteau | 12 103723 | 4,15€ |
| Cuillère à café | 12 103724 | 3,94€ |
| Cuillère à expresso | 12 103725 | 3,75€ |



HAIKOU

| Inox 18/10 - ép. 3,5 mm | Q | P.U |
|-------------------------|------------------|---------------|
| Couteau de table | 12 103726 | 6,44€ |
| Fourchette de table | 12 103727 | 3,84€ |
| Cuillère de table | 12 103728 | 3,84€ |
| Couteau à dessert | 12 103729 | 6,14€ |
| Fourchette à dessert | 12 103730 | 3,66€ |
| Cuillère à dessert | 12 103731 | 3,66€ |
| Fourchette de service | 12 103732 | 10,80€ |
| Cuillère de service | 12 103733 | 10,80€ |
| Cuillère à café | 12 103734 | 2,88€ |



HAVANE

| Inox 18/0 - ép. 3 mm | Q | P.U |
|----------------------|-----------------|--------------|
| Couteau steak | 1 100066 | 2,66€ |
| Couteau table | 1 100061 | 2,66€ |
| Fourchette table | 1 100058 | 1,81€ |
| Cuillère table | 1 100059 | 1,81€ |
| Couteau dessert | 1 100064 | 2,53€ |
| Fourchette dessert | 1 100062 | 1,71€ |
| Cuillère dessert | 1 100063 | 1,71€ |
| Cuillère café | 1 100060 | 0,85€ |
| Cuillère moka | 1 100065 | 0,81€ |



SOPRANO

| Inox 18/0 - ép. 4 mm | Q | P.U |
|---------------------------|-----------------|--------------|
| Fourchette de table | 1 116063 | 1,98€ |
| Cuillère de table | 1 116064 | 1,98€ |
| Cuillère à café / dessert | 1 116065 | 1,40€ |
| Couteau de table | 1 116066 | 3,03€ |

LES COUVERTS



La gamme de couverts ROCCO est profonde et se marie élégamment avec toutes les collections d'assiettes. Fabrication européenne.



ROCCO

| Inox 18/10 - ép.3 m | ☛ | P.U |
|----------------------|-----------|--------|
| Couteau à steak | 12 114429 | 6,88€ |
| Couteau de table | 12 114430 | 5,92€ |
| Fourchette de table | 12 114431 | 4,54€ |
| Cuillère de table | 12 114432 | 4,54€ |
| Couteau à poisson | 12 114433 | 3,66€ |
| Fourchette à poisson | 12 114434 | 3,66€ |
| Couteau à dessert | 12 114435 | 5,14€ |
| Fourchette à dessert | 12 114436 | 3,30€ |
| Cuillère à dessert | 12 114437 | 3,41€ |
| Service à salade | 3 114438 | 15,17€ |
| Cuillère à glace | 12 114439 | 2,78€ |
| Cuillère à café | 12 114440 | 2,96€ |
| Cuillère à moka | 12 114441 | 2,34€ |

LAGUIOLE

| Inox 18/10 - ép.1,5 m | ☛ | P,U |
|-----------------------|-----------|--------|
| Couteau | 12 114442 | 4,24€ |
| Fourchette | 12 114443 | 3,58€ |
| Cuillère | 12 114444 | 3,58€ |
| Couteau de fromage | 6 114445 | 7,00€ |
| Pelle à tarte | 6 114446 | 12,62€ |
| Cuillère à glace | 6 114447 | 6,11€ |
| Cuillère à café | 12 114448 | 3,06€ |
| Cuillère à moka | 12 114449 | 3,06€ |
| Inox 18/10 - ép.1,5 m | ☛ | P,U |
| Service à fromage | 2 114529 | 21,28€ |
| Fromagette | 6 114530 | 4,49€ |
| Tartineur | 6 114531 | 4,49€ |
| Service à découper | 2 114532 | 18,95€ |
| Service à salade | 2 114533 | 17,16€ |
| Couteau à pain | 6 114534 | 9,97€ |



THAI BRILLANT

| Inox 18/0 | ☛ | P.U |
|---------------------|-----------|-------|
| Couteau de table | 12 115407 | 2,96€ |
| Fourchette de table | 12 115408 | 2,96€ |
| Cuillère de table | 12 115409 | 2,96€ |
| Cuillère à café | 12 115410 | 2,35€ |

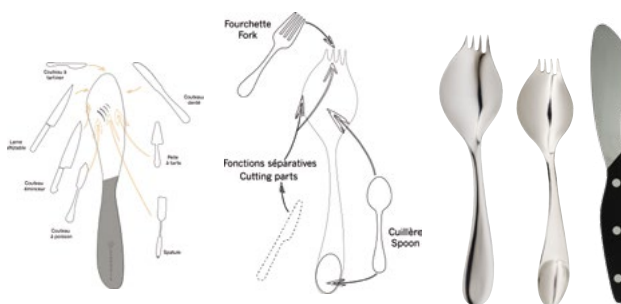

2 couverts et demi en 1 ! Une cuillère, une fourchette et un couteau en un seul couvert : tel est le concept de cet outil original. Le bord affilé de Georgette® est suffisamment fin pour trancher la plupart des aliments. Savourer en une même bouchée les aliments solides avec leur sauce et leur accompagnement, apprécier l'association d'arômes et de textures, c'est ce que permet Georgette®. Un plaisir pour le palais !

GEORGETTE

| Inox 18/10 | ☛ | P.U |
|---|-----------|--------|
| Unik - 19 cm | 20 114808 | 6,51€ |
| Demoiselle - 16 cm (Droitier) | 24 114810 | 14,36€ |
| Lunch | 24 114807 | 6,21€ |
| Standing - 19 cm (Droitier) | 24 114809 | 15,08€ |
| George - Couteau biface double lame - 22,3 cm | 12 116067 | 34,66€ |



SANGIOVESE Q19

Inox 18/10 - ép. 3,5 mm

| | Q | P,U |
|----------------------|---|---------------------|
| Fourchette à gâteau | 1 | 114889 1,82€ |
| Cuillère à café | 1 | 114890 1,65€ |
| Couteau à dessert | 1 | 114886 2,91€ |
| Fourchette de table | 1 | 114882 2,94€ |
| Cuillère de table | 1 | 114883 2,94€ |
| Couteau à poisson | 1 | 114884 2,42€ |
| Fourchette à poisson | 1 | 114885 2,26€ |
| Fourchette à dessert | 1 | 114887 2,26€ |
| Cuillère à dessert | 1 | 114888 2,26€ |
| Couteau de table | 1 | 114881 3,94€ |
| Cuillère à moka | 1 | 114891 1,10€ |



ROSEWOOD

Inox 18/10 - ép. 2,5 mm

| | Q | P,U |
|---------------------|---|---------------------|
| Cuillère à café | 1 | 116084 4,14€ |
| Couteau à steak | 1 | 116085 3,60€ |
| Cuillère de table | 1 | 116086 4,56€ |
| Fourchette de table | 1 | 116087 4,70€ |



FLEUR DE LYS

Inox 18/10 - ép. 4.5 mm

| | Q | P,U |
|----------------------|---|---------------------|
| Couteau de table | 1 | 116075 3,94€ |
| Fourchette de table | 1 | 116074 3,38€ |
| Cuillère de table | 1 | 116076 3,38€ |
| Couteau à dessert | 1 | 116071 3,28€ |
| Fourchette à dessert | 1 | 116070 2,83€ |
| Fourchette à gâteau | 1 | 116068 1,89€ |
| Cuillère à dessert | 1 | 116072 2,83€ |
| Cuillère à café | 1 | 116069 1,89€ |
| Cuillère à moka | 1 | 116073 1,57€ |



OAK

Inox 18/10

| | Q | P,U |
|---------------------|---|---------------------|
| Fourchette à gâteau | 1 | 116077 1,98€ |
| Couteau à gâteau | 1 | 116078 1,98€ |
| Cuillère à café | 1 | 116079 1,97€ |
| Cuillère à moka | 1 | 116080 1,41€ |
| Fourchette de table | 1 | 116081 2,58€ |
| Couteau de table | 1 | 116082 2,62€ |
| Cuillère de table | 1 | 116083 2,58€ |



HOTEL

| Inox 18/0 | 📦 | | P.U |
|----------------------|---|---------------|--------------|
| Couteau de table | 1 | 116088 | 1,28€ |
| Fourchette de table | 1 | 116090 | 0,50€ |
| Cuillère de table | 1 | 116089 | 0,50€ |
| Couteau à dessert | 1 | 116091 | 1,25€ |
| Fourchette à dessert | 1 | 116093 | 0,46€ |
| Cuillère à dessert | 1 | 116092 | 0,46€ |
| Cuillère à café | 1 | 116094 | 0,32€ |
| Cuillère à moka | 1 | 116095 | 0,29€ |



CHEESE

| Inox 18/0 - ép. 3 mm | 📦 | | P.U |
|----------------------|---|---------------|--------------|
| Couteau à steak | 1 | 123976 | 2,05€ |
| Cuillère de table | 1 | 123977 | 1,28€ |
| Fourchette de table | 1 | 123978 | 1,28€ |
| Couteau à dessert | 1 | 123979 | 1,95€ |
| Cuillère à dessert | 1 | 123980 | 1,22€ |
| Fourchette à dessert | 1 | 123981 | 1,22€ |
| Cuillère à café | 1 | 123982 | 0,75€ |
| Cuillère à moka | 1 | 123984 | 0,70€ |



SANTORINI

| Inox 18/0 - ép. 3,5 mm | 📦 | | P.U |
|------------------------|---|---------------|--------------|
| Couteau de table | 1 | 116104 | 2,43€ |
| Cuillère de table | 1 | 116105 | 1,52€ |
| Fourchette de table | 1 | 116106 | 1,52€ |
| Cuillère à café | 1 | 116107 | 0,88€ |
| Cuillère à moka | 1 | 116108 | 0,82€ |
| Couteau à dessert | 1 | 116109 | 2,08€ |
| Cuillère à dessert | 1 | 116110 | 1,09€ |
| Fourchette à dessert | 1 | 116111 | 1,09€ |



CANADA

| Inox 18/0 - ép. 4 mm | 📦 | | P.U |
|----------------------|---|---------------|--------------|
| Couteau de table | 1 | 116112 | 2,02€ |
| Cuillère de table | 1 | 116113 | 1,55€ |
| Fourchette de table | 1 | 116114 | 1,55€ |
| Couteau à dessert | 1 | 116115 | 1,90€ |
| Cuillère à dessert | 1 | 116116 | 1,18€ |
| Fourchette à dessert | 1 | 116117 | 1,18€ |
| Cuillère à café | 1 | 116118 | 0,93€ |
| Cuillère à moka | 1 | 116119 | 0,78€ |



KODAI VINTAGE NOIR

| Inox 18/0 | 📦 | | P.U |
|--------------------------------|---|---------------|--------------|
| Couteau de table | 1 | 116153 | 4,18€ |
| Cuillère de table | 1 | 116154 | 3,39€ |
| Fourchette de table - 2 piques | 1 | 116155 | 3,39€ |
| Fourchette de table - 3 piques | 1 | 116156 | 3,39€ |
| Cuillère à café | 1 | 116160 | 2,93€ |
| Cuillère à moka | 1 | 116161 | 3,17€ |

Autre coloris disponible ● Gold

LES COUVERTS



ATLANTIDA

| Inox 18/10 - ép. 6 mm | ◆ | | P.U |
|-----------------------|---|---------------|--------------|
| Couteau de table | 1 | 116120 | 4,19€ |
| Cuillère de table | 1 | 116121 | 4,54€ |
| Fourchette de table | 1 | 116122 | 4,62€ |
| Couteau à gâteau | 1 | 116123 | 3,78€ |
| Fourchette à gâteau | 1 | 116124 | 3,31€ |
| Cuillère à gâteau | 1 | 116125 | 3,26€ |
| Cuillère à moka | 1 | 116126 | 1,78€ |



NORTH XL

| Inox 18/10 - ép. 3 mm | ◆ | | P.U |
|-----------------------|---|---------------|--------------|
| Couteau à steak | 1 | 113971 | 2,56€ |
| Fourchette à steak | 1 | 113972 | 2,29€ |
| Couteau de table | 1 | 113973 | 2,56€ |
| Fourchette de table | 1 | 113975 | 2,30€ |
| Cuillère de table | 1 | 113974 | 2,30€ |
| Couteau à poisson | 1 | 113976 | 2,06€ |
| Fourchette à poisson | 1 | 113977 | 2,21€ |
| Couteau à dessert | 1 | 116134 | 2,27€ |
| Fourchette à dessert | 1 | 116136 | 1,98€ |
| Cuillère à dessert | 1 | 113978 | 1,98€ |
| Cuillère à thé | 1 | 116137 | 1,31€ |
| Cuillère à café | 1 | 113979 | 1,26€ |
| Cuillère à moka | 1 | 113980 | 1,12€ |



ECO

| Inox 18/0 | ◆ | | P.U |
|----------------------|---|---------------|--------------|
| Couteau de table | 1 | 102004 | 0,56€ |
| Cuillère de table | 1 | 102001 | 0,35€ |
| Fourchette de table | 1 | 102002 | 0,35€ |
| Cuillère à dessert | 1 | 102033 | 0,34€ |
| Fourchette à dessert | 1 | 102034 | 0,34€ |
| Cuillère à café | 1 | 102003 | 0,19€ |
| Cuillère à moka | 1 | 102036 | 0,16€ |



LOTUS FREE

| Inox 18/0 - ép. 3,5 mm | ◆ | | P.U |
|------------------------|---|---------------|--------------|
| Cuillère à dessert | 1 | 116147 | 1,17€ |
| Fourchette à dessert | 1 | 116148 | 1,17€ |
| Cuillère à moka | 1 | 116149 | 0,88€ |
| Cuillère de table | 1 | 116150 | 1,36€ |
| Fourchette de table | 1 | 116151 | 1,36€ |
| Cuillère à café | 1 | 116152 | 0,96€ |

LES COUVERTS

Couteaux spéciaux

LE THIERS

Lame lisse pleine soie.



Dimension P.U.
2 mm - Bois olivier 12 **114459** **19,43€**

STAND UP

Lame micro-dentelé pleine soie.



Dimension P.U.
1,2 mm - ABS noir 12 **114454** **6,74€**

LE THIERS

Lame lisse pleine soie.



Dimension P.U.
2 mm - Noir mat 12 **114460** **21,52€**

STAND UP

Lame micro-dentelé pleine soie.



Dimension P.U.
1,2 mm - ABS blanc 12 **114455** **6,74€**

NEW AGE

Lame micro-dentelé avec traitement PVD, pleine soie.



Dimension P.U.
1,2 mm - Noir 12 **114456** **10,28€**

BISTRONOMIE

Lame 10 cm lisse satinée, pleine soie.



Dimension P.U.
2 mm - Mitre inox 12 **115436** **28,20€**

STYL'UP

Monobloc - Inox 18/0



Dimension P.U.
Long. lame 26 cm 12 **114457** **2,76€**

VINTAGE

Lame inox micro dentée demi soie.



Dimension P.U.
0,8 mm - Noir 12 **114458** **114458**

COUTEAU STEAK

Manche comprimé bois



Dimension P.U.
Long. lame 11 cm -
Lame lisse 12 **101776** **5,47€**

COUTEAU STEAK

Manche comprimé bois



Dimension P.U.
Long. lame 11 cm -
Lame micro-dentelé 12 **102510** **3,66€**

COUTEAU STEAK

Inox



Dimension P.U.
Lame lisse 12 **102511** **6,73€**

COUTEAU STEAK



Dimension P.U.
Forgé monobloc
cranté 12 **114831** **4,67€**

COUTEAU STEAK

Inox



Dimension P.U.
Forgé monobloc cranté 12 **114135** **3,82€**

COUTEAUX STEAK

Boîte de 12



Dimension P.U.
Bout rond 2 rivets 1 **115955** **8,10€**



LES COUVERTS

Couteaux spéciaux

REFLEX

Lame microdentée - manche polypro



| Dimension | | P.U |
|---------------------------|-----------------|---------------|
| Long. lame 12 cm - par 24 | 1 102222 | 13,50€ |

CORTA PIZZ

Lame i inox, manche polymère



| Dimension | | P.U |
|--------------------|------------------|--------------|
| Long. lame 11,5 cm | 12 102209 | 4,37€ |

EVOLUTION

Lame microdentée, manche polypropylène



| Dimension | | P.U |
|------------------|-----------------|--------------|
| Long. lame 12 cm | 1 202306 | 3,53€ |

JUMBO



| | | P.U |
|----------------------|-----------------|--------------|
| Couteau pizza - Noir | 1 122721 | 3,18€ |

RESTO



| Boîte de 12 | | P.U |
|------------------------------|-----------------|---------------|
| Couteaux de table microdenté | 1 102508 | 13,26€ |

ALPHONSE



| Inox 13/0 | | P.U |
|---------------------------------|------------------|---------------|
| Long. Couteau 23,4 cm - Ecorce | 12 114827 | 11,69€ |
| Long. Couteau 23,5 cm - Abeille | 12 114828 | 11,69€ |

TORINO

Acier inox 420



| Dimension | | P.U |
|---------------|-----------------|--------------|
| Long. lame 23 | 1 101774 | 7,66€ |

VIRGULE



| Dimension | | P.U |
|---------------|-----------------|--------------|
| Couteau steak | 1 102119 | 4,03€ |

FUSION



| | | P.U |
|---------------|-----------------|--------------|
| Couteau steak | 1 124320 | 8,50€ |

SERIE 197



| Dimension | | P.U |
|--------------------|-----------------|--------------|
| Long. lame 11,5 cm | 1 114814 | 5,43€ |

TOLEDO



| Dimension | | P.U |
|---------------------|------------------|--------------|
| Lame crantée - Bleu | 12 114830 | 4,17€ |
| Lame crantée - Bois | 12 114829 | 4,17€ |

ACHILLE



| Dimension | | P.U |
|----------------------|-----------------|--------------|
| Couteau steak - Bois | 1 116096 | 8,45€ |
| Couteau steak - Noir | 1 116097 | 8,33€ |

ACONCAGUA

Acier inox 420



| Dimension | | P.U |
|---------------------------|-----------------|---------------|
| Long. lame 25,8 cm - Noir | 1 115952 | 11,14€ |
| Long. lame 25,8 cm - Bois | 1 115953 | 11,14€ |

MONTBLANC

Acier inox 420



| Dimension | | P.U |
|-------------------------|-----------------|---------------|
| Long. lame 23 cm - Bois | 1 116041 | 53,28€ |
| Long. lame 23 cm - Noir | 1 116042 | 8,24€ |



LA VERRERIE

Verre à pied



FLORIAN

Collection de verres à pied avec un design qui mixte Art Déco strié et floral.

| Dimension | Q | | P.U |
|----------------------------|---|---------------|--------------|
| 53,5 cl - Verre à vin | 6 | 115452 | 5,87€ |
| 38 cl - Verre à vin | 6 | 115453 | 5,60€ |
| 24,5 cl - Verre à cocktail | 6 | 115454 | 4,67€ |
| 24 cl - Coupe | 6 | 115455 | 5,58€ |
| 21 cl - Verre à prosecco | 6 | 115451 | 4,65€ |



SUBLYM

| Dimension | Q | | P.U |
|-------------------------------|----|---------------|--------------|
| 55 cl - Ø 9,2 x H 26 cm | 12 | 101383 | 4,10€ |
| 45 cl - Ø 8,7 x H 25 cm | 12 | 101384 | 3,74€ |
| 35 cl - Ø 8 x H 23 cm | 24 | 101385 | 3,74€ |
| 25 cl - Ø 7,2 x H 20,7 cm | 24 | 101386 | 3,59€ |
| 21 cl - Ø 7 x H 24 cm - Flûte | 24 | 101387 | 3,96€ |



COSY MOMENTS

Set de 6

| Dimension | Q | | P.U |
|---------------------------------|---|---------------|---------------|
| 36 cl - Verre à vin - par 6 | 1 | 116098 | 14,72€ |
| 48 cl - Verre à vin - par 6 | 1 | 116099 | 14,72€ |
| 34 cl - Gobelet FB - par 6 | 1 | 116100 | 10,28€ |
| 36 cl - Gobelet FH - par 6 | 1 | 116101 | 10,28€ |
| 70 cl - Verre cocktail - par 6 | 1 | 116102 | 16,43€ |
| 19 cl - Verre champagne - par 6 | 1 | 116103 | 14,67€ |



NÉO

| Dimension | Q | | P.U |
|----------------------|----|---------------|--------------|
| 25 cl - Verre à pied | 24 | 115506 | 2,08€ |
| 40 cl - Verre à pied | 24 | 115507 | 2,15€ |
| 50 cl - Verre à pied | 24 | 115508 | 2,40€ |
| 20 cl - Flûte | 24 | 115509 | 2,15€ |



VITICOLE

Verre non trempé

| Dimension | Q | | P.U |
|----------------------|----|---------------|--------------|
| 31 cl - 7,2 x 17,5 | 6 | 116177 | 2,84€ |
| 21,5 cl - 6,5 x 15,5 | 24 | 116178 | 2,26€ |
| 12 cl - 5,4 x 13,1 | 6 | 116179 | 2,09€ |

LA VERRERIE

Verre à pied

MERAVIGLIOSI



| Dimension | ♠ | P.U |
|--------------------|------------------|--------------|
| 30 cl - Coupe | 24 116171 | 4,47€ |
| 35 cl - Sauterne | 24 116172 | 3,50€ |
| 45 cl - Chardonnay | 24 116173 | 3,96€ |
| 70 cl - Cabernet | 24 116174 | 4,78€ |

SUPREMO



| Dimension | ♠ | P.U |
|--------------------|-----------------|--------------|
| 45 cl - VAP | 6 116138 | 5,21€ |
| 35 cl - VAP | 6 116139 | 5,29€ |
| 24 cl - Flûte | 6 116140 | 4,64€ |
| 45 cl - Gobelet FB | 6 116141 | 3,57€ |

ZENITH



| Dimension | ♠ | P.U |
|---------------------|------------------|--------------|
| 48 cl - Verre à vin | 24 114835 | 3,27€ |
| 35 cl - Verre à vin | 24 114834 | 3,06€ |
| 25 cl - Verre à vin | 24 114833 | 3,00€ |
| 19 cl - Flûte | 24 114836 | 3,00€ |
| 45 cl (Forme Haute) | 24 115477 | 2,88€ |

DOMAINE



| Dimension | ♠ | P.U |
|---------------------------|------------------|--------------|
| 47 cl - Ø 9 x H 22,4 cm | 12 123953 | 3,51€ |
| 37 cl - Ø 8,3 x H 20,2 cm | 24 123952 | 3,23€ |
| 27 cl - Ø 7,6 x H 18,2 cm | 24 123951 | 3,03€ |



PRINCESA

Verre trempé Arcoroc



| Dimension | ♠ | P.U |
|---------------------------|------------------|--------------|
| 23 cl - Ø 6,7 x H 17,4 cm | 6 101520 | 3,29€ |
| 19 cl - Ø 6,9 x H 16,5 cm | 6 101519 | 3,05€ |
| 15 cl - Ø 5 x H 19,6 cm | 24 116142 | 2,70€ |



VINA JULIETTE

| Dimension | ♠ | P.U |
|-----------------------------------|------------------|--------------|
| 50 cl - Ø 9,2 x H 21,7 cm | 24 124647 | 2,93€ |
| 40 cl - Ø 8,6 x H 20,6 c | 24 100117 | 2,93€ |
| 30 cl - Ø 7,8 x H 18,8 cm | 24 100118 | 2,76€ |
| 23 cl - Ø 6,5 x H 21,7 cm - Flûte | 24 124648 | 2,76€ |



SPEAKEASY SWING

| Dimension | Quantité | P.U. |
|-------------------------------------|----------|----------------------------|
| 30 cl - Ø 9,3 x 22,7 cm - Vin blanc | 24 | 116175 7,16€ |
| 30 cl - Ø 10,7 x 14,8 cm - Coupe | 24 | 116176 7,16€ |



AMELIA

| Dimension | Quantité | P.U. |
|---------------------------|----------|----------------------------|
| 25 cl - Ø 7,9 x H 11,7 cm | 48 | 101159 2,84€ |
| 19 cl - Ø 7,2 x H 10,6 cm | 48 | 101019 2,82€ |



INAO

Verre non trempé

| Dimension | Quantité | P.U. |
|----------------------------|----------|----------------------------|
| 21 cl - Ø 6,5 cm - H 16 cm | 48 | 100105 1,90€ |



SAVOIE

Verre non trempé



| Dimension | Quantité | P.U. |
|---------------------------------------|----------|----------------------------|
| 24,5 cl - Ø 7,4 x 15,2 cm - Eau / Vin | 48 | 116143 2,00€ |
| 19 cl - Ø 6,9 x 14 cm - Eau / Vin | 48 | 116144 1,90€ |
| 14,5 cl - Ø 6,4 x 13,4 cm - Porto | 48 | 116145 1,75€ |
| 17 cl - Ø 6,1 x 17 cm - Flûte | 48 | 116146 2,00€ |



LYONNAIS

| Dimension | Quantité | Gris | Améthyste | Transparent | P.U. |
|----------------------|----------|---------------|---------------|---------------|--------------|
| 23 cl - Verre à pied | 1 | 102992 | 102993 | 102991 | 5,09€ |

LA VERRERIE

Verre à pied



ELEGANCE

| Dimension | ☛ | | P.U |
|-------------------------------------|----|---------------|--------------|
| 24,5 cl - Ø 7,4 x H 16,6 cm | 12 | 101224 | 2,11€ |
| 19 cl - Ø 6,9 x H 15,3 cm | 12 | 101219 | 1,92€ |
| 17 cl - Ø 5,5 x H 17,5 cm | 12 | 101217 | 1,99€ |
| 16 cl - Ø 9,0 x H 12,2 cm - Coupe | 12 | 107145 | 2,47€ |
| 14,5 cl - Ø 6,4 x H 14,2 cm - Porto | 12 | 101214 | 1,94€ |
| 13 cl - Ø 4,7 x H 17,9 cm | 12 | 101213 | 2,06€ |
| 10 cl - Ø 4,7 x H 15,9 cm | 12 | 101210 | 1,94€ |



ADAGIO

| Dimension | ☛ | | P.U |
|---|---|---------------|---------------|
| 22 cl - Ø 8,7 x H 20,6 cm - Verre à vin | 2 | 115456 | 29,86€ |
| 18 cl - Ø 7,6 x H 24,7 cm - Flûte | 2 | 115457 | 34,21€ |

SENSA

Chaque forme de verre correspond exactement à un arôme ou à un style de vin. Les cinq formes de verre couvrent donc tous les vins importants et les vins mousseux.



| Dimension | ☛ | | P.U |
|-----------------------------|---|---------------|--------------|
| 71 cl - Ø 10,5 x H 23 cm | 6 | 107133 | 5,39€ |
| 66 cl - Ø 9,4 x H 24,3 cm | 6 | 107132 | 5,39€ |
| 53,5 cl - Ø 8,8 x H 23,6 cm | 6 | 107134 | 5,39€ |
| 38,8 cl - Ø 7,2 x H 24 cm | 6 | 107135 | 5,39€ |
| 36,3 cl - Ø 7,6 x H 22,2 cm | 6 | 107136 | 5,39€ |

SYMÉTRIE

| Dimension | ☛ | | P.U |
|---------------------------------|----|---------------|--------------|
| 55 cl - Ø 9,2 x 26 cm | 12 | 116127 | 4,60€ |
| 45 cl - Ø 8,7 x 25 cm | 24 | 116128 | 4,21€ |
| 35 cl - Ø 7,8 x 23 cm | 24 | 116129 | 4,21€ |
| 58 cl - Ø 10,6 x 20,9 cm | 24 | 116130 | 4,60€ |
| 21 cl - Ø 11,4 x 18 cm | 24 | 116131 | 5,00€ |
| 21 cl - Ø 6,5 x 24 cm - Flûte | 24 | 116132 | 4,41€ |
| 16 cl - Ø 6,5 x 19,8 cm - Flûte | 24 | 116133 | 3,82€ |



FLORIAN

| Dimension | ☛ | | P.U |
|-----------------------|---|---------------|--------------|
| 30 cl - Gobelet Rocks | 6 | 115467 | 3,48€ |
| 37,5 cl - Chope Dof | 6 | 115466 | 3,87€ |



MARILYN

Forme représentée par une cascade de points lumineux.

| Dimension | ☛ | | P.U |
|---------------------------------------|---|---------------|---------------|
| 26 cl - Ø 9 x H 21 cm - Verre à vin | 2 | 115458 | 35,05€ |
| 21 cl - Ø 8,5 x H 20 cm - Verre à vin | 2 | 115459 | 30,53€ |
| 17 cl - Ø 7,6 x H 24,4 cm - Flûte | 2 | 115460 | 35,05€ |



LA VERRERIE

Verre jaugé



CABERNET JAUGÉ

| Dimension | | P.U |
|---|------------------|--------------|
| 35 cl - Ø 8,1 x H 20,2 cm - Jaugé ellipse 12,5/ 14,5 cl | 24 107167 | 3,94€ |



VINS JEUNES

| Dimension | | P.U |
|---|------------------|--------------|
| 58 cl - Ø 10 x H 22 cm - Jaugé cassure 16 cl | 24 113396 | 3,82€ |
| 47 cl - Ø 9,7 x H 21 cm - Jaugé cassure 13 cl | 24 113395 | 3,50€ |
| 35 cl - Ø 9 x H 20 cm - Jaugé cassure 10 cl | 24 113394 | 3,50€ |



VITICOLE JAUGÉ

| Dimension | | P.U |
|--|------------------|--------------|
| 21,5 cl jaugé spirale bas 12,5 / haut 14,5 cl - Ø 6,5 x H 15,5 cm 48 | 100104 | 3,03€ |
| 21,5 cl jaugé trait 12 cl - Ø 6,5 x H 14,5 cm | 24 107169 | 2,91€ |



VOS VERRES PERSONNALISÉS



VERRE NONIC (56cl)

Nonic, une collection de verres à bière classique, en verre trempé pour augmenter la durée de vie. Parfait pour les bars et la maison.

ETAPE 1 Choix du verre

Cabernet Tulipe
Verre à vin
Verre Nonic
Verre à bière

ETAPE 2

Les caractéristiques

Le décor- Logo- La quantité souhaitée
La validation de l'emplacement du décor
Ajuster ou Centrer- Marquage en couleur
ou noir et blanc

ETAPE 3

Le devis

Validation par un BAT
avant production

CABERNET TULIPE (53cl)

Une transparence absolue, garde son extrême brillance lavage après lavage. Possède une très haute résistance, il résiste incroyablement aux chocs de la vie.



Consultez nous pour personnaliser vos verres

ELEMENTS GOBELET



| Dimension | | Ambre | Brun | Vert olive | Lila | Gris | Bleu gris | P.U |
|---------------------|---|---------------|---------------|---------------|---------------|---------------|---------------|---------------|
| 33,5 cl - H 11,8 cm | 1 | 114961 | 114963 | 114966 | 114965 | 114964 | 114967 | 40,20€ |

DIAMOND

Empilable, teintée masse



| Dimension | | Transparent | Bleu | Violet | P.U |
|---------------------------|---|---------------|---------------|---------------|--------------|
| 30 cl - Ø 8,4 x H 9,25 cm | 6 | 107198 | 114190 | 114191 | 1,80€ |

ROCK BAR LOUNGE



| Dimension | | Pêche | Menthe | Bleu | P.U |
|-----------------|----|---------------|---------------|---------------|--------------|
| 27 cl - Gobelet | 24 | 114183 | 114184 | 114185 | 2,33€ |
| 37 cl - Chope | 24 | 114186 | 114187 | 114188 | |



SALTO

Teintée dans la masse



| Dimension | | | P.U |
|-------------------------|----|---------------|--------------|
| 35 cl - Ø 7,6 x 12,1 cm | 24 | 100910 | 1,99€ |
| 32 cl - Ø 9 x 8,4 cm | 24 | 100911 | 1,99€ |

Gobelet et chope

PRIMARY



| Dimension | ☛ | P.U |
|----------------------------|----|---------------------|
| 44 cl - Ø 8,7 x 11 cm* | 24 | 107979 2,42€ |
| 40 cl - Ø 7,6 x H 12,7 cm* | 24 | 107978 2,44€ |
| 36 cl - Ø 8,1 x 10,2 cm | 24 | 107980 2,14€ |
| 27 cl - Ø 7,3 x 9,3 cm | 24 | 107981 2,24€ |

FH* Forme Haute



ALKEMIST

| Dimension | ☛ | P.U |
|------------------------------|---|----------------------|
| 38 cl - Ø 8,7 x 9,5 - par 6 | 2 | 115485 26,33€ |
| 35 cl - Ø 8,7 x 10,3 - par 6 | 2 | 115486 28,80€ |



VINA JULIETTE

| Dimension | ☛ | P.U |
|--|----|---------------------|
| 40 cl - Ø 8,7 x H 11 cm - (Forme Haute) | 24 | 124649 1,65€ |
| 35 cl - Ø 9,4 x H 8,3 cm - (Forme Basse) | 24 | 124650 1,65€ |



LIMA

| Dimension | ☛ | P.U |
|-------------------------|----|---------------------|
| 45 cl - Ø 7,7 x H 16 cm | 24 | 107201 2,71€ |
| 40 cl - Ø 7,7 x H 13 cm | 24 | 107202 2,38€ |
| 38 cl - Ø 8,8 x H 11 cm | 24 | 112197 2,29€ |
| 35 cl - Ø 9,4 x H 8 cm | 24 | 112196 2,30€ |

VINA



| Dimension | ☛ | P.U |
|---------------------------|----|---------------------|
| 36 cl - Ø 7,6 x H 12,1 cm | 24 | 123647 1,55€ |
| 34 cl - Ø 8,9 x H 8,3 cm | 24 | 123646 1,55€ |



SENSA

| Dimension | ☛ | P.U |
|-------------------------|----|---------------------|
| 50 cl - Ø 8,4 x H 12 cm | 24 | 107137 5,65€ |



ADAGIO

| Dimension | ☛ | P.U |
|------------------------------|---|----------------------|
| 40 cl - Ø 7,8 x 15 - par 6 | 2 | 115487 28,32€ |
| 35 cl - Ø 8,8 x 10,1 - par 6 | 2 | 115488 24,17€ |



FLORIAN

| Dimension | ☛ | P.U |
|--------------------------|---|---------------------|
| 43 cl - Chope Long Drink | 6 | 115465 3,87€ |



ELLIPTIQUE DIVA

| Dimension | ☛ | P.U |
|-----------------|---|---------------------|
| 40 cl - Chope | 6 | 116185 5,89€ |
| 32 cl - Gobelet | 6 | 116184 5,45€ |
| 25 cl - Gobelet | 6 | 116183 5,45€ |

Gobelet et chope

ARCOROC  OGO novaStyl

GLEN



| Dimension | Quantité | Code | P.U |
|-----------------------|----------|---------------|--------------|
| 35,5 cl (Forme Haute) | 24 | 115476 | 2,08€ |
| 33 cl (Forme Basse) | 48 | 115475 | 1,88€ |

SALTO



| Dimension | Quantité | Code | P.U |
|--|----------|---------------|--------------|
| 50 cl - Ø 8,2 x H 14,6 cm, (Forme Haute) | 48 | 103354 | 2,06€ |
| 35 cl - Ø 7,6 x H 12,1 cm, (Forme Haute) | 24 | 100900 | 1,66€ |
| 32 cl - Ø 9 x H 8,4 cm, (Forme Basse) | 24 | 100901 | 1,70€ |
| 6,5 cl - Ø 4,8 x H 6,6 cm, (Forme Haute) | 48 | 103351 | 1,35€ |

ZENITH



| Dimension | Quantité | Code | P.U |
|---------------------|----------|---------------|--------------|
| 45 cl (Forme Haute) | 24 | 115477 | 2,88€ |

NEXT



Verre empilable



| Dimension | Quantité | Code | P.U |
|---------------------------|----------|---------------|--------------|
| 25 cl - Ø 7,3 x H 11,8 cm | 12 | 112993 | 1,25€ |
| 20 cl - Ø 7,1 x H 9,6 cm | 12 | 100833 | 0,91€ |
| 16 cl - Ø 6,6 x H 7,9 cm | 48 | 100834 | 0,76€ |

HABANA



Verre empilable



| Dimension | Quantité | Code | P.U |
|--------------------------|----------|---------------|--------------|
| 22 cl - Ø 7,7 x H 8,2 cm | 12 | 112265 | 1,27€ |
| 16 cl - Ø 7 x H 7,5 cm | 12 | 112264 | 1,00€ |

FORUM



Gobelet empilable

| Dimension | Quantité | Code | P.U |
|--------------------------|----------|---------------|--------------|
| 23 cl - Ø 8,1 x H 7,7 cm | 12 | 112261 | 8,69€ |
| 16 cl - Ø 7,2 x H 6,9 cm | 12 | 101417 | 7,13€ |

BOURBON STREET



| Dimension | Quantité | Code | P.U |
|---------------------|----------|---------------|--------------|
| 32 cl - Forme Basse | 12 | 114839 | 3,58€ |
| 36 cl - Forme Haute | 12 | 114838 | 3,94€ |



Gobelet et chope



LOLA

Verre empilable

Dimension

| Dimension | Quantité | Code | P.U. |
|--------------------------|----------|--------|-------|
| 20 cl - Ø 7,4 x H 7,6 cm | 72 | 111121 | 0,88€ |
| 16 cl - Ø 7 x H 7,1 cm | 72 | 111116 | 0,74€ |



ISTANBUL

Verre mécanique

Dimension

| Dimension | Quantité | Code | P.U. |
|--|----------|--------|-------|
| 25 cl - Ø 7,35 x H 8,8 cm, (Forme Basse) | 24 | 113812 | 0,98€ |
| 18,5 cl - Ø 6,85 x H 8 cm, (Forme Basse) | 12 | 113813 | 0,88€ |



GIGOGNE

Verre mécanique, empilable

Dimension

| Dimension | Quantité | Code | P.U. |
|------------------------|----------|--------|-------|
| 16 cl - Ø 7 x H 6,9 cm | 72 | 101011 | 0,79€ |



LOG

Verre empilable

Dimension

| Dimension | Quantité | Code | P.U. |
|--------------------------|----------|--------|-------|
| 32 cl - Ø 7 x H 12 cm | 48 | 123945 | 1,35€ |
| 27 cl - Ø 7,6 x H 9,3 cm | 48 | 123944 | 1,27€ |
| 22 cl - Ø 7,3 x H 7,9 cm | 72 | 123943 | 1,22€ |
| 16 cl - Ø 6,3 x H 8 cm | 72 | 123942 | 1,22€ |



OXYGÈNE

Gobelet empilable

Dimension

| Dimension | Quantité | Code | P.U. |
|-----------|----------|--------|-------|
| 16 cl | 72 | 111015 | 1,15€ |



CAMPUS

Verre empilable

Dimension

| Dimension | Quantité | Code | P.U. |
|--------------------------|----------|--------|-------|
| 18 cl - Ø 6,5 x H 8,8 cm | 12 | 101018 | 1,24€ |
| 22 cl - Ø 6,4 x H 9,7 cm | 48 | 101020 | 1,24€ |



PICARDIE

Dimension

| Dimension | Quantité | Code | P.U. |
|---------------|----------|--------|-------|
| 16 cl - par 6 | 12 | 115480 | 5,77€ |
| 13 cl - par 6 | 12 | 115479 | 5,42€ |
| 9 cl - par 6 | 24 | 115478 | 4,79€ |

BODÉGA



Dimension

| Dimension | Quantité | Code | P.U. |
|-----------------------------------|----------|--------|--------|
| 51 cl - Ø 7,7 x H 9,7 cm - par 12 | 1 | 123147 | 17,50€ |
| 37 cl - Ø 8,5 x H 8,9 cm - par 12 | 1 | 101038 | 15,31€ |
| 20 cl - Ø 5,7 x H 8 cm - par 12 | 1 | 101015 | 13,99€ |



LA VERRERIE

Verre à cocktail



ALKEMIST

| Dimension | Quantité | P.U. |
|------------------------------------|----------|----------------------|
| 58 cl - Ø 10,8 x H 20,8 cm - par 6 | 2 | 115489 39,81€ |
| 53 cl - Ø 10 x H 22,5 cm - par 6 | 2 | 115490 38,67€ |



HOLIDAY

| Dimension | Quantité | P.U. |
|---------------------------|----------|---------------------|
| 47 cl - Ø 8,5 x H 19,6 cm | 12 | 113881 2,97€ |

MIXOLOGY



| Dimension | Quantité | P.U. |
|---|----------|---------------------|
| 80 cl - Ø 11,9 x H 20,5 cm - Gin Tonic | 12 | 115495 6,40€ |
| 57 cl - Ø 9,1 x H 22,5 cm - Spritz | 24 | 115496 5,56€ |
| 46 cl - Ø 9,7 x H 12,7 cm - Cognac | 12 | 115500 5,63€ |
| 22,5 cl - Ø 9,5 x H 14 cm - Coupe | 24 | 115498 4,31€ |
| 21,5 cl - Ø 10,4 x H 17,2 cm - Martini | 24 | 115499 5,28€ |
| 15 cl - Ø 6,9 x H 14,7 cm - Nick & Nora | 24 | 115497 3,52€ |

SPKSY



| Dimension | Quantité | P.U. |
|---|----------|---------------------|
| 58 cl - Ø 10,3 x H 20,3 cm - Gin Tonic | 12 | 115491 4,43€ |
| 24,5 cl - Ø 9,65 x H 15,23 cm - Calice | 6 | 115494 4,43€ |
| 24,5 cl - Ø 7,9 x H 16 cm - Nick & Nora | 12 | 115493 4,43€ |
| 19,3 cl - Ø 9,9 x H 16,4 cm - Martini | 6 | 115492 4,43€ |



GRANITY

| Dimension | Quantité | P.U. |
|--|----------|---------------------|
| 65 cl - Ø 9,6 x H 17,8 cm, (Forme Haute) | 12 | 113158 2,98€ |
| 46 cl - Ø 8,7 x H 16 cm, (Forme Haute) | 24 | 103356 1,94€ |
| 42 cl - Ø 8,9 x H 13 cm, (Forme Haute) | 24 | 103357 1,74€ |
| 35 cl - Ø 8,5 x H 12,1 cm, (Forme Haute) | 6 | 103358 1,86€ |
| 31 cl - Ø 7,4 x H 14 cm, (Forme Haute) | 6 | 103359 1,86€ |
| 20,4 cl - Ø 6,4 x H 12,7 cm, (Forme Haute) | 24 | 103360 1,44€ |

| Dimension | Quantité | P.U. |
|--|----------|---------------------|
| 35 cl - Ø 9,2 x H 10,7 cm, (Forme Basse) | 24 | 103365 1,62€ |
| 27 cl - Ø 8,5 x H 9,8 cm, (Forme Basse) | 6 | 103364 1,44€ |
| 20 cl - Ø 8 x H 8 cm, (Forme Basse) | 24 | 103363 1,44€ |
| 16 cl - Ø 7,3 x H 7,3 cm, (Forme Basse) | 48 | 103362 1,24€ |
| 4,5 cl - Ø 5 x H 5,7 cm, (Forme Basse) | 48 | 103361 1,12€ |



TIMELESS

| Dimension | Quantité | P.U. |
|------------------------------------|----------|---------------------|
| 55 cl - VAP | 24 | 122802 4,77€ |
| 21 cl - Ø 7,4 x 8,3 cm - Chope FB | 24 | 103386 2,15€ |
| 45 cl - Ø 7,8 x 16,1 cm - Chope FH | 24 | 103383 3,28€ |



MAI TAI

| Dimension | Quantité | P.U. |
|-----------|----------|----------------------|
| 49 cl | 1 | 115501 11,46€ |



PINA COLADA

| Dimension | Quantité | P.U. |
|-----------|----------|----------------------|
| 50,5 cl | 1 | 115502 11,46€ |



LA VERRERIE

Verre à bière

SÉQUENCE

| Dimension | Quantité | Code | P.U |
|-----------------------|----------|--------|-------|
| 37 cl - Ø 8 x H 15 cm | 24 | 123408 | 4,48€ |



CERVOISE

| Dimension | Quantité | Code | P.U |
|---------------------------|----------|--------|-------|
| 32 cl jaugé 25 cl | 6 | 116181 | 4,28€ |
| 50 cl - Ø 8,3 x H 19,2 cm | 24 | 112247 | 3,57€ |
| 38 cl - Ø 7,6 x H 17,8 cm | 24 | 115503 | 3,80€ |
| 32 cl - Ø 7,2 x H 16,8 cm | 24 | 112248 | 3,76€ |



TULIP

| Dimension | Quantité | Code | P.U |
|-------------------------|----------|--------|-------|
| 38,5 cl - Ø 7 x H 19 cm | 24 | 114845 | 2,09€ |



ULTIMATE

| Dimension | Quantité | Code | P.U |
|-----------------------|----------|--------|-------|
| 57 cl - Ø 9 x H 16 cm | 24 | 102416 | 2,07€ |



MOSCOW MULE

Cuivre martelé

| Dimension | Quantité | Code | P.U |
|---------------------|----------|--------|-------|
| 45 cl - 8,5 x 10 cm | 1 | 116180 | 9,06€ |



BIRRATÈQUE

| Dimension | Quantité | Code | P.U |
|-----------|----------|--------|-------|
| 50 cl | 6 | 114478 | 6,60€ |
| 60 cl | 6 | 114476 | 6,60€ |



NONIC



| Dimension | Quantité | Code | P.U |
|---------------------------|----------|--------|-------|
| 58 cl - Ø 9 x H 15,1 cm | 12 | 102422 | 1,81€ |
| 29 cl - Ø 7,4 x H 11,5 cm | 12 | 124623 | 1,37€ |



BRITANNIA

| Dimension | Quantité | Code | P.U |
|---------------------------|----------|--------|-------|
| 56 cl - Ø 9,9 x H 12,4 cm | 24 | 100640 | 3,52€ |
| 28 cl - Ø 8,2 x H 9,6 cm | 36 | 100641 | 2,77€ |



GIRAFE

| Dimension | Quantité | Code | P.U |
|-----------|----------|--------|---------|
| 3 L | 1 | 116182 | 103,67€ |





VEGA

Dimension  P.U.
4 cl - Ø 5 x H 3,8 cm 24 **113400** **1,11€**



REGAL

Dimension  P.U.
9,5 cl - Ø 7,7 x H 6 cm 6 **122808** **3,92€**



BUBBLE

Dimension  P.U.
5 cl - Ø 7,7 cm 6 **103754** **2,38€**



DELICE

Dimension  P.U.
8 cl - Ø 5 x H 6,2 cm - par 6 6 **122806** **3,92€**



SWEET

Dimension  P.U.
5 cl - Ø 6,6 cm 6 **103751** **2,76€**



RIVIERA

Dimension  P.U.
11 cl - Ø 7,4 cm 6 **103756** **2,90€**



ROCK BAR

Verre empilable par 6 

Dimension  P.U.
7 cl - Ø 5,1 x H 6,4 cm 6 **123157** **8,25€**



MEB

Dimension  P.U.
10 cl - Ø 5 x H 7,8 cm - par 6 12 **100425** **2,61€**



ELLIPSE

Dimension  P.U.
9 cl - Ø 6,5 x 4,6 x H 6,5 cm 6 **103755** **1,43€**

LA VERRERIE

Verrine mignardise



KUBE

| Dimension | Q | | P.U |
|----------------------|---|---------------|--------------|
| 10 cl - 4,6 x 4,6 cm | 6 | 103753 | 2,72€ |
| 5 cl - 4,5 x 4,5 cm | 6 | 103752 | 2,18€ |



GALA

| Dimension | Q | | P.U |
|---------------------------------|---|---------------|--------------|
| 6,5 cl - Ø 4,6 x H 6 cm - par 6 | 6 | 122807 | 4,08€ |



ESKALE

| Dimension | Q | | P.U |
|--------------------------|----|---------------|--------------|
| 31 cl - Ø 9 x H 8,7 cm | 24 | 123649 | 2,14€ |
| 18 cl - Ø 7,7 x H 7,8 cm | 24 | 123650 | 1,77€ |
| 9 cl - Ø 6,2 x H 6,4 cm | 24 | 103366 | 1,46€ |



MIX AND MATCH

| Dimension | Q | | P.U |
|--------------------------|----|---------------|--------------|
| 11 cl - Ø 6,9 x H 7,6 cm | 12 | 116194 | 1,81€ |

CRÈME BRULÉE



| Dimension | Q | Noir | Blanc | Terracotta | P.U |
|-----------------------|----|---------------|---------------|---------------|--------------|
| Ø 14 x H 3,5 cm | 10 | 116190 | 116193 | - | 2,84€ |
| Ø 13,5 x H 3,3 cm | 12 | - | - | 116186 | 8,73€ |
| Ø 12 x H 3 cm | 24 | 116189 | - | 116188 | 2,48€ |
| Ø 12 x H 3 cm - par 4 | 12 | - | 116192 | - | 6,63€ |
| Ø 8, cm - par 6 | 6 | 116191 | - | - | 7,83€ |
| Ø 8 x H 2 cm | 4 | - | - | 116187 | 4,59€ |



BOCAUX WECK

| Dimension | Q | | P.U |
|--|---|---------------|---------------|
| 37 cl - Ø 11,3 x H 7,5 cm monté - bocal seul Ø 10,7 x H 8,7 cm | 1 | 124133 | 9,12€ |
| 29 cl - Ø 11,3 x H 5,8 cm monté - bocal seul Ø 10,7 x H 5,1 cm | 1 | 124132 | 9,98€ |
| 16,5 cl - Ø 9,3 x H 5,2 cm monté - bocal seul Ø 8,7 x H 4,4 cm | 1 | 124131 | 13,97€ |
| 14 cl - Ø 7,2 x H 7,2 cm monté - bocal seul Ø 6,6 x H 6,8 cm | 1 | 124130 | 13,75€ |

Coupe à glace & dessert

ANTILLAISE

Dimension  1 **114483** **6,16€**



ROCK BAR

Dimension  6 **124629** **4,60€**





ABEILLE

Dimension  6 **114479** **4,79€**



CIRCEE

Dimension  1 **115512** **5,84€**
27 cl
25 cl  1 **115511** **5,28€**



FORTUNA

Dimension  6 **101329** **7,14€**





TAPAS

Dimension  6 **116195** **5,85€**
30 cl - Ø 12 x H 8 cm
16 cl - Ø 9,5 x H 7 cm  6 **116196** **4,09€**



PALMIER

Dimension  24 **102277** **7,26€**
37 cl - Ø 12 x H 20,1 cm
21 cl - Ø 12,5 x H 10,5 cm  24 **102278** **4,19€**



JAZZED

Dimension  12 **112276** **7,08€**



ROCCO

Dimension  12 **114495** **2,78€**



Cuillère à glace

JAZZED

Dimension  12 **102289** **4,80€**



25 cl - Ø 13,4 x H 9,2 cm - Frozen

Coupe à glace & dessert



SORBET

| Dimension | Quantité | Code | P.U. |
|---------------------------|----------|--------|-------|
| 38 cl - Ø 11,7 x H 9,4 cm | 24 | 102286 | 4,67€ |



MAEVA DIAMANT

| Dimension | Quantité | Code | P.U. |
|-------------------------|----------|--------|-------|
| 20 cl - Ø 10 x H 6,2 cm | 24 | 100119 | 2,65€ |



BANANA SPLIT

| Dimension | Quantité | Code | P.U. |
|---------------|----------|--------|--------|
| 22,9 x 4,8 cm | 1 | 116199 | 20,99€ |



ABEILLE

| Dimension | Quantité | Code | P.U. |
|-----------------------------|----------|--------|-------|
| 50 cl - Ø 14 x H 8,5 cm | 6 | 114492 | 5,48€ |
| 22,5 cl - Ø 10,5 x H 6,5 cm | 6 | 114491 | 4,00€ |



BUBBLE

| Dimension | Quantité | Code | P.U. |
|-----------------------|----------|--------|-------|
| 13 cl - Ø 12 x H 9 cm | 1 | 114487 | 2,78€ |
| 13 cl - Ø 12 x H 9 cm | 1 | 114488 | 3,51€ |



ONDINE

| Dimension | Quantité | Code | P.U. |
|---------------------------|----------|--------|-------|
| 23,5 cl - Ø 11 x H 5,2 cm | 72 | 100087 | 1,31€ |



SAMBA

| Dimension | Quantité | Code | P.U. |
|---------------------|----------|--------|-------|
| 12 cm - Coupe apéro | 8 | 115513 | 7,54€ |



MAEVA DOTS

| Dimension | Quantité | Code | P.U. |
|-------------------------|----------|--------|-------|
| 20 cl - Ø 10 x H 6,2 cm | 24 | 100121 | 2,64€ |
| 35 cl - Ø 12 x H 7,4 cm | 24 | 124652 | 2,91€ |



TANGO

| Dimension | Quantité | Code | P.U. |
|-----------|----------|--------|-------|
| 12 cm | 6 | 115514 | 7,41€ |



SODA DRAKKAR

| Dimension | Quantité | Code | P.U. |
|-----------------------------|----------|--------|-------|
| 20 cm - Cuillère à cocktail | 240 | 115515 | 1,38€ |



PICHETS & CARAFES



PICHET

| Dimension | Quantité | Code | P.U |
|---------------------|----------|--------|-------|
| 130 cl jaugé 100 cl | 6 | 100244 | 3,13€ |
| 66 cl jaugé 50 cl | 24 | 100245 | 2,29€ |
| 25 cl jaugé 25 cl | 24 | 100246 | 1,56€ |



BROC

| Dimension | Quantité | Code | P.U |
|-----------------------------------|----------|--------|-------|
| 130 cl - Ø12,5 x H 13,9 x 21,7 cm | 6 | 101000 | 4,24€ |
| 100 cl - Broc arc | 6 | 101006 | 3,87€ |
| 50 cl - Broc arc | 12 | 101005 | 2,89€ |



MISURE

| Dimension | Quantité | Code | P.U |
|-----------------------------|----------|--------|-------|
| 100 cl - Ø 10,8 x H 26,2 cm | 6 | 115516 | 5,15€ |
| 50 cl - Ø 8,4 x H 23,5 cm | 12 | 115517 | 3,29€ |
| 25 cl - Ø 6,8 x H 19 cm | 12 | 115518 | 2,48€ |



YPSILLON

| Dimension | Quantité | Code | P.U |
|-----------------------------|----------|--------|-------|
| 100 cl - Ø 10,4 x H 25,5 cm | 6 | 101600 | 8,32€ |
| 50 cl - Ø 8,4 x H 20,4 cm | 6 | 101550 | 5,05€ |
| 25 cl - Ø 6,8 x H 16,5 cm | 12 | 101525 | 3,76€ |



FLUID

| Dimension | Quantité | Code | P.U |
|---------------------------|----------|--------|-------|
| 100 cl - Ø 10,7 x H 26 cm | 6 | 124216 | 7,84€ |
| 75 cl - Ø 10,7 x H 21 cm | 6 | 123937 | 6,08€ |
| 50 cl - Ø 9,1 x H 19,3 cm | 6 | 124218 | 4,78€ |
| Bouchon seul | | | |
| Dimension | Quantité | Code | P.U |
| Ø 7 x H 3,9 cm | 24 | 116200 | 1,12€ |



OFFICINA

| Dimension | Quantité | Code | P.U |
|--------------------------|----------|--------|-------|
| 120 cl - Ø 9,5 x H 30 cm | 6 | 124625 | 6,13€ |



ORIENTE ACQUA

| Dimension | Quantité | Code | P.U |
|---------------------------|----------|--------|-------|
| 100 cl - Ø 8,5 x H 3,5 cm | 6 | 101699 | 7,11€ |

PICHETS & CARAFES



OPTIMA

| Dimension | 📦 | P.U |
|---|----|----------------------|
| 100 cl - Ø 8,8 x H 31,8 cm - Carafe à vin | 6 | 124651 7,16€ |
| 50 cl - Ø 7,1 x H 26,2 cm - Carafe à vin | 6 | 123540 5,06€ |
| 25 cl - Ø 6 x H 19,6 cm - Carafe à vin | 12 | 123539 3,67€ |
| 75 cl - Ø 8 x H 26 cm - À eau | 6 | 123542 4,41€ |
| 100 cl - H 21,5 cm - Flasque | 6 | 101108 10,02€ |
| Ø 5,9 x H 4,3 cm - Bouchon | 48 | 124626 3,78€ |



VILLAGE

Carafe jaugée

| Dimension | 📦 | P.U |
|----------------------|----|---------------------|
| 70 cl jaugée 50 cl | 6 | 114338 3,33€ |
| 126 cl jaugée 100 cl | 6 | 114339 5,25€ |
| 36 cl jaugée 25 cl | 12 | 114337 2,86€ |



YPSILLON ROND

| Dimension | 📦 | P.U |
|-----------|----|---------------------|
| 100 cl | 6 | 116205 9,54€ |
| 50 cl | 6 | 116202 6,76€ |
| 25 cl | 12 | 116203 4,65€ |



GIARA

| Dimension | 📦 | P.U |
|-----------|---|---------------------|
| 1 L | 6 | 114340 2,68€ |



LYONNAIS

| Dimension | 📦 | P.U |
|-------------------------|---|---------------------|
| 46 cl - Ø 7 x H 29 cm | 6 | 101246 7,58€ |
| 25 cl - Ø 6,3 x H 22 cm | 6 | 101225 6,85€ |



CARAFON

| Dimension | 📦 | P.U |
|-----------------------------|----|---------------------|
| 25 cl - Ø 7,8 x H 13,2 cm | 12 | 101007 1,88€ |
| 50 cl - Ø 9,8 x H 16,4 cm | 12 | 101008 2,27€ |
| 100 cl - Ø 11,9 x H 20,3 cm | 6 | 101010 3,45€ |



VINA

| Dimension | 📦 | P.U |
|-----------------------------|---|----------------------|
| 150 cl - Ø 15,6 x H 24,3 cm | 6 | 116204 30,62€ |



RÉVERIE ANSE

| Dimension | 📦 | P.U |
|-------------------------|---|----------------------|
| 150 cl - Ø 23 x H 23 cm | 4 | 116205 13,54€ |

LES ACCESSOIRES

Corbeilles et compléments

PANIÈRE PAMPA



Panière lavable – 100% polypropylène effet paille tressée

Dimension

Ø 15 x H 12 cm - Ronde



12

Paille

116206

Ecrû

116207

Chocolat

116208

Gris

116209

P.U

19,04€



LES ACCESSOIRES

Corbeilles et compléments

PANIÈRE CÉILLET



Panière lavable – 100% polypropylène effet paille tressée

Dimension

12 x 15 cm



12

Beige / Terracotta

116210

Beige / Acier

116211

Beige / Saugé

116212

Beige / Moutarde

116213

P.U

16,21€



LES ACCESSOIRES

Corbeilles et compléments

PANIÈRE RONDE Panière 100% PVC



| Dimension | | Beige | Moutarde | Noir | P.U |
|-----------|----|--------|----------|--------|--------|
| Ø 15 cm | 12 | 114995 | 114993 | 114991 | 16,21€ |
| Ø 10 cm | 12 | 114994 | 114992 | 114990 | 14,33€ |

PANIÈRE RONDE



| Dimension | | Beige/Carreau noir | Beige/Carreau rouge | Gris/Acier | P.U |
|-----------|----|--------------------|---------------------|------------|--------|
| Ø 15 cm | 12 | 102078 | 102077 | 102075 | 16,21€ |

PANIÈRE CARRÉE Panière 100% PVC



| Dimension | | Noir/Gris | Acier/Moutarde | Blanc/Beige | P.U |
|------------|----|-----------|----------------|-------------|--------|
| 15 x 15 cm | 12 | 115003 | 115001 | 114999 | 20,36€ |
| 12 x 12 cm | 12 | 115002 | 115000 | 114998 | 16,21€ |

PANIÈRE BANDANA 100% PVC



| Dimension | | Blanc/Ardoise | Blanc/Ciel | Blanc/Curcuma | P.U |
|-------------|----|---------------|------------|---------------|--------|
| 11 x H 6 cm | 12 | 115006 | 115004 | 115008 | 20,13€ |
| 10 x H 8 cm | 12 | 115007 | 115005 | 115009 | 16,21€ |



PANIÈRE EMPILABLES Panière lavable - 100% PVC



| Dimension | | Beige / Gris | P.U |
|--------------------------------|----|--------------|--------|
| Ø 12 x 9 cm - Coupelle cottage | 12 | 116214 | 12,21€ |
| Ø 10 x 14 cm - Cornet cottage | 12 | 116215 | |

LES ACCESSOIRES

Corbeilles et compléments

PANIÈRE RONDE Panière à pain 2 faces



| Dimension | | | | | | | P.U |
|-----------|----|---------------|---------------|---------------|---------------|---------------|---------------|
| Ø 15 cm | 12 | 115545 | 115544 | 115543 | 115542 | 115541 | 16,21€ |



| Dimension | | | | | | P.U |
|-----------|----|---------------|---------------|---------------|---------------|---------------|
| Ø 15 cm | 12 | 115550 | 115549 | 115546 | 115548 | 16,21€ |



LES ACCESSOIRES

Corbeilles et compléments



Inox

| Dimension | Quantité | Code | P.U |
|-----------------|----------|--------|-------|
| 31 cm - ovale | 1 | 109072 | 8,90€ |
| 26,5 cm - ovale | 1 | 109071 | 7,04€ |



Inox

| Dimension | Quantité | Code | P.U |
|-----------|----------|--------|-------|
| 20 cm | 1 | 115565 | 6,38€ |



Acier inox martelé

| Dimension | Quantité | Code | P.U |
|------------------|----------|--------|-------|
| Ø 20 cm - H 5 cm | 1 | 115561 | 8,53€ |



Inox - Made in France

| Dimension | Quantité | Gris | Beige | Rouge | P.U |
|-----------|----------|--------|--------|--------|-------|
| Ø 30 cm | 1 | 114511 | 114512 | 114513 | 9,06€ |
| Ø 25 cm | 1 | 114508 | 114509 | 114510 | 7,35€ |



En polypropylène

| Dimension | Quantité | Noir | Taupe | P.U |
|------------------------|----------|--------|--------|-------|
| 15,5 x 12,5 x H 8,5 cm | 6 | 116216 | 116217 | 5,75€ |



| Dimension | Quantité | P.U |
|----------------------------|----------|--------------|
| 24 x 14,5 x H 8 cm - Ovale | 1 | 124030 6,16€ |



| Dimension | Quantité | P.U |
|------------------------------|----------|---------------|
| Ø 34 x 9,5 cm - Tige 4 mm | 1 | 102584 14,84€ |
| Ø 27 x 13,8 cm - Tige 4 mm | 1 | 102583 16,08€ |
| Ø 23,4 x 25,4 cm - Tige 4 mm | 1 | 102582 15,47€ |



Kraft - Lavable

| Dimension | Quantité | P.U |
|--------------------|----------|---------------|
| Ø 20 cm - ronde | 1 | 115563 8,53€ |
| Ø 17 cm - ronde | 1 | 115562 7,02€ |
| 25 x 19 cm - ovale | 1 | 115564 10,44€ |

LES ACCESSOIRES

Sel, poivre, épices et condiments

RUMBA

Le mécanisme poivre est en acier taillé. Le mécanisme sel est en acier inoxydable traité anti corrosion. Les mécanismes en acier sont garantis à vie. Le mécanisme céramique permet l'utilisation de nombreuses épices. La finition laquée brillante et les teintes vitaminées apportent une touche colorée et égayent cuisine et table. Garantis à vie.



| Dimension | | Naturel | Foncé | P.U | Rouge | Noir | P.U |
|--------------------|---|---------|--------|--------|--------|--------|--------|
| H 21 cm - À sel | 1 | 115583 | 115584 | 20,59€ | 115593 | 115594 | 23,92€ |
| H 21 cm - À poivre | 1 | 115581 | 115582 | 20,59€ | 115588 | 115589 | 23,92€ |
| H 21 cm - À épices | 1 | 115585 | 115586 | 20,59€ | 115598 | 115599 | 23,92€ |

JAVA

La gamme JAVA est le moulin traditionnel par excellence, le bois se décline en 4 coloris naturels. Disponible en moulin à poivre, moulin à sel de 14 à 40 cm et moulin à épices de 14 à 25 cm. La taille 70 cm existe uniquement pour le moulin à poivre.



| Dimension | | Clair | Foncé | P.U | Blanc mat | Noir mat | P.U |
|--------------------|---|--------|--------|--------|-----------|----------|--------|
| H 14 cm - À sel | 1 | 124379 | 124380 | 17,12€ | 124381 | 124382 | 18,67€ |
| H 14 cm - À poivre | 1 | 124375 | 124376 | 17,12€ | 124377 | 124378 | 18,67€ |
| H 14 cm - À épices | 1 | 124383 | 124384 | 17,12€ | 124385 | 124386 | 18,67€ |



| Dimension | | Clair | P.U |
|--------------------|---|--------|---------|
| H 70 cm - À poivre | 1 | 124391 | 136,78€ |
| H 40 cm - À poivre | 1 | 124390 | 45,77€ |
| H 30 cm - À poivre | 1 | 124389 | 32,09€ |

| Dimension | | Clair | P.U |
|--------------------|---|--------|--------|
| H 25 cm - À épices | 1 | 124388 | 25,63€ |
| H 21 cm - À épices | 1 | 124387 | 21,20€ |



Finition laquée

| Dimension | | Blanc | Rouge | Noir | P.U |
|--------------------|---|--------|--------|--------|--------|
| H 14 cm - À sel | 1 | 115571 | 115572 | 115573 | 17,12€ |
| H 14 cm - À poivre | 1 | 115566 | 115567 | 115568 | 18,67€ |
| H 14 cm - À épices | 1 | 115576 | 115577 | 115578 | 18,67€ |

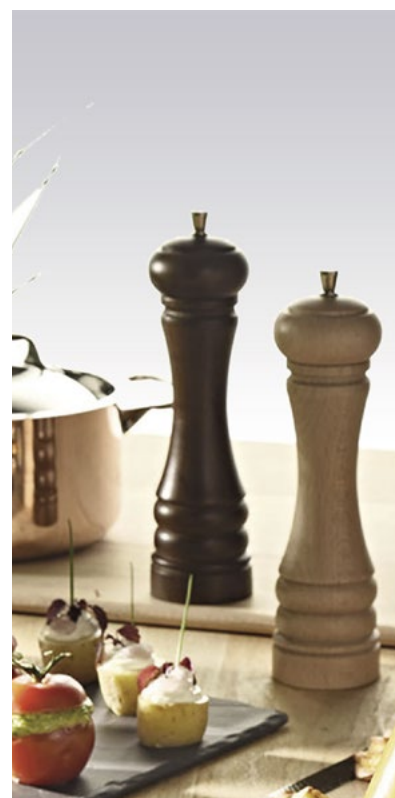

LES ACCESSOIRES

Sel, poivre, épices et condiments



MÉNAGÈRE

| Dimension | Quantité | Code | P.U |
|--------------------------------|----------|--------|--------|
| Huilier ou vinaigrier - par 12 | 1 | 114008 | 20,31€ |
| Salière ou poivrière - par 12 | 1 | 114009 | 10,96€ |



| Dimension | Quantité | Code | P.U |
|---------------------------------|----------|--------|-------|
| Sel, poivre et moutarde - par 3 | 1 | 123805 | 5,60€ |



| Dimension | Quantité | Code | P.U |
|---------------------------|----------|--------|-------|
| Huile et vinaigre - par 2 | 1 | 109154 | 5,98€ |
| Sel et poivre - par 2 | 1 | 109152 | 3,59€ |



| Dimension | Quantité | Code | P.U |
|--------------------------------------|----------|--------|-------|
| Sel, poivre, huile, vinaigre - par 4 | 1 | 114007 | 7,17€ |



| Dimension | Quantité | Code | P.U |
|------------------------------|----------|--------|-------|
| Sel et poivre - avec support | 1 | 116220 | 9,42€ |

MOULIN À ÉPICES



| Dimension | Quantité | Code | P.U |
|-------------------|----------|--------|--------|
| H 11 cm - Hip Hop | 1 | 116219 | 13,50€ |



| Dimension | Quantité | Code | P.U |
|-----------------|----------|--------|--------|
| H 14 cm - Tango | 1 | 116218 | 17,23€ |



Mécanisme céramique. Moulin livré vide.

| Dimension | Quantité | Code | P.U |
|-----------------|----------|--------|--------|
| H 18 cm - Mambo | 1 | 115602 | 19,25€ |



DISTRIBUTEUR DE MIEL

| Dimension | Quantité | Code | P.U |
|-----------|----------|--------|--------|
| H 12,5 cm | 1 | 123248 | 10,36€ |



SAUPOUDREUSE

| Dimension | Quantité | Code | P.U |
|---------------------|----------|--------|-------|
| H 12,5 cm - À sucre | 1 | 123244 | 9,08€ |



| Dimension | Quantité | Code | P.U |
|-----------------------|----------|--------|-------|
| H 12,5 cm - À fromage | 1 | 123247 | 8,05€ |



SALIÈRE POIVRIÈRE

| Dimension | Quantité | Code | P.U |
|-----------------------|----------|--------|-------|
| H 12,5 cm - Salière | 1 | 123246 | 8,02€ |
| H 12,5 cm - Poivrière | 1 | 123245 | 8,14€ |

LES ACCESSOIRES

Plats de service



PLAT À GRATIN

| Dimension | Quantité | Rectangulaire | P.U |
|------------|----------|---------------|---------------|
| 37 x 25 cm | 1 | 109037 | 15,07€ |
| 30 x 21 cm | 1 | 109230 | 13,02€ |



PLAT À GRATIN

| Dimension | Quantité | Ovale | P.U |
|----------------|----------|---------------|---------------|
| 38 x 23,5 cm | 1 | 109038 | 14,24€ |
| 30,5 x 18,5 cm | 1 | 109030 | 10,48€ |
| 25 x 15,5 cm | 1 | 109024 | 8,58€ |



PLAT OVALE

| Dimension | Quantité | P.U |
|--------------|----------|---------------------|
| 46 x 30 cm | 1 | 109206 9,78€ |
| 41 x 27 cm | 1 | 109205 8,63€ |
| 38 x 25 cm | 1 | 109204 7,98€ |
| 34 x 22 cm | 1 | 109203 6,38€ |
| 27 x 17,5 cm | 1 | 109202 4,81€ |
| 22 x 14 cm | 1 | 109213 3,82€ |



SOUPIÈRE

| Dimension | Quantité | P.U |
|-----------|----------|----------------------|
| Ø 24 cm | 1 | 109124 16,27€ |
| Ø 22 cm | 1 | 109122 13,79€ |



LÉGUMIER

| Dimension | Quantité | P.U |
|-----------|----------|----------------------|
| Ø 22 cm | 1 | 109222 10,48€ |
| Ø 20 cm | 1 | 109220 9,32€ |
| Ø 16 cm | 1 | 109217 6,31€ |
| Ø 12 cm | 1 | 109215 3,34€ |



PLAT ROND

| Dimension | Quantité | P.U |
|-----------|----------|---------------------|
| Ø 30 cm | 1 | 116221 8,82€ |



PLAT POISSON

| Dimension | Quantité | P.U |
|-----------|----------|----------------------|
| 60 cm | 1 | 109201 11,13€ |



PLAT À ESCARGOT

| Dimension | Quantité | P.U |
|----------------------|----------|----------------------|
| Ø 21 cm - 12 places | 24 | 109176 13,91€ |
| Ø 15,5 cm - 6 places | 24 | 109175 9,08€ |



PINCE À ESCARGOT

| Dimension | Quantité | P.U |
|-----------|----------|---------------------|
| 16 cm | 1 | 123216 3,51€ |



FOURCHETTE À ESCARGOT

| Dimension | Quantité | P.U |
|-----------|----------|---------------------|
| Lot de 12 | 1 | 116222 3,53€ |

LES ACCESSOIRES

Fruits de mer

PLATEAU DE FRUITS DE MER INOX



| Dimension | Quantité | Code | P.U. |
|-----------|----------|--------|--------|
| Ø 50 cm | 1 | 112639 | 23,03€ |
| Ø 42 cm | 1 | 112641 | 14,66€ |
| Ø 28 cm | 1 | 112644 | 6,57€ |

SUPPORT PLATEAU INOX



| Dimension | Quantité | Code | P.U. |
|-----------------------|----------|--------|-------|
| Ø 24,5 x 19 x H 20 cm | 1 | 102519 | 9,96€ |



PINCE À HOMARDS



| Dimension | Quantité | Code | P.U. |
|----------------|----------|--------|-------|
| 16 cm - Chromé | 1 | 115658 | 6,86€ |

PINCE À HOMARDS



| Dimension | Quantité | Code | P.U. |
|-----------------------------|----------|--------|--------|
| 14,4 cm - Fonte d'aluminium | 1 | 115659 | 12,85€ |

ACCESSOIRES



| Dimension | Quantité | Code | P.U. |
|---|----------|--------|-------|
| Curette à crabes et homards - Lot de 12 | 12 | 115661 | 5,10€ |



| Dimension | Quantité | Code | P.U. |
|----------------------|----------|--------|--------|
| Pique bigorneaux | 150 | 109083 | 2,48€ |
| 1000 piques jetables | 1 | 123227 | 23,42€ |



| Dimension | Quantité | Code | P.U. |
|------------------|----------|--------|--------|
| Casse noix inox | 12 | 114975 | 13,09€ |
| Couteau à beurre | 1 | 123452 | 1,57€ |



| Dimension | Quantité | Code | P.U. |
|----------------------|----------|--------|-------|
| Fourchette à huîtres | 1 | 116228 | 2,82€ |



LES ACCESSOIRES

Fruits de mer

COCOTTE À MOULES



| Dimension | Quantité | Bleu | Vert | Menthe | Orange | Rouge | Blanc | P.U |
|-----------|----------|--------|--------|--------|--------|--------|--------|--------|
| Ø 18 cm | 6 | 114981 | 114982 | 114978 | 114980 | 114979 | - | 14,16€ |
| Ø 12 cm | 1 | - | - | 114986 | - | - | 114984 | 7,74€ |



| Dimension | Quantité | Noir | P.U |
|-----------|----------|--------|-------|
| Ø 18 cm | 6 | 114977 | 9,61€ |
| Ø 16 cm | 1 | 114976 | 8,11€ |

RINCE-DOIGTS



| Dimension | Quantité | P.U |
|------------------------|----------|----------------|
| 6,8 x 10 cm - par 1000 | 1.2 | 102127 109,81€ |



| Dimension | Quantité | P.U |
|------------------------|----------|----------------|
| 14,5 x 4 cm - par 1000 | 1.28 | 102128 122,46€ |



LES ACCESSOIRES

Plateaux de service

PLATEAU POLYESTER



Garantie 10 ans contre la casse.
Bossages de séchage.
Garantie lave-vaisselle.



| Dimension | | Ananas | Blanc cassé | Granit émeraude | Granit ambre | Granit gris | Granit bleu | Granit rose | Kiwi | Lavande | P.U |
|------------|----|--------|-------------|-----------------|--------------|-------------|-------------|-------------|--------|---------|--------|
| 46 x 36 cm | 20 | 204096 | 264630 | 204093 | 246362 | 204094 | 264632 | 264633 | 204095 | 204097 | 22,13€ |



PLATEAU ACER PP

| Dimension | | Blanc | Noir | Rouge | P.U |
|----------------|----|--------|--------|--------|--------|
| 60 x 40 cm | 20 | 201009 | 114974 | 201012 | 16,16€ |
| 45,7 x 35,7 cm | 40 | - | 115604 | 115603 | 9,58€ |



PLATEAU POLYESTER

| Dimension | | Gris moucheté | P.U | Gris clair | P.U |
|-----------------------|----|---------------|-------|------------|-------|
| 46 x 36 cm | 12 | 201898 | 9,29€ | 201895 | 6,54€ |
| GN 1/1 53 x 32,5 cm | 12 | 201899 | 9,94€ | 201896 | 6,96€ |
| GN 1/2 32,5 x 26,5 cm | 12 | 201900 | 7,76€ | 201897 | 5,75€ |

LES ACCESSOIRES

Plateaux de service

PLATEAU POLYESTER-STR PROFIL R/V



| Dimension | | ● Chêne clair | ● Chêne gris | ● Erable foncé | ○ Marbre Blanc | ● Rouille | P.U |
|----------------|----|---------------|---------------|----------------|----------------|---------------|---------------|
| 53 x 32,5 cm | 20 | 115618 | 115617 | 115619 | 115615 | 115616 | 31,50€ |
| 46 x 36 cm | 20 | 115608 | 115607 | 115609 | 115605 | 115606 | 29,78€ |
| 32,5 x 26,5 cm | 20 | 115613 | 115612 | 115614 | 115610 | 115611 | 20,85€ |



PLATEAU POLYESTER PROFIL 2



| Dimension | | ○ Marbre blanc | ● Rouille | ● Chêne gris | ● Chêne clair | ● Erable foncé | P.U |
|------------|----|----------------|---------------|---------------|---------------|----------------|---------------|
| 46 x 36 cm | 20 | 116223 | 116224 | 116225 | 116226 | 116227 | 31,26€ |





PLATEAU BASIK



Polyester. Garantie 3 ans contre la casse.
Bossages de séchage. Garantie lave-vaisselle



| Dimension | | ● Beige fumé | ● Gris fumé | P.U |
|----------------|----|---------------|---------------|---------------|
| 53 x 32,5 cm | 20 | 201423 | 201424 | 10,30€ |
| 46 x 36 cm | 20 | 299916 | 299917 | 10,21€ |
| 32,5 x 26,5 cm | 20 | 201427 | 201428 | 6,66€ |



PLATEAU POLYESTER

Plateau polyester pour un trafic intensif. Garantie 5 ans.

| Dimension | | ● Anthracite | ● Granité gris | P.U |
|--------------------|----|---------------|----------------|---------------|
| GN1/1 53 x 32,5 cm | 12 | 200790 | 200791 | 13,93€ |
| 46 x 36 cm | 12 | - | 200787 | 12,76€ |
| 32,5 x 26,5 cm | 12 | - | 200789 | 8,27€ |



FAST-FOOD

| Dimension | | ● Noir | ● Bleu marine | ● Marron | ● Bleu ciel | ● Rouge | ● Vert | P.U |
|----------------|----|---------------|---------------|---------------|---------------|---------------|---------------|--------------|
| 45,7 x 35,5 cm | 24 | 299516 | 201913 | 299515 | 299513 | 299514 | - | 4,66€ |
| 41 x 30 cm | 24 | - | 201919 | 201917 | 201918 | 201916 | 201915 | 3,57€ |
| 34,5 x 26,5 cm | 1 | - | 201912 | 299509 | 299507 | 299511 | 299512 | 3,10€ |

LES ACCESSOIRES

Plateaux de service



PLATEAU VTC

| Dimension | ● | ● | P.U |
|-----------|----|---------------|---------------|
| | ● | ● | |
| | | Chêne brun | |
| GN1/2 | 12 | 115649 | 10,19€ |



PLATEAU VTC

| Dimension | ● | ● | ● | P.U |
|------------|----|---------------|---------------|---------------|
| | ● | ● | ● | |
| | | Chêne gris | Chêne foncé | |
| 36 x 46 cm | 12 | 115656 | - | 15,97€ |
| 33 x 43 cm | 12 | 115651 | - | 14,59€ |
| 32 x 53 cm | 12 | - | 115657 | 16,93€ |

PLATEAU SUPREX SLIM 2



Stratifié mélaminé, surface grain mat. Garantie lave-vaisselle. Double mélamine recto/verso.

| Dimension | ● | ● | ● | ● | ● | ● | ● | ● | ● | ● | ● | ● | P.U |
|------------|----|---------------|---------------|---------------|---------------|---------------|---------------|---------------|---------------|---------------|---------------|---------------|---------------|
| | ● | ● | ● | ● | ● | ● | ● | ● | ● | ● | ● | ● | |
| | | Rouille | Ardoise | Blanc | Chêne clair | Chêne gris | Marbre blanc | Marbre beige | Marbre gris | Okoumé | Roc brun | Cèdre foncé | |
| 37 x 28 cm | 20 | 115632 | 115633 | 115638 | 115635 | 115629 | 115628 | 115631 | 115630 | 115637 | 115634 | - | 14,91€ |
| 28 x 20 cm | 20 | 115643 | 115645 | 115648 | 115646 | 115640 | 115639 | 115642 | 115641 | 115647 | 115644 | - | 10,74€ |
| 28 x 28cm | 20 | - | - | - | - | - | - | - | - | - | - | 115636 | |



L'ACCUEIL

En salle

SOMMAIRE | INDEX



ACCESSOIRES

Porte-parapluies



| Dimension | | Noir | P.U |
|---------------------------|---|--------|--------|
| 25 x 25 x H 52 cm - 25 Lt | 1 | 102996 | 21,49€ |

Canne à journaux



| Dimension | | Bois clair | P.U |
|---------------------|---|------------|--------|
| 75 cm, avec crochet | 6 | 109347 | 14,48€ |



| Seau addition | | En zinc | P.U |
|---------------|---|---------|-------|
| 6,5 x 6,5 cm | 1 | 114238 | 2,52€ |

| Plateau addition à pince | | Inox | P.U |
|--------------------------|---|--------|-------|
| 18 x 13 cm | 1 | 109107 | 3,11€ |

| Bloc commande | | | P.U |
|---------------------------------|---|--------|--------|
| Tripli, 7,5 x 15 cm_ par 6 x 10 | 1 | 278153 | 85,12€ |
| Dupli, 7,5 x 15 cm_ par 6 x 10 | 1 | 278152 | 51,90€ |

PORTE-AFFICHES

Ces porte-affiches de tables transparentes en acrylique sont disponibles avec affichage deux faces ou trois faces. Ils sont disponibles en deux tailles différentes. Facile à nettoyer.

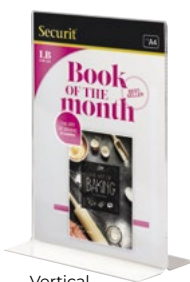

en L

Vertical

3 faces

| Dimension | | en L | P.U | Vertical | P.U | 3 faces | P.U |
|-----------|---|--------|-------|----------|-------|---------|-------|
| A5 | 1 | 124090 | 4,49€ | 124091 | 5,57€ | 124089 | 7,43€ |
| A4 | 1 | 124092 | 5,80€ | 124093 | 6,58€ | - | - |

CHEVALETS



| Dimension | | | P.U |
|--------------------|---|--------|--------|
| 8 x 4 cm - Neutre | 1 | 123736 | 13,53€ |
| 8 x 4 cm - Réservé | 1 | 123737 | 13,53€ |



| Dimension | | Bois naturel | P.U |
|-----------------------------|---|--------------|--------|
| Ø 5,5 x 5,5 cm - Réservé | 1 | 102544 | 57,88€ |
| Ø 5,5 x 5,5 cm - N° 11 à 20 | 1 | 102546 | 52,09€ |
| Ø 5,5 x 5,5 cm - N° 1 à 10 | 1 | 116229 | 57,88€ |

Porte étiquette



| Dimension | | Translucide | P.U |
|-----------|---|-------------|--------|
| 8 x 6 cm | 1 | 102995 | 24,45€ |

SONNETTE DE COMPTOIR



| Dimension | | | P.U |
|-----------|---|--------|-------|
| Ø 8,5 cm | 1 | 115016 | 3,23€ |

CENDRIERS



| Dimension | | Verre | P.U |
|------------------------------|----|--------|-------|
| Ø 8,5 x H 3,5 cm - empilable | 24 | 102535 | 1,72€ |

| Dimension | | Inox | P.U |
|--------------------------|---|--------|--------|
| Pour extérieur - à poser | 1 | 114985 | 34,76€ |

L'ACCUEIL

En salle



ECRITOU

| Dimension | Teinté chêne | P.U |
|-------------|-----------------|---------------|
| 65 x 95 cm | 1 300324 | 67,47€ |
| 60 x 110 cm | 1 300325 | 81,37€ |
| 45 x 65 cm | 1 312041 | 50,50€ |

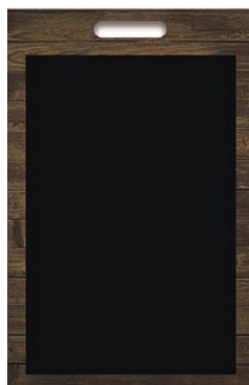

PRAHA

Ardoise murale et portable

| Dimension | P.U |
|------------|-------------------------------|
| 50 x 70 cm | 1 114543 30,19€ |



ETIQUETTES PANCARTES

| Dimension | P.U |
|-------------------------------|-------------------------------|
| 30 x 40 cm - PS 1 mm. | |
| Livré avec attaches adhésives | 1 102551 10,92€ |



GABY

Ardoise murale avec cordelette pour suspension

| Dimension | P.U |
|------------|-------------------------------|
| 50 x 70 cm | 1 103004 23,06€ |



PORTLAND

Ardoise avec cintre pour suspension

| Dimension | P.U |
|------------|-------------------------------|
| 50 x 70 cm | 1 103005 20,77€ |

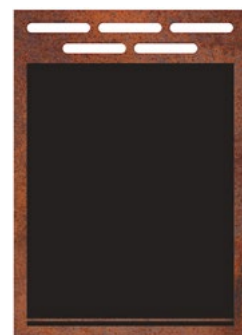

CARGO

Ardoise portable

| Dimension | P.U |
|------------|-------------------------------|
| 50 x 70 cm | 1 103003 33,07€ |



| Dimension | P.U |
|---|------------------------------|
| 16 x 24 cm - Panneau horaires. Fil nylon pour suspension et planche de jours adhésifs | 1 102552 8,39€ |



STILO

Ardoise PVC expansé 3 mm + Support bois

| Dimension | P.U |
|------------|-------------------------------|
| 15 x 22 cm | 1 300350 48,38€ |
| 21 x 30 cm | 1 300143 57,51€ |



ALTO

Plexiglass avec support bois

| Dimension | P.U |
|---------------------------|-------------------------------|
| 21 x 30 cm - plexi 1,5 mm | 1 102998 60,52€ |
| 15 x 22 cm - plexi 1,5 mm | 1 102997 52,24€ |



FEUTRE-CRAIE

Waterproof

| Dimension | Lot de 4 | P.U |
|------------------|-----------------|---------------|
| 7-15 mm Couleurs | 1 124059 | 20,45€ |
| 7-15 mm Blanc | 1 124060 | 21,33€ |
| 2-6 mm Couleurs | 1 124058 | 9,23€ |
| Dimension | Lot de 2 | P.U |
| 2-6 mm Couleurs | 1 124057 | 4,25€ |



FEUTRE-CRAIE

| Dimension | Lot de 4 | P.U |
|------------------|-----------------|---------------|
| 7-15 mm Couleurs | 1 124072 | 17,90€ |
| 7-15 mm Blanc | 1 124073 | 17,93€ |
| 2-6 mm Couleurs | 1 124070 | 9,23€ |
| 2-6 mm Blanc | 1 124071 | |



Feutre pointe biseautée

| Lot de 2 | Argent | Or | Blanc | Noir | P.U |
|--|-----------------|---------------|---------------|--------------|---------------|
| 1 116236 | 116237 | 116238 | 116248 | 8,48€ | |
| Dimension | | | | | P.U |
| Lot de 8 (jaune, rouge, rose, orange, bleu, vert, violet, blanc) | 1 116240 | | | | 35,02€ |



Pour les ardoises et les surfaces sérigraphiées en ardoisine.

| Dimension | P.U |
|-----------------|--------------|
| 1 301343 | 5,48€ |

Effaçable à l'alcool

| Dimension | P.U |
|-------------|-------------------------------|
| Boite de 10 | 1 116234 27,50€ |



| Feutre pointe biseautée | Blanc | P.U |
|-------------------------|-----------------|--------------|
| Lot de 2 | 1 116239 | 8,48€ |

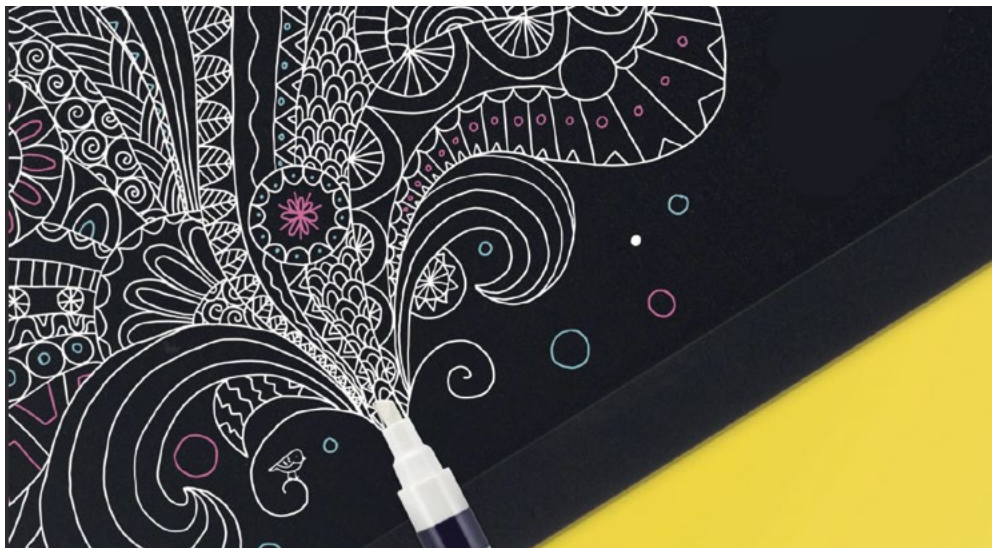

PLANCHES MENU

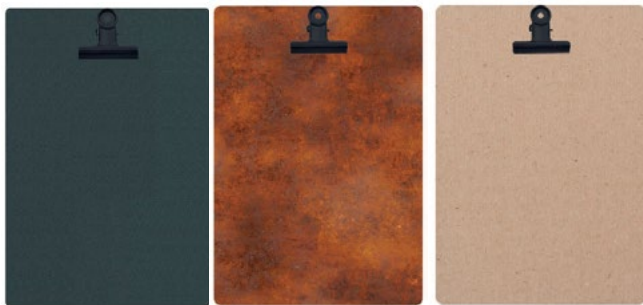

Système à pince métal. Planche en matériau composite alu/PVC 3 mm.

| Dimension | | Gris | Rustique | Bois | P.U |
|------------|---|--------|----------|--------|--------|
| 23 x 33 cm | 1 | 116244 | 116245 | 116246 | 13,31€ |



LIVERPOOL

Décor cadre bois peint fond blanc + feutre noir. Matériau composite alu/PVC 3 mm. Chaînette de suspension. Affichage vertical ou horizontal.

| Dimension | | P.U |
|------------|---|---------------|
| 40 x 60 cm | 1 | 116247 24,15€ |



PORTE-MENU CORK

| Dimension | | Liège | P.U |
|---------------------|---|--------|---------|
| 35,2 x 27 x 14,6 cm | 1 | 102529 | 159,80€ |



PORTE-MENU CORK

Pour 10 cartes menu A4

| Dimension | | Liège | P.U |
|------------------------|---|--------|--------|
| A4 - 4 pages | 1 | 123507 | 14,23€ |
| Carte des vins 4 pages | 1 | 123508 | |

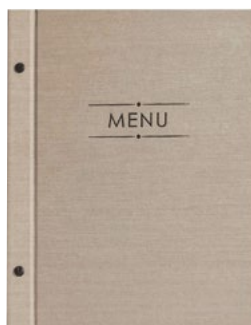

CARTE MENU PAUL

Fabriqu  en cuir Telflex 3 Intercalaires

| Dimension | | P.U |
|----------------|---|---------------|
| 25,5 x 32 (A4) | 1 | 202072 16,78€ |



INTERCALAIRE

PVC cristal

| Dimension | | P.U |
|------------|---|--------------|
| 21 x 30 cm | 1 | 103007 1,74€ |

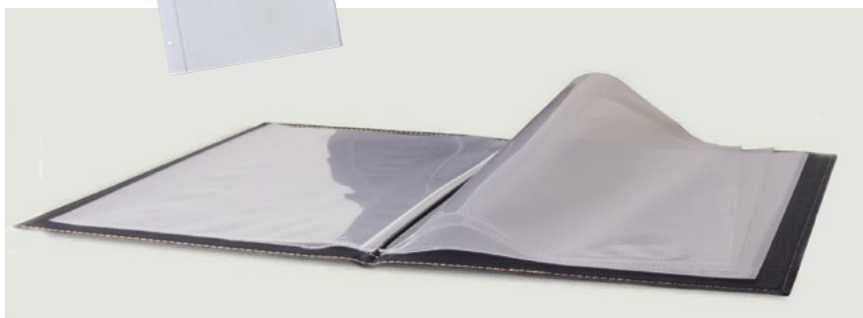



TRENDY RANGE

| Dimension | | | P.U |
|----------------------|---|---------------|--------------|
| 23,4 x 12,8 x 0,5 cm | 1 | 116230 | |
| 18,4 x 10,4 x 2 cm | 1 | 102526 | 7,99€ |
| 18,3 x 12,5 x 4 cm | 1 | 116231 | |



CARTE MENU TRENDY RANGE

Dimension

34 x 24,6 x 0,4 cm - A4

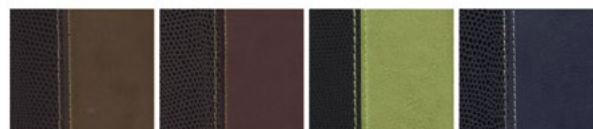

| | Noir | Marron | Bordeaux | Vert | Bleu | P.U |
|---|---------------|---------------|---------------|---------------|---------------|---------------|
| 1 | 124064 | 202042 | 124063 | 202039 | 202041 | 12,00€ |

PORTE MENU TRENDY RANGE

Pour 20 cartes menu A4

Dimension

35,2 x 27,9 x 19,7 cm



| | Noir | Marron | Bordeaux | Vert | Bleu | P.U |
|---|---------------|---------------|---------------|---------------|---------------|----------------|
| 1 | 123502 | 123506 | 123503 | 123504 | 123505 | 209,36€ |

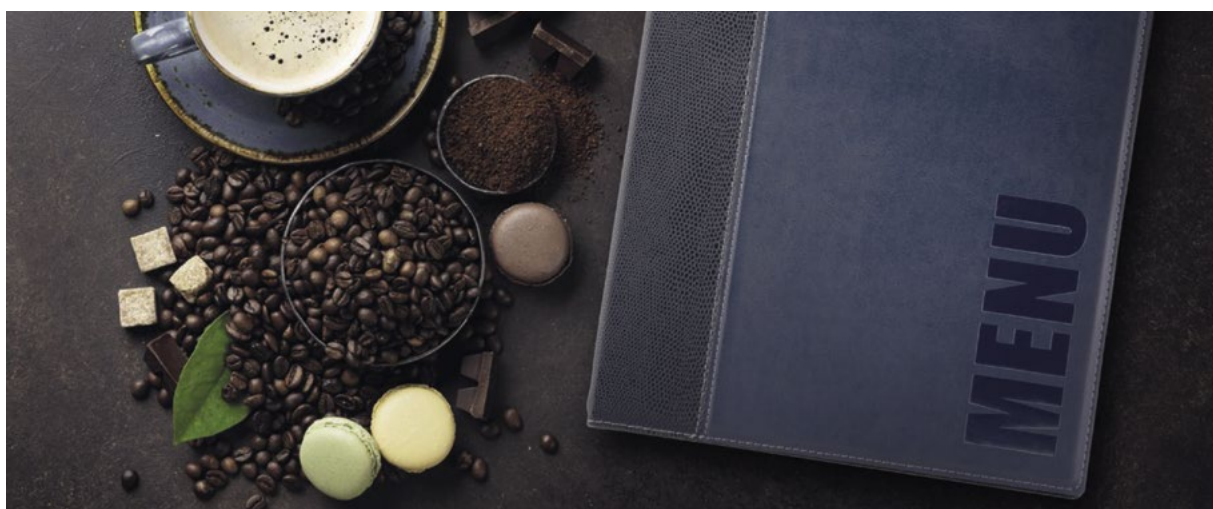



PANNEAUX

Avec un fil nylon pour suspension

| Dimension | | Orange | Vert | Violet | P.U |
|------------|---|--------|--------|--------|--------|
| 30 x 40 cm | 1 | 300532 | 116241 | 116242 | 16,28€ |
| 40 x 60 cm | 1 | 300533 | 364697 | 116243 | |



| Dimension | | P.U |
|------------------------------|---|--------------|
| 29,5 x 18 cm - PS blanc 1 mm | 1 | 362907 8,30€ |

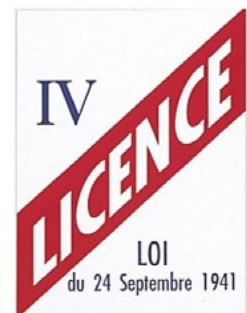

| Licence IV | Dimension | | P.U |
|---------------------------------|-----------|--------|--------|
| 15 x 20 cm - PS blanc 1 mm | 1 | 116232 | 11,59€ |
| 17 x 24 cm - Adhésif + chiffres | 1 | 116233 | 9,80€ |



Fil nylon pour suspension et 1 feutre effaçable à sec

| Dimension | | P.U |
|------------|---|---------------|
| 30 x 40 cm | 1 | 116235 20,24€ |



Fil nylon

| Dimension | | P.U |
|------------------------------|---|--------------|
| 18 x 29,5 cm - PS blanc 1 mm | 1 | 362908 8,30€ |



| Dimension | | P.U |
|------------|---|---------------|
| 45 x 60 cm | 1 | 301396 64,50€ |

L'ACCUEIL

Extérieur



PANNEAUX

PVC noir 3 mm - 2 trous pour suspension

| Dimension | | Fait maison | Toque seul | Chef vous propose | P.U |
|------------|---|---------------|---------------|-------------------|---------------|
| 50 x 70 cm | 1 | 102550 | 102548 | 102549 | 21,06€ |



STAINLESS STEEL

| Dimension | | | P.U |
|----------------------|---|---------------|----------------|
| 78 x 50,7 x 5 cm | 1 | 123518 | 664,30€ |
| 69,5 x 52,3 x 6,5 cm | 1 | 123517 | 474,50€ |
| 121 x 15 x 15 cm | 1 | 116249 | 123,37€ |
| 43,4 x 38,3 x 57 cm | 1 | 124137 | 123,37€ |
| 127 x 40 x 40 cm | 1 | 116250 | 93,95€ |



| Dimension | | | P.U |
|-----------------|---|---------------|---------------|
| 5,5 x 12 x 9 cm | 1 | 116251 | 27,52€ |



| Dimension | | | P.U |
|---------------------|---|---------------|---------------|
| 16,5 x 7,5 x 1,3 cm | 1 | 123516 | 93,95€ |



MÉTALIX

2 pages recto/verso. Acier recouvert d'une peinture epoxy gris anthracite.

| Dimension | | | P.U |
|--------------------|---|---------------|----------------|
| 50 x 41,5 x 7,5 cm | 1 | 103008 | 105,81€ |



L'ACCUEIL

Extérieur



CARGO

2 panneaux en matériaux composite ALU / PVC - épaisseur 3 mm.

| Dimension | | P.U |
|------------|---|-----------------------|
| 59 x 95 cm | 1 | 103002 125,58€ |



PONDICHERY

2 panneaux en matériaux composite ALU / PVC - épaisseur 3 mm.

| Dimension | | P.U |
|---------------------------|---|-----------------------|
| 59 x 95 cm - décor rosace | 1 | 103011 112,21€ |



CASTEL

2 panneaux en matériaux composite ALU / PVC - épaisseur 6 mm.

| Dimension | | P.U |
|---------------------------|---|-----------------------|
| 59 x 95 cm - décor rosace | 1 | 103001 113,84€ |



PRAHA

| Dimension | | P.U |
|------------|---|-----------------------|
| 59 x 95 cm | 1 | 116252 112,21€ |



CARNAVAL

Encadrement bois lauré vernis.

| Dimension | | P.U |
|---------------------|---|-----------------------|
| 67,5 x 11,5 x 80 cm | 1 | 362106 340,91€ |



STOP TROTTOIR PERSONNALISABLE

| Dimension | | P.U |
|-------------|---|-----------------------|
| 60 x 150 cm | 1 | 102547 244,87€ |

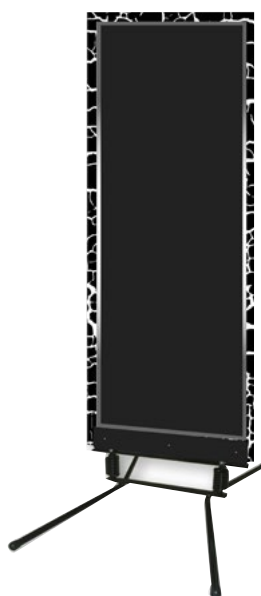

NÉO

Matériau composite ALU / PVC - épaisseur 6 mm.

| Dimension | | P.U |
|-------------|---|-----------------------|
| 60 x 150 cm | 1 | 103013 291,33€ |



LE BAR

Accessoires



| Tire-bouchon mural | | P.U. |
|--------------------|---|-----------------------|
| ● Bleu | 1 | 115017 |
| ● Rouge | 1 | 115018 259,26€ |
| ● Gris | 1 | 115019 |



Acier inoxydable

| Tire-bouchon pliant Pulltap's | | P.U. |
|-------------------------------|---|---------------------|
| 12 cm | 1 | 103018 8,85€ |



| Dimension | | P.U. |
|-----------|---|---------------------|
| À levier | 1 | 109000 5,15€ |



| Pompe à vide d'air pour le vin | | P.U. |
|--------------------------------|---|----------------------|
| Avec 2 bouchons hermétiques | 1 | 116253 22,99€ |



| Lot de 4 bouchons hermétiques | | P.U. |
|-------------------------------|---|----------------------|
| Dimension | 1 | 116254 11,42€ |
| Pour pompe à vide d'air | 1 | 116254 11,42€ |



| Bouchon à champagne | | P.U. |
|---------------------|--------|--------------|
| 12 | 112221 | 4,79€ |



| Bouchon à champagne à pompe | | P.U. |
|-----------------------------|---|----------------------|
| Dimension | 1 | 116255 18,90€ |
| Avec bec verseur | 1 | 116255 18,90€ |



| Doseur Bec Métal | | P.U. |
|------------------|----|---------------------|
| 4 cl | 25 | 114518 4,00€ |
| 2 cl | 25 | 114517 3,90€ |



| Doseur poussoir ABS | | P.U. |
|---------------------|---|----------------------|
| 2 cl - 8,5 x 15 cm | 1 | 103016 36,51€ |



| Doseur - verseur | | P.U. |
|------------------|----|---------------------|
| L 11 cm | 12 | 113259 4,67€ |



| Bouchon doseur verseur | | P.U. |
|------------------------|---|---------------------|
| 2 cl | 1 | 103015 7,62€ |



| Pompe doseuse à sirop | | P.U. |
|----------------------------|---|---------------------|
| 4 ml - L 36 cm - Clipsable | 1 | 103017 7,10€ |



Broyeur manuel à glace

17 x 13 x 24,5



4

100049

P.U
22,06€

Shaker martello



1

114520

P.U
10,87€

75cl - Ø 9 x H 24 cm



Cocktail Master

Dimension

12 x 12 x 27 cm



6

100029

P.U
56,56€



Passoire à cocktail

15 cm



1

116260

P.U
7,52€

Pince à glaçons



1

100052

P.U
1,90€

L 18 cm



Inox

Dimension

4 cl / 2 cl



6

100057

P.U
5,51€



Cuillère pilon

L 26,5 cm



1

122735

P.U
3,12€



Mortier et pilon en granit

Ø 16 cm

Ø 14 cm

Ø 12 cm



1

116258

P.U
22,69€

1

116257

21,82€

1

116256

18,71€

LE BAR

Accessoires



Rack à verres suspendu

| Dimension | Quantité | Code | P.U |
|--------------------------|----------|--------|--------|
| 45 x 31,6 cm - 20 verres | 5 | 109339 | 20,39€ |



Tapis bar antidérapant

| Dimension | Quantité | Code | P.U |
|----------------|----------|--------|--------|
| 45,7 x 30,5 cm | 24 | 113412 | 12,77€ |



Bac en caoutchouc avec couvercle

| Dimension | Quantité | Code | P.U |
|--------------|----------|--------|-------|
| 23,5 x 11 cm | 1 | 116261 | 7,38€ |



Bac en latex avec couvercle et support

| Dimension | Quantité | Code | P.U |
|--------------|----------|--------|--------|
| 33,5 x 18 cm | 1 | 116262 | 15,75€ |



Plexiglass

Louche à punch

| Dimension | Quantité | Code | P.U |
|-----------|----------|--------|-------|
| L 35 cm | 1 | 114237 | 5,14€ |



Louche de service monobloc

| Dimension | Quantité | Code | P.U |
|-----------|----------|--------|-------|
| | 1 | 102038 | 5,51€ |



ECO-Pailles en verre droites

Dimension

| Dimension | Quantité | Code | P.U |
|---------------------------|----------|--------|--------|
| 21 cm - Ø 7-8 mm - Par 50 | 1 | 116259 | 22,24€ |



Ramasse-miettes

| Dimension | Quantité | Code | P.U |
|-----------|----------|--------|--------|
| 15,2 cm | 1 | 103022 | 18,66€ |



Ramasse miettes

À rouleau

| Dimension | Quantité | Code | P.U |
|-----------|----------|--------|--------|
| | 1 | 109246 | 36,12€ |

LE BAR

Accessoires



| Dimension | | Chromé | Bois | P.U |
|-------------------|---|---------------|---------------|---------------|
| 47 x 47 x 82 cm | 1 | 263000 | - | 84,98€ |
| 43 x 37,5 x 81 cm | 1 | - | 114047 | 77,59€ |



PLATEAU
ANTIDÉRAPANT

| Dimension | | Prune | P.U | Marron | Noir | Bordeaux | P.U |
|-----------|----|---------------|---------------|---------------|---------------|---------------|---------------|
| Ø 45 cm | 6 | 264645 | 24,37€ | 201892 | 201891 | - | 24,64€ |
| Ø 40,5 cm | 12 | - | - | 201890 | 201889 | - | 20,65€ |
| 45 cm | 1 | - | - | - | - | 103021 | 23,65€ |
| 40,5 cm | 6 | - | - | - | - | 103020 | 18,59€ |



| Dimension | | Noir | Marron | P.U |
|--------------------|----|---------------|---------------|---------------|
| 68 x 56 cm - ovale | 6 | - | 201886 | 49,30€ |
| Ø 35,5 cm | 12 | 201887 | 201888 | 16,41€ |



LE BAR

Accessoires



Seau à glace avec anneaux

Ø 14 x H 13 cm 1 123734 4,45€



Seau à glace

Ø 11,5 cm - H 11 cm 1 114987 20,01€



Seau avec anse

Ø 14 x H 12 cm 1 114003 4,59€



Seau à glace isotherme

Ø 12 x H 13,50 cm 1 113266 14,92€



Sac à bouteille

Transparent 10 114050 5,10€



Seau à champagne avec anneaux

Ø 20 x H 21 cm 1 109051 13,08€



Rafraîchisseur de bouteilles

Ø 12 x H 18 cm 1 100715 13,35€



Corps en ABS, double paroi injectée, isolation par mousse de polyuréthane. Couvercle à vis, grille de décantation. Isotherme 8 H.

Conservateur à glaçons

Ø 25, H 21 cm - 400 cl 1 100051 28,60€



Seau à champagne  Acrylique **P.U**
47 x 29 x 23 cm 1 **114051** **20,26€**



Seau à champagne  Noir **P.U**
35 x 27, H 25,5 cm 1 **113153** **35,55€**



Rafraîchisseur  Inox **P.U**
61 x 43 x 28 cm 1 **114052** **54,31€**



Seau à champagne  Inox 18/10 **P.U**
Ø 34,50 cm 1 **100713** **28,07€**



Support de table pour seau à champagne  Inox **P.U**
Ø 18 cm 1 **100711** **22,65€**



Support seau à champagne  Inox **P.U**
H 72 cm 1 **123258** **22,22€**



Support seau avec pied  Inox **P.U**
H 67,5 cm 1 **109052** **43,38€**

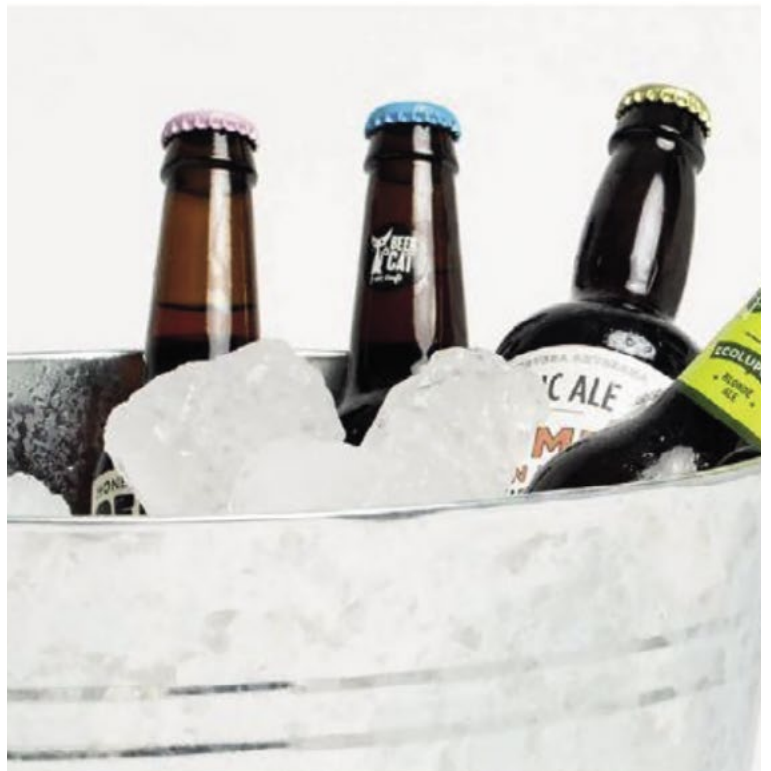

LE BUFFET

Accessoires



| Pince buffet | Quantité | Rouge | Bleu | Jaune | Vert | Noir | P.U |
|--------------|----------|--------|--------|--------|--------|--------|-------|
| 30 cm | 1 | 112573 | 112575 | 112572 | 112574 | 112571 | 4,79€ |
| 24 cm | 1 | 112568 | 112570 | 112567 | 112569 | 112566 | 4,44€ |



| Pince buffet | Quantité | Acier inoxydable | P.U |
|--------------|----------|------------------|-------|
| 40 cm | 1 | 103031 | 4,47€ |
| 30 cm | 1 | 103030 | 3,47€ |
| 24,5 cm | 1 | 102565 | 2,88€ |



| Pince de service dentelée | Quantité | Noir | P.U |
|---------------------------|----------|--------|-------|
| 30,5 cm | 12 | 109131 | 6,89€ |
| 23 cm | 12 | 109123 | 4,58€ |



| Pince multi-usages | Quantité | Inox | P.U |
|--------------------|----------|--------|--------|
| 25 cm | 1 | 112563 | 13,38€ |



| Cuillère de service | Quantité | Transparent | P.U |
|---------------------|----------|-------------|--------|
| 33 cm - Pleine | 12 | 109433 | 10,20€ |
| 33 cm - Ajourée | 12 | 109434 | |



| Pince à spaghettis | Quantité | Inox | P.U |
|--------------------|----------|--------|-------|
| 20 cm | 1 | 109164 | 3,63€ |



| Pince de service | Quantité | Inox | P.U |
|------------------|----------|--------|-------|
| 21 cm | 1 | 112562 | 3,58€ |

VALMY



| | Quantité | Inox | P.U |
|-----------------------|----------|--------|-------|
| Fourchette de service | 1 | 102026 | 1,51€ |
| Louche de service | 1 | 102005 | 2,06€ |
| Cuillère de service | 1 | 102025 | 1,51€ |
| Pelle à tarte | 1 | 102006 | |



| | Quantité | Acier inox et manche polypropylène noir | P.U |
|--------------------------|----------|---|-------|
| 34 cm - Cuillère ajourée | 1 | 103023 | 8,76€ |
| 34 cm - Cuillère pleine | 1 | 103024 | 8,76€ |
| 34 cm - 10 cl - Louche | 1 | 103025 | 9,66€ |



| Pince à charcuterie | Quantité | P.U |
|---------------------|----------|--------|
| 21 cm | 1 | 123806 |



| | Quantité | Polyamide nylon | Noir | P.U |
|----------------------------|----------|-----------------|------|-------|
| 30 cm - Louche | 1 | 112767 | | 1,72€ |
| 29,5 cm - Cuillère à sauce | 1 | 112559 | | 1,72€ |



| Pince utilitaire | Quantité | P.U |
|------------------|----------|--------|
| 30 cm | 1 | 103026 |
| 24 cm | 1 | 103027 |

LE BUFFET

Accessoires

Distributeur de sauces d'assaisonnements légers, avec vanne de fermeture. Ensemble du circuit de pompage fermé pour une meilleure conservation du produit. Réduit le niveau de pertes, en distribuant uniquement la quantité souhaitée par pompage. Pompe à sauce verticale : plus grande facilité pour les usagers et évite les déversements accidentels. En polypropylène.



Vendu avec support
Dimension ⊞ **P.U**
38 x 22,5 x H 19,5 cm 1 **124333** **74,89€**



Vendu avec support
Dimension ⊞ **P.U**
38 x 22,5 x H 19,5 cm 1 **124334** **85,57€**



Dimension ⊞ **P.U**
GN2/3 - H 19,5 cm 1 **102521** **113,46€**



Dimension ⊞ **P.U**
GN1/6 x H 19,5 cm 4 **102522** **14,15€**



Dimension ⊞ **P.U**
GN2/3 - H 19,5 cm 1 **102520** **101,77€**

Dimension ⊞ **P.U**
GN1/9 x H 19,5 cm 3 **102523** **13,46€**

Dimension ⊞ **P.U**
30 ml 6 **102524** **12,01€**



LE BUFFET

Accessoires



Bain marie - LUXE SOPA

| Dimension | | P.U |
|----------------------------|---|-----------------------|
| Ø 45 x H 38 cm - 11 Litres | 1 | 102566 457,59€ |



Chafing dish GN1/1

| | | P.U |
|--|---|----------------------|
| | 1 | 116263 82,08€ |

Un chafer élégant à la fois polyvalent et discret pour la meilleure présentation des plats. Le modèle muni d'un couvercle en verre permet de voir le contenu sans ouvrir le chafer - tout en préservant la qualité de aliments. Couvercle amovible équipé d'un déflecteur et d'une charnière bloquante qui permet de maintenir le couvercle fermé, à 45° ou à 90°. Support renforcé avec des pieds de table en caoutchouc afin d'offrir une durée de vie plus longue et un meilleur maintien des chafers. Le couvercle antigouttes et les bacs empêchent la condensation des aliments et de la table. Disponibles avec bac à aliments en inox ultra-brillant ou en porcelaine.



Rond à couvercle en verre

| Dimension | | Inox |
|----------------|---|---------------|
| 39,4 x 39,4 cm | 1 | 114293 |
| 39,2 x 41,2 cm | 1 | - |



Carré à couvercle en verre

| | | Bac gastro inox | P.U |
|--|--|-----------------|----------------|
| | | - | 644,02€ |
| | | 114294 | 847,21€ |



Les température de chauffe maximum 105°C

| Dimension | | P.U |
|-----------|---|----------------------|
| 4 kg | 1 | 109099 39,17€ |



Avec verrouillage par baïonnette

| Brûleur pour chafing dish | | Inox | P.U |
|---------------------------|---|---------------|--------------|
| Ø 9 x 17 x H 6 cm | 1 | 116264 | 9,38€ |



Boite gel de chauffe éthanol

| Contenance | | P.U |
|------------|---|---------------------|
| 225 gr | 1 | 103042 1,96€ |



Bidon de chauffe éthanol

| Contenance | | P.U |
|------------|---|----------------------|
| 225 gr | 1 | 103043 28,57€ |

LE BUFFET

Accessoires



Chariot buffet Noir P.U
Cubic c2. pour 4 bacs GN1/1 1 123464 972,43€



Buffet noir perforé P.U
57 x 37 x 31 cm - Cadre en bois 1 123466 168,42€



Marmite de remise en température rétro 10,4 L P.U

- Métal 1 103039
- Rouge 1 103040 613,97€
- Noir 1 103041



Plaque chauffante Métal P.U
65 x 43 cm - H 6,5 cm 1 103037 214,38€

LE BUFFET

Accessoires petit-déjeuner



Intérieur en acier inoxydable.

| Pichet isotherme | Métal | P.U. |
|------------------|-----------------|---------------|
| 200 cl | 1 103036 | 67,31€ |
| 150 cl | 1 103035 | 52,85€ |
| 90 cl | 1 103034 | 42,12€ |
| 60 cl | 1 103033 | 37,22€ |
| 30 cl | 1 103032 | 33,64€ |



Livré avec étiquettes.

| Pichet isotherme | P.U. |
|-----------------------|---|
| Triple paroi - 200 cl | 1 112749 32,95€ |
| Triple paroi - 120 cl | 1 112748 26,99€ |
| Triple paroi - 60 cl | 1 112747 18,86€ |
| | Blanc Bi colore P.U. |
| 120 cl | 6 102943 102944 18,36€ |



Livrée avec son couvercle en acier inoxydable et polypropylène. Corps en SAN.

| Flûtes hermétique à céréales | Transparent | P.U. |
|------------------------------|-----------------|---------------|
| 120 cl - Ø10xH28 cm | 1 114061 | 38,51€ |



| Pichet de service à pompe | P.U. |
|---------------------------|-------------------------------|
| 3 litres | 2 105004 45,05€ |



| Distributeur à céréales | Transparent | P.U. |
|-------------------------|-----------------|----------------|
| 450 cl - Ø17x22xH53 cm | 1 114059 | 116,14€ |



| Verseuse à pompe | P.U. |
|------------------|-------------------------------|
| 5 litres | 1 116276 47,92€ |



| Distributeur à jus | Acier inox | P.U. |
|--------------------|-----------------|----------------|
| | 1 116275 | 180,55€ |



| Couvercle Gastronorm 1/1 | Transparent | P.U. |
|---|-----------------|---------------|
| Pour conteneurs et bacs Gastronorm 1/1 - 53 x 32,5 cm | 1 116274 | 26,61€ |



Livrée avec son couvercle en acier inoxydable et polypropylène. Corps en SAN.

| Cuiseur à œufs GN 1/3 | P.U. |
|-----------------------|--------------------------------|
| 21,5 x 43 x H 25,5 cm | 1 200732 325,25€ |



| Pichet de service isotherme | P.U. |
|-----------------------------|-------------------------------|
| 2 litres | 3 105002 21,11€ |
| 1,5 litres | 3 113171 20,46€ |
| 1,2 litres | 3 105001 19,30€ |

| Bouchon à gâchette | P.U. |
|-------------------------------|------------------------------|
| Pour pichets 2L, 1,5L et 1,2L | 1 123260 4,55€ |

LE BUFFET

Accessoires

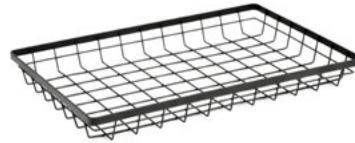

| Présentoir incliné | | P.U | |
|--------------------|---|---------------|---------------|
| À 1 niveau | 1 | 116266 | 24,24€ |

| Panier en métal rectangulaire | | P.U | |
|-------------------------------|---|---------------|---------------|
| 45 x 30 cm | 1 | 116268 | 12,37€ |
| 30 x 22 cm | 1 | 116269 | 10,21€ |



Boîte rectangulaire

| Dimension | | Bois | P.U |
|-----------------|---|---------------|---------------|
| 45 x 30 x 10 cm | 1 | 116271 | 25,29€ |
| 45 x 30 x 5 cm | 1 | 116270 | 19,60€ |

| Dimension | | Bois | P.U |
|-----------------|---|---------------|---------------|
| 30 x 22 x 10 cm | 1 | 116273 | 20,69€ |
| 30 x 22 x 5 cm | 1 | 116272 | 18,56€ |



| Présentoir plat | | P.U | |
|-----------------|---|---------------|---------------|
| À 3 niveau | 1 | 116267 | 37,87€ |
| À 1 niveau | 1 | 116265 | 21,53€ |



| Plat à tarte sur pied | | P.U | |
|-----------------------|---|---------------|---------------|
| Ø 33 x H 9 cm | 4 | 103046 | 15,02€ |



| Plat à tarte | | P.U | |
|--------------|---|---------------|---------------|
| Ø 32 cm | 1 | 103044 | 10,59€ |
| Plat à cake | | P.U | |
| 36 x 15 cm | 2 | 103045 | 10,01€ |

LE BUFFET

Accessoires



| Dimension | ● | Noir | P.U |
|----------------|---|---------------|---------------|
| 28 x 21 x 6 cm | 1 | 103048 | 18,55€ |
| 28 x 21 x 2 cm | 1 | 103047 | 13,08€ |



| Dimension | ● | P.U |
|-----------------------------|---|----------------------|
| GN 1/4 - 26,5 x 16,2 x 8 cm | 1 | 103050 15,14€ |
| GN 1/4 - 26,5 x 16,2 x 2 cm | 1 | 103049 10,22€ |
| GN 1/5 - 26,5 x 20 x 4 cm | 1 | 103051 14,07€ |
| GN 1/5 - 26,5 x 20 x 8 cm | 1 | 103052 21,50€ |

PLAT DE PRÉSENTATION

Plat de présentation pour vitrine en matière plexi durable, grande résistance aux chocs. Sans bisphénol A, lavable au lave-vaisselle, température d'utilisation de -20 à 80°C.



| Dimension | ● | Noir | P.U | ○ | Blanc | P.U |
|----------------------------|---|---------------|---------------|---|---------------|---------------|
| 60 x 40 x 2 cm | 1 | 202433 | 50,71€ | | 115054 | 49,83€ |
| GN1/1 - 53 x 32,5 x 2 cm | 1 | 202434 | 40,52€ | | 115055 | 39,67€ |
| GN1/3 - 32,5 x 17,6 x 2 cm | 1 | 202435 | 12,92€ | | 115056 | 12,82€ |
| GN3/4 - 26,5 x 48,7 x 8 cm | 1 | 202436 | 36,19€ | | 115057 | 35,62€ |
| GN1/2 - 26,5 x 32,5 x 8 cm | 1 | 202438 | 27,46€ | | 115058 | 23,24€ |
| GN1/2 - 26,5 x 32,5 x 5 cm | 1 | 202437 | 23,64€ | | 115059 | 26,96€ |



| Saladier Lodge | ● | Blanc | P.U |
|---------------------------|---|---------------|--------------|
| 90 cl - Ø 23 x H 7-9,5 cm | 6 | 101400 | 6,67€ |
| 20 cl - Ø 14 x H 4-6 cm | 6 | 101407 | 2,93€ |



Saladier rectangulaire

| Dimension | ● | Noir | P.U | ○ | Blanc | P.U |
|-----------------------------|---|---------------|---------------|---|---------------|---------------|
| 150 cl - 27 x 14,5 x 8,5 cm | 1 | 202439 | 16,81€ | | 115060 | 16,61€ |



Bol rond

| | ● | Blanc | Noir | P.U |
|------------------------|---|---------------|---------------|--------------|
| 180 cl - Ø 25 x 8,5 cm | 1 | 102575 | 102578 | 8,75€ |
| 125 cl - Ø 21 x 8 cm | 1 | 102574 | 102577 | 7,82€ |
| 70 cl - Ø 17 x 7 cm | 1 | 102573 | 102576 | 6,48€ |

LE BUFFET

Accessoires



| | | |
|--------------|-----------------|----------------|
| Serre jambon | Blanc | P.U |
| 62 x 26 cm | 1 202406 | 196,45€ |



Avec ramasse miettes et support couteau. Couteau non fourni.

| | |
|------------------|-------------------------------|
| Planche à pain | P.U |
| 23 x 40 x 3,5 cm | 1 114239 39,51€ |

PINTCH'O



| | | |
|---------------------------|-----------------|---------------|
| Méga planche avec poignée | Acacia | P.U |
| 50 x 15 cm | 1 116277 | 24,00€ |

PINTCH'O



| | | |
|----------------|-----------------|---------------|
| Planche ronde | Bois | P.U |
| Ø 27 x H 25 cm | 1 116278 | 38,04€ |



| | | |
|------------------------------|-----------------|---------------|
| Plateaux présentation ovales | Naturel bois | P.U |
| 50,8 x 20,3 x 1,9 cm | 6 116280 | 29,75€ |
| 40,6 x 20,3 x 1,9 cm | 6 116279 | 28,00€ |



| | | |
|--------------------|------------------|---------------|
| Planche à découper | Naturel bambou | P.U |
| 40 x 30 x 3 cm | 10 116283 | 16,86€ |



| | | |
|--------------------------------------|-----------------|---------------|
| Plateaux présentation rectangulaires | Naturel bois | P.U |
| 56 x 20,3 x 1,9 cm | 6 116281 | 22,82€ |
| 40,6 x 25,5 x 1,9 cm | 6 116282 | 24,65€ |



LE BUFFET

Verres et verrines



N'OUBLIEZ PAS QUE VOS VERRINES SONT RÉUTILISABLES

Avec un large choix de verrines et de mises en bouches, vous disposerez d'une gamme variée et originale pour tous vos événements..

| Cuillères - Verrines | | | P.U |
|---|-----|--------|--------|
| Ø 6,5 x H 1,5 cm - par 100 - Plato Orega | 10 | 299654 | 9,17€ |
| Cuillères - Verrines | | | P.U |
| 6,3 x 6,3 x 1,5 cm - par 100 - Cuadro Transparent | 7.2 | 299652 | 9,67€ |
| Dimension | | | P.U |
| 6,3 x 6,3 x 1,5 cm - par 100 - Cuadro Noir | 7.2 | 124656 | 9,67€ |
| Cuillères - Verrines | | | P.U |
| 12 x 3,2 cm - par 1000 - Cuillère Hong Kong | 2 | 200999 | 61,22€ |



| Cuillères - Verrines | | | P.U |
|--|---|--------|--------|
| 15 cl - 6,3 x 5 cm - par 100 - Sphère | 1 | 203829 | 64,45€ |
| 8 cl - Ø 4,7 x H 8,1 cm - par 100 - Cylindre | 6 | 203866 | 20,51€ |
| 6,5 cl - 4,2 x 4,2 x 4,2 cm - par 100 - Cub | 2 | 200360 | 12,22€ |



| Cuillères - Verrines | | | P.U |
|--|------|--------|--------|
| 6 cl - 4,5 x 4,5 x H 5,5 cm - par 100 - Bouquet | 5.76 | 203865 | 12,22€ |
| 6 cl - Ø 5,1 x H 6,5 cm - par 100 - Vase | 2.88 | 299649 | 24,49€ |
| 6 cl - Ø 4,7 x H 4,6 cm - par 100 - Mini verre hexagonal | 8.64 | 299650 | 14,03€ |



| Verre à pied | | Blanc | P.U |
|----------------|---|--------|--------|
| 30 cl - 20 x 1 | 1 | 103062 | 55,96€ |



| Verre Mojito | | Blanc | P.U |
|----------------|---|--------|--------|
| 43 cl - 48 x 1 | 1 | 103061 | 63,70€ |



| Flûte | | Blanc | P.U |
|-------------------|---|--------|--------|
| 10/12 cl - 42 x 1 | 1 | 103060 | 63,70€ |



| Funcup | | Translucide | P.U |
|--------------------|---|-------------|---------|
| 10/12 cl - 500 x 1 | 1 | 103053 | 139,43€ |
| 12/18 cl - 400 x 1 | 1 | 103054 | 121,97€ |
| 20/25 cl - 500 x 1 | 1 | 103055 | 164,50€ |
| 25/33 cl - 500 x 1 | 1 | 103056 | 176,91€ |
| 33/40 cl - 400 x 1 | 1 | 103057 | 208,44€ |
| 40/50 cl - 400 x 1 | 1 | 103058 | 246,40€ |
| 50/60 cl - 300 x 1 | 1 | 103059 | 233,54€ |

L'USAGE UNIQUE

Traiteurs



Plateau en carton

| Dimension | | P.U |
|----------------------|-----------------|---------------|
| 34 x 45,5 cm_Par 100 | 1 201272 | 71,95€ |
| 28 x 32 cm_Par 100 | 1 201048 | 59,97€ |



Plateau pour repas

| Dimension | | P.U |
|---------------------------------|-----------------|---------------|
| 30 x 24 x 4 cm,5 cpts (4x50) | 1 108125 | 86,72€ |
| Couvercle fibre de canne (4x50) | 1 108126 | 56,42€ |



DENTELLE

Lot de 250
Dentelles ronde

| | Blanc | P.U |
|---------|-----------------|---------------|
| Ø 32 cm | 1 201036 | 30,00€ |
| Ø 28 cm | 1 201035 | 43,69€ |
| Ø 24 cm | 1 201034 | 36,16€ |
| Ø 19 cm | 1 201033 | 23,96€ |
| Ø 17 cm | 1 201032 | 20,98€ |
| Ø 15 cm | 1 201031 | 18,07€ |
| Ø 12 cm | 1 201030 | 14,37€ |
| Ø 10 cm | 1 201029 | 13,21€ |



Lot de 250
Dentelles rectangulaire

| | Blanc | P.U |
|------------|-----------------|---------------|
| 35 x 45 cm | 1 201040 | 47,10€ |
| 30 x 40 cm | 1 201039 | 40,02€ |
| 25 x 35 cm | 1 201038 | 61,18€ |



Cagettes en carton ondulé

Paquet de 50

| Dimension | | P.U |
|---------------------|-----------------|---------------|
| 64 x 42 cm - H 9 cm | 1 103063 | 62,36€ |



Paquet de 50

| Boîtes à entremets en carton | Blanc | P.U |
|------------------------------|-----------------|---------------|
| 35 x 35 cm - H 8 cm | 1 103077 | 32,27€ |
| 32 x 32 cm - H 8 cm | 1 103076 | 47,22€ |
| 28 x 28 cm - H 8 cm | 1 103075 | 37,13€ |
| 25 x 25 cm - H 8 cm | 1 103074 | 29,51€ |

Paquet de 50

| Boîtes à entremets en carton | Blanc | P.U |
|------------------------------|-----------------|---------------|
| 22 x 22 cm - H 8 cm | 1 103073 | 25,42€ |
| 20 x 20 cm - H 8 cm | 1 103072 | 20,90€ |
| 18 x 18 cm - H 8 cm | 1 103071 | 16,76€ |
| 16 x 16 cm - H 8 cm | 1 103070 | 15,61€ |

L'USAGE UNIQUE

Traiteurs



OR ET NOIR

Carton double face

| Disques | 📦 | | P.U |
|-------------------|---|---------------|---------------|
| Ø 40 cm - par 100 | 1 | 116307 | 80,19€ |
| Ø 36 cm - par 100 | 1 | 116306 | 66,70€ |
| Ø 34 cm - par 100 | 1 | 116305 | 63,99€ |
| Ø 32 cm - par 100 | 1 | 116304 | 52,27€ |
| Ø 28 cm - par 100 | 1 | 116303 | 33,86€ |
| Ø 26 cm - par 100 | 1 | 116302 | 31,77€ |
| Ø 24 cm - par 100 | 1 | 116301 | 26,11€ |
| Ø 22 cm - par 100 | 1 | 116300 | 22,02€ |
| Ø 20 cm - par 100 | 1 | 116299 | 17,16€ |
| Ø 18 cm - par 100 | 1 | 116298 | 14,11€ |



Carton double face

| Carré avec angles arrondis | 📦 | | P.U |
|----------------------------|-----|---------------|---------------|
| 32 x 32 cm - par 100 | 0,5 | 116297 | 57,59€ |
| 28 x 28 cm - par 100 | 0,5 | 116296 | 45,20€ |
| 24 x 24 cm - par 100 | 0,5 | 116295 | 34,48€ |
| 22 x 22 cm - par 100 | 0,5 | 116294 | 27,62€ |
| 20 x 20 cm - par 100 | 0,5 | 116293 | 24,49€ |
| 18 x 18 cm - par 100 | 0,5 | 116292 | 20,72€ |



| Mini formes | 📦 | | P.U |
|----------------------------|---|---------------|--------------|
| 8 x 8 (2 + 2) cm - par 100 | 2 | 116289 | 8,53€ |

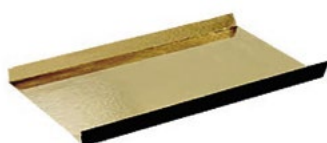

| Fonds pliés Mini formes | 📦 | | P.U |
|-----------------------------|---|---------------|--------------|
| 10 x 4,5 + 1,5 cm - par 100 | 2 | 116290 | 5,44€ |
| 13 x 4,5 + 1,5 cm - par 100 | 2 | 116291 | 7,65€ |



| Mini formes | 📦 | | P.U |
|------------------|---|---------------|---------------|
| Ø 8 cm - par 100 | 2 | 116288 | 10,38€ |

L'USAGE UNIQUE

Traiteurs



Carton double face
Dentelles en carton dur

| | Q | | P.U |
|----------------------|-----|---------------|---------------|
| 27 x 27 cm - par 100 | 0.5 | 116315 | 48,59€ |
| 24 x 24 cm - par 100 | 0.5 | 116314 | 40,76€ |
| 21 x 21 cm - par 100 | 0.5 | 116313 | 33,22€ |
| 19 x 19 cm - par 100 | 0.5 | 116312 | 29,09€ |



Carton double face
Bases pour biscuits et gâteaux roulés

| | Q | | P.U |
|----------------------|-----|---------------|---------------|
| 40 x 10 cm - par 100 | 0.5 | 116311 | 20,39€ |
| 30 x 10 cm - par 100 | 0.5 | 116310 | 15,74€ |



Carton double face
Barquettes

| | Q | | P.U |
|----------------------------|-----|---------------|---------------|
| 22 x 14 x 3,5 cm - par 100 | 2.5 | 116309 | 39,80€ |
| 13 x 9 x 3,5 cm - par 100 | 2.5 | 116308 | 18,00€ |



Carton double face
Mini formes

| | Q | | P.U |
|------------------------|-----|---------------|--------------|
| Ø 8 cm - par 100 | 2.5 | 116284 | 8,25€ |
| 8 x 8 cm - par 100 | 2.5 | 116285 | 8,25€ |
| 5,5 x 9,5 cm - par 100 | 2.5 | 116286 | 7,99€ |
| 4,5 x 13 cm - par 100 | 2.5 | 116287 | 9,17€ |



L'USAGE UNIQUE

Nappes & serviettes



| Nappe papier gaufré | Blanc | P.U |
|---------------------|-------|----------------------|
| 70 x 110 cm_Par 500 | 1 | 277111 45,56€ |
| 70 x 70 cm_Par 500 | 1 | 277701 29,61€ |
| 80 x 80 cm_Par 500 | 1 | 278801 38,54€ |
| 80 x 120 cm_Par 250 | 1 | 278121 27,85€ |
| 60 x 60 cm_Par 500 | 1 | 277700 25,94€ |



| Rouleau nappe papier damassé | Blanc | P.U |
|------------------------------|-------|----------------------|
| 1,20 x 100 m_Par 4 | 1 | 270001 62,43€ |
| 1,20 x 10 m_Par 30 | 1 | 270011 57,76€ |



SERVIETTE OUATE BLANCHE



| 1 pli décalé | 12 x 250 | P.U |
|--------------|----------|----------------------|
| 29 x 29 cm | 1 | 273331 30,87€ |
| 1 pli | 32 x 100 | P.U |
| 29 x 29 cm | 1 | 201943 29,81€ |
| 2 plis | 18 x 100 | P.U |
| 40 x 40 cm | 1 | 274201 41,34€ |
| 2 plis | 16 x 200 | P.U |
| 30 x 30 cm | 1 | 273321 39,72€ |

SERVIETTE OUATE



| Serviette pochette ouate | 18 x 100 | P.U | Serviette pochette ouate | 18 x 100 | P.U |
|--------------------------|----------|----------------------|--------------------------|----------|----------------------|
| ● Béton - 39 x 39 cm | 1 | 299609 58,42€ | ● Ivoire - 39 x 39 cm | 1 | 103084 58,42€ |
| ● Abricot - 39 x 39 cm | 1 | 103082 58,42€ | ● Jaune - 39 x 39 cm | 1 | 103085 58,42€ |
| ● Bleu azur - 39 x 39 cm | 1 | 274204 58,42€ | ● Vanille - 39 x 39 cm | 1 | 274206 58,42€ |
| ● Lavande - 39 x 39 cm | 1 | 299612 58,42€ | | | |
| ● Pistache - 39 x 39 cm | 1 | 299614 58,42€ | | | |



SERVIETTE POCLETTE OUATE

| Dimension | Kraft ébène / Kraft | P.U | Kraft brun / Chocolat | P.U | Anthracite / Blanc | P.U |
|------------|---------------------|----------------------|-----------------------|----------------------|--------------------|-----|
| 23 x 39 cm | 1 | 107996 69,21€ | 103081 55,10€ | 103079 63,93€ | | |

N'HESITEZ PAS à nous consulter
PERSONNALISATION POSSIBLE
NOMBREUSES RÉFÉRENCES & COLORIS DISPONIBLES
 ÉGALEMENT EN CAS DE COTATION POUR VOLUME IMPORTANT

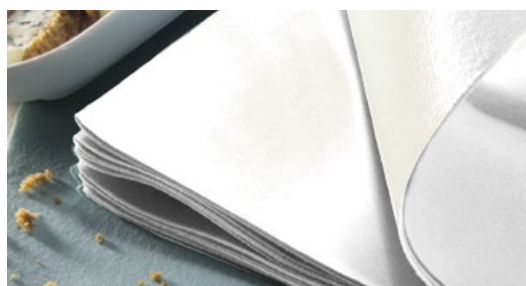

R'SOFT®

La qualité de serviette non tissé R'Soft est une qualité de serviette dite en voie sèche pour une utilisation courante à un prix attractif en alternative au tissu. Idéal pour les brasseries, restaurants, restaurants d'entreprises...
 Grammage 60 grs/m2.

| Serviette blanche | 16 x 50 | P.U |
|-------------------|---------|----------------------|
| 40 x 40 cm | 1 | 200971 71,10€ |

L'USAGE UNIQUE

Nappes & serviettes

GAMME CELISOFT®

| Rouleau uni | 📦 | 1,20 x 25 m | P.U |
|---------------|---|---------------|---------------|
| ○ Blanc | 1 | 200981 | 17,41€ |
| ● Bleu azur | 1 | 200982 | 26,48€ |
| ● Citron | 1 | 103091 | 28,43€ |
| ● Ivoire | 1 | 200983 | 26,48€ |
| ● Bleu marine | 1 | 200987 | 28,58€ |
| ● Bordeaux | 1 | 200988 | 28,58€ |
| ● Rouge | 1 | 200989 | 28,58€ |
| ● Vert sapin | 1 | 200990 | 28,58€ |
| ● Mandarine | 1 | 200986 | 28,58€ |
| ● Ebène | 1 | 200991 | 28,58€ |
| ● Chocolat | 1 | 200992 | 28,58€ |
| ● Béton | 1 | 200984 | 26,48€ |
| ● Lin | 1 | 200985 | 26,48€ |
| ● Chartreuse | 1 | 103090 | 28,43€ |
| ● Argile | 1 | 103093 | 30,70€ |
| ● Framboise | 1 | 103097 | 30,70€ |
| ● Rose poudré | 1 | 103092 | 28,43€ |
| ● Titane | 1 | 103095 | 30,70€ |
| ● Caramel | 1 | 103089 | 28,43€ |
| ● Bleu orage | 1 | 103094 | 30,70€ |
| ● Figue | 1 | 103096 | 30,70€ |

GAMME CELISOFT®

| Serviette | 📦 | 16 x 50 | P.U |
|----------------------------|---|---------------|----------------|
| ○ Blanc - 40 x 40 cm | 1 | 203876 | 91,96€ |
| ● Bleu azur - 40 x 40 cm | 1 | 203879 | 144,58€ |
| ● Citron - 40 x 40 cm | 1 | 203881 | 144,58€ |
| ● Ivoire - 40 x 40 cm | 1 | 203882 | 144,58€ |
| ● Bleu marine - 40 x 40 cm | 1 | 203887 | 142,27€ |
| ● Bordeaux - 40 x 40 cm | 1 | 203888 | 142,27€ |
| ● Rouge - 40 x 40 cm | 1 | 203895 | 142,27€ |
| ● Vert sapin - 40 x 40 cm | 1 | 203898 | 142,27€ |
| ● Mandarine - 40 x 40 cm | 1 | 203893 | 142,27€ |
| ● Argile - 40 x 40 cm | 1 | 203885 | 142,27€ |
| ● Framboise - 40 x 40 cm | 1 | 203891 | 142,27€ |
| ● Titane - 40 x 40 cm | 1 | 103103 | 142,27€ |
| ● Ebène - 40 x 40 cm | 1 | 203890 | 142,27€ |
| ● Bleu orage - 40 x 40 cm | 1 | 103101 | 142,27€ |
| ● Chocolat - 40 x 40 cm | 1 | 203889 | 142,27€ |
| ● Caramel - 40 x 40 cm | 1 | 103098 | 118,29€ |
| ● Chartreuse - 40 x 40 cm | 1 | 103099 | 118,29€ |
| ● Figue - 40 x 40 cm | 1 | 103102 | 142,27€ |
| ● Rose poudré - 40 x 40 cm | 1 | 103100 | 118,29€ |
| ● Béton - 40 x 40 cm | 1 | 203878 | 118,29€ |
| ● Lin - 40 x 40 cm | 1 | 203883 | 118,29€ |

GAMME SET DE TABLE

| Papier gaufré, bord droit | 📦 | Par 1000 | P.U |
|----------------------------|---|---------------|---------------|
| ● Rouge - 30 x 40 cm | 1 | 203303 | 32,51€ |
| ● Vert foncé - 30 x 40 cm | 1 | 203304 | 32,51€ |
| ● Jaune vif - 30 x 40 cm | 1 | 203305 | 32,51€ |
| ● Bleu marine - 30 x 40 cm | 1 | 203306 | 32,51€ |
| ● Bordeaux - 30 x 40 cm | 1 | 203308 | 32,51€ |
| ● Chocolat - 30 x 40 cm | 1 | 203311 | 32,51€ |
| ● Fuchsia - 30 x 40 cm | 1 | 203312 | 32,51€ |
| ● Gris argent - 30 x 40 cm | 1 | 203313 | 32,51€ |
| ● Ivoire - 30 x 40 cm | 1 | 203314 | 32,51€ |
| ● Mandarine - 30 x 40 cm | 1 | 203315 | 32,51€ |
| ● Prune - 30 x 40 cm | 1 | 203316 | 32,51€ |
| ● Turquoise - 30 x 40 cm | 1 | 203318 | 32,51€ |
| ● Vert anis - 30 x 40 cm | 1 | 203319 | 32,51€ |



LE TEXTILE

Sets & Porte-couverts



2 faces - 100% PVC effet tissu

Set 2 faces coins arrondis

| | 20 | P.U | | 20 | P.U |
|---------------------------------|----|---------------|---------------|--------------------------------------|--------------------------------|
| ● Terracotta/beige - 33 x 43 cm | 20 | 103104 | 20,13€ | ● Rouge/beige - 33 x 43 cm | 20 103108 20,13€ |
| ● Taupe/beige - 33 x 43 cm | 20 | 103105 | 20,13€ | ● Noir/beige - 33 x 43 cm | 20 103109 20,13€ |
| ● Sauge/beige - 33 x 43 cm | 20 | 103106 | 20,13€ | ● Vintage cacao/grège - 33 x 43 cm | 20 103110 20,13€ |
| ● Acier/beige - 33 x 43 cm | 20 | 103107 | 20,13€ | ● Vintage ardoise/grège - 33 x 43 cm | 20 103111 20,13€ |



2 faces - 100% PVC effet tissu

Set 2 faces ovoïde

| | 20 | P.U | | 20 | P.U |
|---------------------------------|----|---------------|---------------|--------------------------------------|--------------------------------|
| ● Terracotta/beige - 33 x 43 cm | 20 | 103112 | 14,99€ | ● Rouge/beige - 33 x 43 cm | 20 103116 14,99€ |
| ● Taupe/beige - 33 x 43 cm | 20 | 103113 | 14,99€ | ● Noir/beige - 33 x 43 cm | 20 103117 14,99€ |
| ● Sauge/beige - 33 x 43 cm | 20 | 103114 | 14,99€ | ● Vintage cacao/grège - 33 x 43 cl | 20 103118 14,99€ |
| ● Acier/beige - 33 x 43 cm | 20 | 103115 | 14,99€ | ● Vintage ardoise/grège - 33 x 43 cm | 20 103119 15,37€ |

2 faces - 100% PVC effet tissu

Porte-couverts 2 faces

| | 20 | P.U |
|--------------------------------------|----|-----------------------------|
| ● Terracotta/beige - 10 x 24 cm | 20 | 103120 10,18€ |
| ● Taupe/beige - 10 x 24 cm | 20 | 103121 10,18€ |
| ● Sauge/beige - 10 x 24 cm | 20 | 103122 10,18€ |
| ● Acier/beige - 10 x 24 cm | 20 | 103123 10,18€ |
| ● Rouge/beige - 10 x 24 cm | 20 | 103124 10,18€ |
| ● Noir/ beige - 10 x 24 cm | 20 | 103125 10,18€ |
| ● Vintage cacao/grège - 10 x 24 cm | 20 | 103126 10,18€ |
| ● Vintage ardoise/grège - 10 x 24 cm | 20 | 103127 10,18€ |



LE TEXTILE

Pensez à nous consulter, nous étudions avec vous votre projet personnalisé avec notre partenaire français.



NAPPES, CHEMINS
SERVIETTES,
SETS DE TABLE
PANIÈRES
ACCESSOIRES DE TABLE
TABLIERS

SONO LYS



Made in
France



Personnalisable



Artisanat
familial



Résistant &
réutilisable



LE TEXTILE

Vêtement Homme

GILET YOUN'Z

Coupe ajustée, style sobre et élégant, adoptez un look «sport chic» avec Youn'z. La matière utilisée apporte un aspect haut de gamme se rapprochant d'un toucher lainage.

Encolure V, fermeture 5 boutons, pinces poitrine, bas arrondi, 2 poches basses passepoilées, 1 poche intérieure, découpe dos, patte de serrage dos. 64% polyester 34% viscose 2% spandex.



| Taille | ● | | P.U |
|--------|----|---------------|---------------|
| T.0 | 35 | 116367 | 49,74€ |
| T.1 | 35 | 116366 | 49,74€ |
| T.2 | 35 | 116365 | 49,74€ |
| T.3 | 35 | 116364 | 49,74€ |
| T.4 | 35 | 116363 | 49,74€ |
| T.5 | 35 | 116362 | 49,74€ |
| T.6 | 35 | 116361 | 49,74€ |
| T.7 | 35 | 116360 | 64,66€ |

PANTALON YOUN'Z

Coupe ajustée, style sobre et élégant, adoptez un look «sport chic» avec Youn'z. La matière utilisée apporte un aspect haut de gamme se rapprochant d'un toucher lainage.

Ceinture 6 passants fermée par un bouton apparent et un bouton intérieur, braguette zippée, 2 poches italiennes devant, 1 poche passepoilée dos avec ruban gros grain, pinces dos, bas non terminé. 64% polyester 34% viscose 2% spandex.



| Taille | ● | ● | ● | ● | P.U |
|--------|----|---------------|---------------|---------------|---------------|
| | | Gris Chiné | Noir | Marine | |
| T.60 | 20 | 116316 | 116331 | 116346 | 40,03€ |
| T.58 | 20 | 116317 | 116332 | 116347 | 40,03€ |
| T.56 | 20 | 116318 | 116333 | 116348 | 40,03€ |
| T.54 | 20 | 116319 | 116334 | 116349 | 40,03€ |
| T.52 | 20 | 116320 | 116335 | 116350 | 40,03€ |
| T.50 | 20 | 116321 | 116336 | 116351 | 40,03€ |
| T.48 | 20 | 116322 | 116337 | 116352 | 40,03€ |
| T.46 | 20 | 116323 | 116338 | 116353 | 40,03€ |
| T.44 | 20 | 116324 | 116339 | 116354 | 40,03€ |
| T.42 | 20 | 116325 | 116340 | 116355 | 40,03€ |
| T.40 | 20 | 116326 | 116341 | 116356 | 40,03€ |
| T.38 | 20 | 116327 | 116342 | 116357 | 40,03€ |
| T.36 | 20 | 116328 | 116343 | 116358 | 40,03€ |
| T.34 | 20 | 116329 | 116344 | 116359 | 40,03€ |
| T.62 | 20 | - | 116330 | 116345 | 40,03€ |

VESTE YOUN'Z

Coupe ajustée, style sobre et élégant, adoptez un look «sport chic» avec Youn'z. La matière utilisée apporte un aspect haut de gamme se rapprochant d'un toucher lainage.

Col tailleur avec découpe et 1 fausse boutonnière, fermeture 2 boutons, 2 pinces devant, bas arrondi, 2 poches basses inclinées passepoilées avec rabat, poches intérieures, fente dos. 64% polyester 34% viscose 2% spandex.



| Taille | ● | ● | ● | P.U | |
|--------|---|---------------|---------------|---------------|----------------|
| | | Noir | Gris Chiné | Marine | |
| T.34 | 5 | 116397 | 116382 | 116412 | 112,48€ |
| T.36 | 5 | 116396 | 116381 | 116411 | 112,48€ |
| T.38 | 5 | 116395 | 116380 | 116410 | 112,48€ |
| T.40 | 5 | 116394 | 116379 | 116409 | 112,48€ |
| T.42 | 5 | 116393 | 116378 | 116408 | 112,48€ |
| T.44 | 5 | 116392 | 116377 | 116407 | 112,48€ |
| T.46 | 5 | 116391 | 116376 | 116406 | 112,48€ |
| T.48 | 5 | 116390 | 116375 | 116405 | 112,48€ |
| T.50 | 5 | 116389 | 116374 | 116404 | 112,48€ |
| T.52 | 5 | 116388 | 116373 | 116403 | 112,48€ |
| T.54 | 5 | 116387 | 116372 | 116402 | 112,48€ |
| T.56 | 5 | 116386 | 116371 | 116401 | 112,48€ |
| T.58 | 5 | 116385 | 116370 | 116400 | 112,48€ |
| T.60 | 5 | 116384 | 116369 | 116399 | 112,48€ |
| T.62 | 5 | 116383 | 116368 | 116398 | 112,48€ |

LE TEXTILE

Vêtement Mixte

PANTALON CHINO

- Pantalon homme :
- Ceinture avec passants
 - Matière effet peau de pêche
 - Finition intérieures contrastées

- Boutons effet corne satiné + zip
- 2 poches italiennes devant
- 1 poche passepoilée au dos
- Biais contrastés en revers de bas de pantalons



| Taille | | ● Marine | ● Gris | ● Noir | P.U | | ● Beige | P.U |
|--------|---|----------|--------|--------|--------|---|---------|--------|
| T.34 | 1 | 102821 | 116482 | 102807 | 41,95€ | 1 | 116496 | 41,95€ |
| T.36 | 1 | 102822 | 116481 | 102808 | 41,95€ | 1 | 116495 | 41,95€ |
| T.38 | 1 | 102823 | 116480 | 102809 | 41,95€ | 1 | 116494 | 41,95€ |
| T.40 | 1 | 102824 | 116479 | 102810 | 41,95€ | 1 | 116493 | 41,95€ |
| T.42 | 1 | 102825 | 116478 | 102811 | 41,95€ | 1 | 116492 | 41,95€ |
| T.44 | 1 | 102826 | 116477 | 102812 | 41,95€ | 1 | 116491 | 41,95€ |
| T.46 | 1 | 102827 | 116476 | 102813 | 41,95€ | 1 | 116490 | 41,95€ |
| T.48 | 1 | 102828 | 116475 | 102814 | 41,95€ | 1 | 116489 | 41,95€ |
| T.50 | 1 | 102829 | 116474 | 102815 | 41,95€ | 1 | 116488 | 41,95€ |
| T.52 | 1 | 102830 | 116473 | 102816 | 41,95€ | 1 | 116487 | 41,95€ |
| T.54 | 1 | 102831 | 116472 | 102817 | 41,95€ | 1 | 116486 | 41,95€ |
| T.56 | 1 | 102832 | 116471 | 102818 | 41,95€ | 1 | 116485 | 41,95€ |
| T.58 | 1 | 102833 | 116470 | 102819 | 41,95€ | 1 | 116484 | 41,95€ |
| T.60 | 1 | 102834 | 116469 | 102820 | 41,95€ | 1 | 116483 | 41,95€ |

PANTALON CHIARA

- Pantalon femme :
- Ceinture avec passants
 - Matière effet peau de pêche
 - Finitions intérieures contrastées
 - Boutons effet corne satinés + zip

- 2 poches italiennes devant
- 1 poche passepoilée dos
- Biais contrastés en revers de bas de pantalon
- Coton / Elasthanne



| Taille | | ● Marine | ● Noir | P.U |
|--------|---|----------|--------|--------|
| T.34 | 1 | 115102 | 115115 | 40,31€ |
| T.36 | 1 | 115103 | 115116 | 40,31€ |
| T.38 | 1 | 115104 | 115117 | 40,31€ |
| T.40 | 1 | 115105 | 115118 | 40,31€ |
| T.42 | 1 | 115106 | 115119 | 40,31€ |
| T.44 | 1 | 115107 | 115120 | 40,31€ |
| T.46 | 1 | 115108 | 115121 | 40,31€ |
| T.48 | 1 | 115109 | 115122 | 40,31€ |
| T.50 | 1 | 115110 | 115123 | 40,31€ |
| T.52 | 1 | 115111 | 115124 | 40,31€ |
| T.54 | 1 | 115112 | 115125 | 40,31€ |
| T.56 | 1 | 115113 | 115126 | 40,31€ |
| T.58 | 1 | 115114 | 115127 | 40,31€ |

LE TEXTILE

Vêtement Mixte



CHEMISE ASTI

Manche longue

Chemise homme :

- Col chemise
- Coupe ajustée
- Pied de col fermé par un bouton cousu
- Boutons cousus

| Taille | | ● Noir | ● Bleu ciel | P.U |
|--------|---|-----------|----------------|--------|
| T.36 | 1 | 116461 | 116468 | 27,94€ |
| T.38 | 1 | 116460 | 116467 | 27,94€ |
| T.40 | 1 | 116459 | 116466 | 27,94€ |
| T.42 | 1 | 116458 | 116465 | 27,94€ |
| T.44 | 1 | 116457 | 116464 | 27,94€ |
| T.46 | 1 | 116456 | 116463 | 27,94€ |
| T.48 | 1 | 116455 | 116462 | 27,94€ |

CHEMISE TERA

Manche longue

Chemise femme :

- Pied de col fermé par un bouton cousu
- Chemisier ajusté
- Boutons cousus
- Poignets fermés par boutons cousus (réglables)
- Fentes côtés



| Taille | | ● Noir | ● Bleu ciel | ○ Blanc | P.U |
|--------|---|-----------|----------------|------------|--------|
| T.34 | 1 | 116426 | 116440 | 116454 | 27,94€ |
| T.36 | 1 | 116425 | 116439 | 116453 | 27,94€ |
| T.38 | 1 | 116424 | 116438 | 116452 | 27,94€ |
| T.40 | 1 | 116423 | 116437 | 116451 | 27,94€ |
| T.42 | 1 | 116422 | 116436 | 116450 | 27,94€ |
| T.44 | 1 | 116421 | 116435 | 116449 | 27,94€ |
| T.46 | 1 | 116420 | 116434 | 116448 | 27,94€ |
| T.48 | 1 | 116419 | 116433 | 116447 | 27,94€ |
| T.50 | 1 | 116418 | 116432 | 116446 | 27,94€ |
| T.52 | 1 | 116417 | 116431 | 116445 | 27,94€ |
| T.54 | 1 | 116416 | 116430 | 116444 | 27,94€ |
| T.56 | 1 | 116415 | 116429 | 116443 | 27,94€ |
| T.58 | 1 | 116414 | 116428 | 116442 | 27,94€ |
| T.60 | 1 | 116413 | 116427 | 116441 | 27,94€ |

LE TEXTILE

Vêtement Mixte

TABLIER ROB

100% polyester effet peau tannée.



| Couleur | 📦 | | P.U. |
|--------------------|---|---------------|---------------|
| ● Cuirlys chocolat | 6 | 103138 | 45,24€ |
| ● Cuirlys caramel | 6 | 103135 | 45,24€ |
| ● Cuirlys gris | 6 | 103137 | 45,24€ |
| ● Cuirlys vanille | 6 | 103136 | 45,24€ |

TABLIER KAT

100% polyester effet peau tannée.



| Couleur | 📦 | | P.U. |
|--------------------|---|---------------|---------------|
| ● Cuirlys chocolat | 6 | 103140 | 28,28€ |
| ● Cuirlys caramel | 6 | 103141 | 28,28€ |
| ● Cuirlys gris | 6 | 103142 | 28,28€ |
| ● Cuirlys vanille | 6 | 103143 | 28,28€ |



TABLIER DE SERVICE DAN

| Couleur | 📦 | Taille unique. | P.U. |
|---------------------|------|----------------|---------------|
| ● Beige | 30 | 103128 | 24,08€ |
| ● Gris | 30 | 103129 | 24,08€ |
| ● Melon | 30 | 300483 | 24,07€ |
| ● Framboise | 30 | 300484 | 24,07€ |
| ● Rouge Vif | 30 | 300485 | 24,07€ |
| ● Vert | #N/A | 103130 | 22,72€ |
| ● Anis | 30 | 300487 | 24,07€ |
| ● Chocolat | 30 | 103131 | 24,08€ |
| ● Noir | 30 | 103132 | 24,08€ |
| ● Rayé noir / blanc | 30 | 103133 | 28,30€ |



CEINTURE TABLIER AMA

| Dimension | 📦 | | P.U. |
|----------------------------|----|---------------|---------------|
| 65 % polyester/ 35 % coton | 40 | 364596 | 20,79€ |



LITEAU FIDJI

| Dimension | 📦 | | P.U. |
|--------------------------------------|---|---------------|---------------|
| 70 x 55 cm - Ourlets piqués - par 12 | 1 | 109633 | 41,88€ |

LE TEXTILE

Chaussures

SOLÈNE

Ce modèle possède une semelle HEXAGRIP ultra antidérapante. Chaussure de service pour femme, en microfibre.



| Taille | | Noir | P.U |
|--------|---|--------|--------|
| T. 35 | 1 | 205357 | 62,75€ |
| T. 36 | 1 | 205356 | |
| T. 37 | 1 | 205355 | |
| T. 38 | 1 | 205354 | |
| T. 39 | 1 | 205353 | |
| T. 40 | 1 | 205352 | |
| T. 41 | 1 | 205351 | |
| T. 42 | 1 | 205350 | |

MAXIME

Chaussure de service coquée, mixte. Composition en microfibre.



| Taille | | Noir | P.U |
|--------|---|--------|--------|
| T. 36 | 1 | 204998 | 55,74€ |
| T. 37 | 1 | 204997 | |
| T. 38 | 1 | 204996 | |
| T. 39 | 1 | 204995 | |
| T. 40 | 1 | 204994 | |
| T. 41 | 1 | 204993 | |
| T. 42 | 1 | 204992 | |
| T. 43 | 1 | 204991 | |
| T. 44 | 1 | 204990 | |
| T. 45 | 1 | 204989 | |
| T. 46 | 1 | 204988 | |
| T. 47 | 1 | 204987 | |

SARA

Chaussure de service pour femme, type ballerine. Talon de 1,5cm.



| Taille | | Noir | P.U |
|--------|---|--------|--------|
| T. 35 | 1 | 205349 | 44,50€ |
| T. 36 | 1 | 205348 | |
| T. 37 | 1 | 205347 | |
| T. 38 | 1 | 205346 | |
| T. 39 | 1 | 205345 | |
| T. 40 | 1 | 205344 | |
| T. 41 | 1 | 205343 | |
| T. 42 | 1 | 205342 | |

SANDY

Escarpin de service, talon 4cm. Composition microfibre.



| Taille | | Noir | P.U |
|--------|---|--------|--------|
| T. 35 | 1 | 205341 | 46,37€ |
| T. 36 | 1 | 205340 | |
| T. 37 | 1 | 205339 | |
| T. 38 | 1 | 205338 | |
| T. 39 | 1 | 205337 | |
| T. 40 | 1 | 205336 | |
| T. 41 | 1 | 205335 | |
| T. 42 | 1 | 205334 | |

MAEL MONTANT

Basket professionnelle sans embout, confectionnée en cuir pour une chaussure souple. Tenue parfaite sur tous les types de surfaces



| Taille | | Blanc | Noir | P.U |
|--------|---|--------|--------|---------|
| T. 35 | 1 | 116497 | 116511 | 114,76€ |
| T. 36 | 1 | 116498 | 116512 | |
| T. 37 | 1 | 116499 | 116513 | |
| T. 38 | 1 | 116500 | 116514 | |
| T. 39 | 1 | 116501 | 116515 | |
| T. 40 | 1 | 116502 | 116516 | |
| T. 41 | 1 | 116503 | 116517 | |
| T. 42 | 1 | 116504 | 116518 | |
| T. 43 | 1 | 116505 | 116519 | |
| T. 44 | 1 | 116506 | 116520 | |
| T. 45 | 1 | 116507 | 116521 | |
| T. 46 | 1 | 116508 | 116522 | |
| T. 47 | 1 | 116509 | 116523 | |
| T. 48 | 1 | 116510 | 116524 | |

MAEL

Chaussure en cuir, sans embout. Semelle extérieure (technologie Extragrip®), avec une double densité en caoutchouc & EVA.



| Taille | | Blanc | Noir | P.U |
|--------|---|--------|--------|---------|
| T. 35 | 1 | 210951 | 210964 | 100,79€ |
| T. 36 | 1 | 210952 | 210965 | |
| T. 37 | 1 | 210953 | 210966 | |
| T. 38 | 1 | 210954 | 210967 | |
| T. 39 | 1 | 210955 | 210968 | |
| T. 40 | 1 | 210956 | 210969 | |
| T. 41 | 1 | 210957 | 210970 | |
| T. 42 | 1 | 210958 | 210971 | |
| T. 43 | 1 | 210959 | 210972 | |
| T. 44 | 1 | 210960 | 210973 | |
| T. 45 | 1 | 210961 | 210974 | |
| T. 46 | 1 | 210962 | 210975 | |
| T. 47 | 1 | 210963 | 210976 | |

A - E

A

| | |
|--------------------------------------|--------|
| Accessoire pour machine à pâtes..... | 35 |
| Adaptateur pour balance..... | 46 |
| Aiguiseur..... | 23 |
| Araignée..... | 31 |
| Aspirateur..... | 86 |
| Assiettes..... | 65, 72 |
| Autolaveuse..... | 86 |
| Aiguille à brider..... | 23 |
| Attendrisseur..... | 23 |

B

| | |
|------------------------------|-------------|
| Bac amovible..... | 89 |
| Bac à ingrédients..... | 55 |
| Bac à pâtons..... | 57 |
| Bac plat..... | 57 |
| Bac gastronomique..... | 48, 49 |
| Balance..... | 46 |
| Balais..... | 87 |
| Barquette..... | 67 à 69, 71 |
| Barre aimantée..... | 23 |
| Barrette de composition..... | 48 |
| Basket..... | 109 |
| Bassine demi-sphérique..... | 36 |
| Bassine pâtissière..... | 36 |
| Berceuse inox..... | 22 |
| Bobine..... | 23, 78, 79 |
| Boîte à ingrédients..... | 55 |
| Boîte à pizza..... | 70 |
| Boîte découpoirs..... | 35 |
| Boîte hermétique..... | 47 |
| Boisson chaude..... | 59, 50 |
| Botte..... | 108 |
| Braisière..... | 7 |
| Brosse..... | 44 |
| Brûleur..... | 15 |
| Brasero..... | 15 |

C

| | |
|-----------------------------|---------------|
| Cadre pâtissier..... | 41 |
| Caillebotis..... | 58 |
| Caisse à génoise..... | 39 |
| Caisse de transport..... | 84 |
| Calot..... | 94 |
| Canneleur..... | 24 |
| Casier à verres..... | 80, 85 |
| Casier de lavage..... | 80, 81 |
| Casserole..... | 4, 7, 6, 8, 9 |
| Casserole cuivre..... | 4 |
| Caquelon à fondue..... | 14 |
| Cercle à mousse..... | 42 |
| Cercle à vacherin..... | 42 |
| Chalumeau..... | 43 |
| Chariot à glissières..... | 50 |
| Chariot à linge..... | 90 |
| Chariot cafétéria..... | 50 |
| Chariot de nettoyage..... | 86 |
| Chariot petit déjeuner..... | 61 |
| Chariot plateforme..... | 52 |

| | |
|------------------------------|--|
| Chariot pour conteneurs..... | 64 |
| Chauffe-briques..... | 59 |
| Chaussette..... | 109 |
| Chauffe-eau..... | 60 |
| Chauffe tasses..... | 60 |
| Chaussures..... | 108, 109 |
| Chinois..... | 34 |
| Ciseaux..... | 25, 44 |
| Coffre à linge..... | 91 |
| Collecteur à déchets..... | 89 |
| Collecteur à pédale..... | 88 |
| Container..... | 60, 88 |
| Conteneurs isothermes..... | 62 à 65 |
| Conteneurs poubelles..... | 88, 89 |
| Corbeille à linge..... | 90 |
| Cornes à pâtisserie..... | 36 |
| Coupe-frites..... | 28 |
| Coupe-œuf..... | 25 |
| Coupe-pain..... | 19 |
| Coupe-pâte..... | 36 |
| Coupe-tomates..... | 28 |
| Couperet..... | 22 |
| Couteaux à fromage..... | 22 |
| Coutellerie..... | 16 à 23 |
| Couvercles..... | 5, 6, 7, 48, 52, 54 à 58, 65, 67, 69, 71, 80, 81, 83, 84 |
| Couverts biodégradables..... | 72 |
| Cuillère à arroser..... | 31 |
| Cuit-vapeur..... | 8 |
| Cuve sur roues..... | 52 |
| Cuvette..... | 57 |
| Cuvier..... | 52 |
| Cure dents..... | 73 |

D

| | |
|--------------------------------|--------|
| Découpoir..... | 38 |
| Dérouleur..... | 66 |
| Détartrant..... | 59 |
| Détergent..... | 77, 86 |
| Dévidoir..... | 50 |
| Distributeur à pression..... | 35 |
| Distributeur de savon..... | 78, 79 |
| Distributeur essuie-mains..... | 78, 79 |
| Distributeur pour bobines..... | 78, 79 |
| Distributeur sur pied..... | 78 |
| Diviseur à pâte..... | 36 |
| Douilles..... | 37, 38 |

E

| | |
|----------------------------------|------------|
| Étrogneur..... | 24 |
| Écailleux..... | 25 |
| Écumoire..... | 31 |
| Éminceur à cornichons..... | 24 |
| Entonnoir..... | 34, 35 |
| Éplucheur..... | 24, 25, 29 |
| Esse inox..... | 23 |
| Essoreuse manuelle à salade..... | 27 |
| Essuie-mains..... | 78, 79 |
| Essuie-verre..... | 92 |
| Étiquettes..... | 74 |

F - P

F

| | |
|-----------------------------------|--------------|
| Fil à Lyre..... | 25 |
| Faitout..... | 4 à 6, 9, 14 |
| Feuille parisienne..... | 22 |
| Film alimentaire / aluminium..... | 66 |
| Filtre à huile..... | 75 |
| Flacon verseur..... | 35 |
| Fouet..... | 30, 33 |
| Fourchette de cuisine..... | 14, 24, 33 |
| Frottoir..... | 87 |
| Fusil..... | 22 |
| Fût..... | 54 |

G

| | |
|---------------------------|--------|
| Gant..... | 23, 92 |
| Gilet..... | 103 |
| Gobelets à frites..... | 70 |
| Godet à couverts..... | 81, 82 |
| Gouttière à bûche..... | 41 |
| Grille pour bac..... | 56, 57 |
| Grille de protection..... | 85 |
| Grilles fil inox..... | 45 |
| Grilles pour Brasero..... | 15 |

H

| | |
|--------------------------------|--------|
| Housse de protection..... | 52, 83 |
| Housse lavable et jetable..... | 51 |

I

| | |
|------------------------|----|
| Insert bac gastro..... | 83 |
|------------------------|----|

K

| | |
|---------------------------|----|
| Kit couteau poussoir..... | 28 |
| Kit de rechange..... | 28 |

L

| | |
|-------------------------|--------|
| Lancette à huîtres..... | 25 |
| Lame pour racleur..... | 15 |
| Laitière..... | 60 |
| Laverie..... | 77 |
| Liquide de rinçage..... | 77 |
| Lingettes..... | 76 |
| Louche / Louchette..... | 31, 44 |
| Lyre..... | 25 |

M

| | |
|-------------------------|------|
| Machine à café..... | 59 |
| Machine à pâtes..... | 35 |
| Manche pour balais..... | 87 |
| Mandoline..... | 26 |
| Manne à pain..... | 54 |
| Marmite..... | 7, 9 |
| Marqueur..... | 57 |
| Maryse..... | 33 |
| Mesure graduée..... | 41 |
| Mocassins..... | 108 |

| | |
|---------------------|-----------------|
| Monobrosse..... | 86 |
| Moule..... | 23, 24, 39 à 41 |
| Moulin broyeur..... | 27 |
| Mini Brasero..... | 15 |

N

| | |
|------------------------|------------|
| Nettoyant..... | 59, 60, 77 |
| Noyaux de cuisson..... | 39 |

O

| | |
|--|----|
| Ouvre-huîtres..... | 25 |
| Ouvre-boîtes..... | 28 |
| Organisateurs pour flacon verseur..... | 35 |

P

| | |
|--------------------------------------|------------------------|
| Palette de rechange/de stockage..... | 23, 58 |
| Panier à couverts..... | 81, 82 |
| Pantalon femme..... | 98 |
| Pantalon homme..... | 100 |
| Pantalon mixte..... | 105 à 107 |
| Papier cuisson..... | 45 |
| Papier paraffiné..... | 23 |
| Papier toilette..... | 78, 79 |
| Passe-bouillon..... | 34 |
| Passoire..... | 34 |
| Pasta box..... | 70 |
| Pâte à polir..... | 4 |
| Patière..... | 54 |
| Pèle-pomme..... | 29 |
| Pelle..... | 32, 33, 40, 44, 55, 87 |
| Pelle à frites..... | 32 |
| Pelle à mesurer..... | 55 |
| Pelle à omelette..... | 32 |
| Pelle à pizza..... | 44 |
| Pelle à steak..... | 32 |
| Pelle de cuisson..... | 32 |
| Pelle de service..... | 40 |
| Pelle spatule..... | 33 |
| Pèse sirop..... | 76 |
| Pierre à affûter..... | 22 |
| Pince à arêtes..... | 25 |
| Pince à brique..... | 60 |
| Pince à pâte..... | 38 |
| Pince pour plat..... | 48 |
| Pinceau..... | 37 |
| Piques brochette..... | 73 |
| Planche à découper..... | 27 |
| Plaque à baguettes..... | 39 |
| Plaque eutectique..... | 65 |
| Plaque madeleines..... | 40 |
| Plaque perforée..... | 45 |
| Plancha..... | 13 |
| Plaque ronde à pizza..... | 44 |
| Plat à paëlla..... | 13 |
| Plat à rôtir..... | 7 |
| Plateau repas isotherme..... | 65 |
| Poche pâtissière..... | 37, 38 |
| Pochette serviettes..... | 72 |
| Poêle..... | 5, 6, 8 à 14 |
| Poêle à omelette..... | 11 |
| Poêle à poisson..... | 12 |
| Porte balai mural..... | 87 |

P - Z

P

| | |
|--------------------------|--------|
| Porte casiers..... | 81 |
| Porte étiquettes..... | 53 |
| Porte-sac..... | 89 |
| Pots..... | 69 |
| Poubelle..... | 88, 89 |
| Produits lessiviels..... | 77 |

R

| | |
|-----------------------------|---------|
| Racleur professionnel..... | 15 |
| Rack égouttoir..... | 27 |
| Raclette sol..... | 87 |
| Râpe..... | 27 |
| Rasoir à truffes..... | 25 |
| Rasoir à légumes..... | 25 |
| Rayonnage..... | 53 |
| Recharge film/alu..... | 66 |
| Recharge pâtissière..... | 37 |
| Récipient..... | 69 à 71 |
| Réglette coupe-fil..... | 66 |
| Rouleau à pâte..... | 24, 36 |
| Rouleau de housse..... | 37 |
| Roulette de pâtisserie..... | 37 |
| Roulette à pizza..... | 44 |

S

| | |
|--------------------------|---------------|
| Sabot..... | 109 |
| Sac à linge..... | 91 |
| Sac cabas..... | 73 |
| Sac container..... | 89 |
| Sac kraft..... | 73 |
| Sac poubelle..... | 89 |
| Sac pour aspirateur..... | 86 |
| Sac sous vide..... | 66 |
| Sac de conservation..... | 66 |
| Saupoudreuse..... | 43 |
| Sauteuse..... | 4, 5, 6, 8, 9 |
| Sautoir..... | 4, 5, 7 |
| Saladiers..... | 71 |
| Scie de boucher..... | 23 |
| Seau à bec..... | 54 |
| Seau inox..... | 54 |
| Sèche-mains..... | 78, 79 |
| Sectionneur melon..... | 29 |
| Serviettes..... | 73 |
| Shopping box..... | 65 |

| | |
|-------------------------|------------|
| Siphon..... | 43 |
| Socle mobile..... | 64 |
| Socle rouleur..... | 58, 64, 81 |
| Spatule..... | 32, 33 |
| Spray de démoulage..... | 39 |
| Support poubelle..... | 61, 91 |
| Support sac..... | 88 à 91 |

T

| | |
|---------------------------|--------|
| Tamis..... | 43 |
| Tablier..... | 23, 93 |
| Tapis anti-dérapant..... | 87 |
| Tartelette..... | 40 |
| Tartineur à sandwich..... | 24 |
| Testeur d'huile..... | 75 |
| Thermomètre..... | 76 |
| Timon universel..... | 58 |
| Toile de cuisson..... | 46 |
| Torchon..... | 92 |
| Tourtière..... | 40 |
| Trépied pour brûleur..... | 15 |
| Trousse à couteaux..... | 16, 23 |

U

| | |
|-------------------|---------|
| Usage unique..... | 68 à 75 |
|-------------------|---------|

V

| | |
|-------------------|-----------|
| Verseuse..... | 59 |
| Veste femme..... | 94 à 97 |
| Veste homme..... | 99 |
| Veste mixte..... | 101 à 104 |
| Vide marmite..... | 31 |
| Vide-pommes..... | 24 |

W

| | |
|----------|----------|
| Wok..... | 5, 6, 11 |
|----------|----------|

Z

| | |
|--------------|----|
| Zesteur..... | 24 |
|--------------|----|

A - O

A

| | |
|-------------------------------------|--|
| Ardoise..... | 95, 96 |
| Assiette à pizza..... | 129 |
| Assiette collectivité..... | 131 à 135, 143 à 151 |
| Assiette en grès..... | 110 à 112, 114, 125 |
| Assiette copolyester, mélamine..... | 135, 144, 149 |
| Assiette polypropylène..... | 148 |
| Assiette haute température..... | 145 |
| Assiette en porcelaine..... | 112 |
| Assiette porcelaine..... | 110 à 116, 123, 124, 127, 129, 131 à 134 |

B

| | |
|----------------------------|---|
| Bac à glaçons..... | 202 |
| Base en liège..... | 140 |
| Bidon de chauffe..... | 208 |
| Boite gel de chauffe..... | 208 |
| Boîte pour présentoir..... | 211 |
| Bol à oreilles..... | 148, 149 |
| Bol grès..... | 110, 112, 125 |
| Bol collectivité..... | 131 à 135, 143, 146 à 149 |
| Bol copolyester..... | 149 |
| Bol mélamine..... | 135 |
| Bol polypropylène..... | 148 |
| Bol porcelaine..... | 110, 115, 116, 123, 124, 129, 131, 132, 134 |
| Bouchon à champagne..... | 20 |
| Bouchon hermétique..... | 200 0 |
| Buffet..... | 206 à 21 |
| Bloc commande..... | 192 |

C

| | |
|------------------------------------|--|
| Cafetière..... | 141 |
| Cagettes en carton..... | 215 |
| Calotte..... | 114, 115, 130 |
| Carafe..... | 151, 176 à 177 |
| Cassolette..... | 173 |
| Cendriers..... | 192 |
| Chafing dish..... | 208 |
| Chariot buffet..... | 209 |
| Chaussures..... | 226 |
| Chevalet..... | 192 |
| Chemise..... | 224 |
| Ceinturetablier..... | 225 |
| Chope..... | 163, 166 à 169 |
| Cloche..... | 144, 145 |
| Cloche de protection..... | 144 |
| Cocotte..... | 187 |
| Comptoir..... | 131, 136, 146, 147 |
| Conservateur à glaçons..... | 204 |
| Corbeille à agrumes, à fruits..... | 182 |
| Corbeille à pain..... | 178 à 182 |
| Coupe à glace..... | 174, 175 |
| Coupelle..... | 114, 114, 115, 123 à 127, 131 à 133, 137 |
| Couteau à steak..... | 158, 159 |
| Couverts..... | 152 à 159 |
| Couvert adaptable..... | 144 |
| Cuillère à dégustation..... | 139 |
| Consigne de sécurité..... | 197 |
| Crémier..... | 141, 142 |
| Cuillère de service..... | 51, 53 à 55, 104 |

| | |
|--------------------------------------|-----|
| Cuiseur à oeufs..... | 210 |
| Curette..... | 186 |
| Couteau fourchette avec planche..... | 139 |

D

| | |
|------------------------------|-----|
| Dentelle..... | 215 |
| Distributeur à céréales..... | 210 |
| Distributeur à jus..... | 210 |
| Distributeur de sauces..... | 207 |
| Doseur..... | 200 |

E

| | |
|---------------------------|-----|
| Étiquette allergènes..... | 197 |
|---------------------------|-----|

F

| | |
|-----------------------------|-----------|
| Feutre..... | 194 |
| Feutre-craie..... | 194 |
| Flûte à champagne..... | 160 à 163 |
| Fontes..... | 138 |
| Fourchette à escargots..... | 185 |
| Fourchette à huître..... | 186 |
| Flûte à céréales..... | 210 |

G

| | |
|----------------------------|------------------------------------|
| Gilet..... | 222 |
| Gobelet..... | 123, 142, 143 |
| Gobelet copolyester..... | 148, 149, 160, 161, 163, 166 à 169 |
| Gobelet polypropylène..... | 148 |

I

| | |
|-------------------|------|
| Intercalaire..... | 195 |
| Irich coffee..... | 1421 |

L

| | |
|------------------------|----------|
| Légumier inox..... | 185 |
| Liteau..... | 225 |
| Louche de service..... | 202, 206 |
| Louche à punch..... | 202 |

M

| | |
|----------------------|-------------------------------|
| Mélamine..... | 135 |
| Ménagère..... | 184 |
| Mortier..... | 201 |
| Moulin à épices..... | 184 |
| Mug..... | 110 à 112, 114, 115, 133, 147 |

N

| | |
|------------|----------|
| Nappe..... | 218, 219 |
|------------|----------|

O

| | |
|---------------------|-----|
| Origine viande..... | 195 |
|---------------------|-----|

P - V

P

| | |
|--------------------------------|-------------------------------|
| Paille | 202 |
| Panière | 178 à 181 |
| Panneau licence | 197 |
| Panneau consommation | 197 |
| Pantalon | 222, 223 |
| Passoire à cocktail | 201 |
| Pelle à tarte/ à gâteau | 154, 206 |
| Pelle de service | 140 |
| Pichet | 126, 150, 151, 176 à 177, 210 |
| Pichet inox | 151 |
| Pichet copolyesther | 151 |
| Pichet polypropylène | 151 |
| Pichet isotherme | 150 |
| Pilon | 201 |
| Pince à charcuterie | 206 |
| Pince à escargots | 185 |
| Pince à glaçons | 201 |
| Pince à homards | 186 |
| Pince de service | 206 |
| Pince multi-usage | 206 |
| Plaque chauffante | 209 |
| Plaque triangulaire | 140 |
| Planche à découper | 213 |
| Planche menu | 195 |
| Planche à pain | 213 |
| Plat à poisson | 185 |
| Plat à escargot | 185 |
| Plat à gratin inox | 185 |
| Plat de présentation | 212 |
| Plat à tarte / cke | 211 |
| Plateau en carton | 215 |
| Plateau enfant | 143 |
| Plateau de fruits de mer | 186 |
| Plateau gastronomique | 147 |
| Plateau forme goutte | 142 |
| Plateau à poignée | 140 |
| Plateau de présentation | 140 |
| Plateau de service | 188 à 191 |
| Plateau à tacos | 140 |
| Plateau traiteur | 215 |
| Plateau à sandwiches | 140 |
| Pochette serviettes | 218 |
| Pompe à condiments | 200, 207 |
| Pomp à vide d'air | 200 |
| Porte-Affiche | 192 |
| Porte-menu | 195, 196 |
| Porte-parapluies | 192 |
| Pot à lait | 141, 142 |
| Poke bowl | 117 |
| Présentoir | 211 |

R

| | |
|-------------------------|------------------------------|
| Rack à verres | 202 |
| Ramasse-miettes | 202 |
| Ramequin | 136, 142, 146, 147 |
| Ravier | 131, 133, 136, 143, 147, 149 |
| Règlement chambre | 197 |
| Rouleau nappe | 218, 219 |

S

| | |
|----------------------------|---|
| Saladier | 110, 114, 115, 118, 120, 131, 133, 134, 136, 137, 212 |
| Salière-poivrière | 183 à 184 |
| Saupoudreuse | 184 |
| Seau pour addition | 192 |
| Seau à champagne | 204, 205 |
| Seau à glace | 204 |
| Seau à glaçons | 204 |
| Seau à frites | 130 |
| Serre jambon | 213 |
| Serviette | 78, 113 à 115, 218, 219 |
| Set de table | 113, 115, 116 |
| Shaker | 201 |
| Sonnette de comptoir | 192 |
| Sucrier | 114 |
| Support bouteille | 204 |
| Support plateau | 186 |
| Support seau | 205 |

T

| | |
|--------------------|--|
| Tablier | 225 |
| Tartineur | 154 |
| Tasses | 110, 111, 113 à 115, 118, 119, 122 à 125, 131 à 133, 141 à 143, 146, 147 |
| Tasses à bec | 143 |
| Traiteurs | 215 à 217 |
| Textile | 220 à 226 |
| Théière | 114, 122, 131, 141 |
| Tire-bouchon | 200 |

U

| | |
|----------------------------|-----------|
| Usage unique | 215 à 219 |
| Ustensiles de buffet | 206 |

V

| | |
|----------------------------|----------------|
| Verres à bière | 171 |
| Verres à cocktail | 170 |
| Verres à pied | 160 à 163, 214 |
| Verres jaugés | 164 |
| Verrines | 172, 173, 214 |
| Veste | 118 |
| Verseuse à pompe | 210 |
| Verres personnalisés | 165 |

| Code GIF | Pages | Code GIF | Pages | Code GIF | Pages | Code GIF | Pages | Code GIF | Pages |
|----------|-------|----------|-------|----------|-------|----------|-------|----------|-------|
| 100029 | 201 | 100322 | 131 | 100741 | 118 | 101108 | 177 | 101583 | 151 |
| 100035 | 120 | 100323 | 131 | 100742 | 118 | 101134 | 141 | 101584 | 151 |
| 100036 | 120 | 100324 | 131 | 100743 | 118 | 101144 | 120 | 101585 | 151 |
| 100049 | 201 | 100330 | 130 | 100744 | 118 | 101145 | 120 | 101586 | 150 |
| 100051 | 203 | 100339 | 130 | 100745 | 118 | 101158 | 120 | 101587 | 150 |
| 100052 | 201 | 100417 | 118 | 100746 | 118 | 101159 | 162 | 101588 | 150 |
| 100057 | 201 | 100422 | 118 | 100747 | 118 | 101210 | 163 | 101590 | 150 |
| 100058 | 153 | 100423 | 118 | 100748 | 118 | 101213 | 163 | 101591 | 150 |
| 100059 | 153 | 100425 | 172 | 100749 | 118 | 101214 | 163 | 101592 | 150 |
| 100060 | 153 | 100428 | 118 | 100750 | 118 | 101217 | 163 | 101594 | 150 |
| 100061 | 153 | 100429 | 118 | 100751 | 118 | 101219 | 163 | 101595 | 150 |
| 100062 | 153 | 100430 | 118 | 100752 | 118 | 101224 | 163 | 101596 | 150 |
| 100063 | 153 | 100443 | 118 | 100753 | 118 | 101225 | 177 | 101600 | 176 |
| 100064 | 153 | 100444 | 118 | 100754 | 118 | 101246 | 177 | 101674 | 151 |
| 100065 | 153 | 100445 | 118 | 100755 | 118 | 101287 | 121 | 101675 | 151 |
| 100066 | 153 | 100446 | 118 | 100756 | 118 | 101293 | 121 | 101676 | 151 |
| 100087 | 175 | 100447 | 118 | 100777 | 137 | 101329 | 174 | 101677 | 151 |
| 100104 | 164 | 100448 | 118 | 100778 | 137 | 101336 | 131 | 101678 | 151 |
| 100105 | 162 | 100449 | 118 | 100779 | 137 | 101346 | 134 | 101679 | 151 |
| 100117 | 161 | 100450 | 118 | 100780 | 137 | 101347 | 134 | 101680 | 151 |
| 100118 | 161 | 100451 | 118 | 100781 | 137 | 101348 | 133 | 101681 | 151 |
| 100119 | 175 | 100452 | 118 | 100787 | 118 | 101349 | 133 | 101682 | 151 |
| 100121 | 175 | 100453 | 118 | 100788 | 118 | 101383 | 160 | 101683 | 151 |
| 100154 | 131 | 100454 | 118 | 100789 | 118 | 101384 | 160 | 101684 | 151 |
| 100157 | 130 | 100455 | 118 | 100790 | 118 | 101385 | 160 | 101685 | 151 |
| 100158 | 130 | 100456 | 118 | 100791 | 118 | 101386 | 160 | 101686 | 151 |
| 100159 | 130 | 100457 | 118 | 100792 | 118 | 101387 | 160 | 101687 | 151 |
| 100160 | 110 | 100458 | 118 | 100793 | 118 | 101400 | 212 | 101688 | 151 |
| 100161 | 110 | 100459 | 118 | 100794 | 118 | 101407 | 212 | 101689 | 151 |
| 100162 | 110 | 100460 | 118 | 100795 | 118 | 101408 | 130 | 101690 | 151 |
| 100163 | 110 | 100461 | 118 | 100796 | 118 | 101409 | 130 | 101691 | 151 |
| 100165 | 111 | 100501 | 118 | 100797 | 118 | 101410 | 130 | 101692 | 151 |
| 100173 | 111 | 100502 | 118 | 100798 | 118 | 101411 | 130 | 101693 | 151 |
| 100174 | 111 | 100503 | 118 | 100799 | 118 | 101417 | 168 | 101694 | 151 |
| 100176 | 111 | 100504 | 118 | 100804 | 119 | 101428 | 130 | 101699 | 176 |
| 100177 | 111 | 100505 | 118 | 100805 | 119 | 101456 | 142 | 101774 | 159 |
| 100184 | 110 | 100506 | 118 | 100806 | 119 | 101475 | 137 | 101776 | 158 |
| 100185 | 110 | 100507 | 118 | 100807 | 119 | 101476 | 137 | 101901 | 116 |
| 100186 | 110 | 100517 | 141 | 100808 | 119 | 101477 | 137 | 101902 | 116 |
| 100191 | 110 | 100562 | 118 | 100808 | 119 | 101478 | 137 | 101903 | 116 |
| 100192 | 110 | 100563 | 118 | 100809 | 119 | 101479 | 137 | 101904 | 116 |
| 100193 | 110 | 100564 | 118 | 100810 | 119 | 101480 | 137 | 101905 | 116 |
| 100194 | 110 | 100565 | 118 | 100812 | 119 | 101481 | 137 | 101906 | 116 |
| 100195 | 110 | 100566 | 118 | 100813 | 119 | 101481 | 137 | 101907 | 116 |
| 100196 | 110 | 100566 | 118 | 100814 | 119 | 101519 | 161 | 101908 | 116 |
| 100197 | 110 | 100567 | 118 | 100814 | 119 | 101520 | 161 | 101909 | 116 |
| 100198 | 110 | 100568 | 118 | 100815 | 119 | 101525 | 176 | 101910 | 116 |
| 100199 | 110 | 100568 | 118 | 100816 | 119 | 101550 | 176 | 101911 | 116 |
| 100200 | 110 | 100569 | 118 | 100822 | 137 | 101552 | 148 | 101912 | 116 |
| 100201 | 110 | 100572 | 118 | 100823 | 137 | 101554 | 148 | 101913 | 116 |
| 100202 | 110 | 100573 | 118 | 100826 | 118 | 101555 | 148 | 101914 | 116 |
| 100203 | 110 | 100574 | 118 | 100833 | 168 | 101556 | 148 | 101915 | 116 |
| 100204 | 110 | 100575 | 118 | 100834 | 168 | 101561 | 148 | 101916 | 116 |
| 100205 | 110 | 100576 | 118 | 100864 | 43 | 101562 | 148 | 101917 | 116 |
| 100206 | 110 | 100576 | 118 | 100865 | 43 | 101563 | 148 | 101918 | 116 |
| 100207 | 110 | 100640 | 171 | 100866 | 43 | 101565 | 148 | 101919 | 116 |
| 100208 | 110 | 100641 | 171 | 100870 | 73 | 101566 | 144 | 101920 | 116 |
| 100211 | 110 | 100711 | 205 | 100900 | 168 | 101567 | 144 | 101940 | 130 |
| 100212 | 110 | 100713 | 205 | 100901 | 168 | 101568 | 144 | 101941 | 130 |
| 100213 | 110 | 100715 | 204 | 100910 | 166 | 101569 | 151 | 101942 | 130 |
| 100214 | 110 | 100724 | 118 | 100911 | 166 | 101570 | 151 | 101943 | 130 |
| 100216 | 110 | 100725 | 118 | 101000 | 176 | 101571 | 151 | 101944 | 130 |
| 100217 | 110 | 100726 | 118 | 101005 | 176 | 101572 | 151 | 101945 | 130 |
| 100218 | 110 | 100728 | 118 | 101006 | 176 | 101573 | 151 | 101948 | 130 |
| 100219 | 110 | 100729 | 118 | 101007 | 177 | 101574 | 151 | 101949 | 130 |
| 100244 | 176 | 100730 | 118 | 101008 | 177 | 101575 | 151 | 101950 | 130 |
| 100245 | 176 | 100731 | 118 | 101009 | 141 | 101576 | 151 | 101966 | 145 |
| 100246 | 176 | 100732 | 118 | 101010 | 177 | 101577 | 151 | 101967 | 145 |
| 100313 | 131 | 100733 | 118 | 101011 | 169 | 101578 | 151 | 101968 | 145 |
| 100315 | 131 | 100734 | 118 | 101015 | 169 | 101579 | 151 | 101969 | 145 |
| 100319 | 131 | 100735 | 118 | 101018 | 169 | 101580 | 151 | 101970 | 145 |
| | | 100736 | 118 | 101019 | 162 | 101581 | 151 | 101971 | 145 |
| | | 100738 | 118 | 101020 | 169 | 101582 | 151 | | |
| | | 100739 | 118 | 101038 | 169 | | | | |
| | | 100740 | 118 | | | | | | |

| Code GIF | Pages | Code GIF | Pages | Code GIF | Pages | Code GIF | Pages | Code GIF | Pages |
|----------|-------|----------|-------|----------|-------|----------|-------|----------|-------|
| 101972 | 145 | 102546 | 192 | 102857 | 147 | 103032 | 210 | 103116 | 220 |
| 101973 | 145 | 102547 | 199 | 102858 | 147 | 103033 | 210 | 103117 | 220 |
| 101986 | 150 | 102548 | 198 | 102859 | 147 | 103034 | 210 | 103118 | 220 |
| 101987 | 150 | 102549 | 198 | 102860 | 147 | 103035 | 210 | 103119 | 220 |
| 101988 | 150 | 102550 | 198 | 102861 | 147 | 103036 | 210 | 103120 | 220 |
| 101989 | 150 | 102551 | 193 | 102862 | 147 | 103037 | 209 | 103121 | 220 |
| 101990 | 150 | 102552 | 193 | 102863 | 147 | 103039 | 209 | 103122 | 220 |
| 101991 | 150 | 102565 | 206 | 102864 | 147 | 103040 | 209 | 103123 | 220 |
| 101992 | 150 | 102566 | 208 | 102865 | 147 | 103041 | 209 | 103124 | 220 |
| 101993 | 150 | 102573 | 212 | 102866 | 147 | 103042 | 208 | 103125 | 220 |
| 101994 | 150 | 102574 | 212 | 102867 | 147 | 103043 | 208 | 103126 | 220 |
| 101995 | 150 | 102575 | 212 | 102868 | 147 | 103044 | 211 | 103127 | 220 |
| 101996 | 150 | 102576 | 212 | 102869 | 147 | 103045 | 211 | 103128 | 225 |
| 101997 | 150 | 102577 | 212 | 102870 | 147 | 103046 | 211 | 103129 | 225 |
| 102001 | 157 | 102578 | 212 | 102871 | 147 | 103047 | 212 | 103131 | 225 |
| 102002 | 157 | 102582 | 182 | 102872 | 147 | 103048 | 212 | 103132 | 225 |
| 102003 | 157 | 102583 | 182 | 102873 | 147 | 103049 | 212 | 103133 | 225 |
| 102004 | 157 | 102584 | 182 | 102874 | 147 | 103050 | 212 | 103134 | 225 |
| 102005 | 206 | 102611 | 72 | 102875 | 147 | 103051 | 212 | 103135 | 225 |
| 102006 | 206 | 102613 | 73 | 102876 | 147 | 103052 | 212 | 103136 | 225 |
| 102025 | 206 | 102614 | 73 | 102877 | 147 | 103053 | 214 | 103137 | 225 |
| 102026 | 206 | 102615 | 72 | 102878 | 147 | 103054 | 214 | 103138 | 225 |
| 102033 | 157 | 102616 | 72 | 102879 | 147 | 103055 | 214 | 103139 | 225 |
| 102034 | 157 | 102617 | 73 | 102880 | 147 | 103056 | 214 | 103140 | 225 |
| 102036 | 157 | 102618 | 73 | 102881 | 147 | 103057 | 214 | 103141 | 225 |
| 102038 | 202 | 102619 | 73 | 102882 | 147 | 103058 | 214 | 103142 | 225 |
| 102075 | 180 | 102620 | 73 | 102883 | 147 | 103059 | 214 | 103143 | 225 |
| 102077 | 180 | 102621 | 73 | 102884 | 147 | 103060 | 214 | 103351 | 168 |
| 102078 | 180 | 102623 | 73 | 102885 | 147 | 103061 | 214 | 103354 | 168 |
| 102085 | 128 | 102624 | 73 | 102886 | 147 | 103062 | 214 | 103356 | 170 |
| 102086 | 128 | 102628 | 72 | 102887 | 147 | 103063 | 215 | 103357 | 170 |
| 102087 | 127 | 102629 | 72 | 102888 | 147 | 103070 | 215 | 103358 | 170 |
| 102088 | 127 | 102630 | 72 | 102889 | 147 | 103071 | 215 | 103359 | 170 |
| 102089 | 127 | 102631 | 72 | 102890 | 150 | 103072 | 215 | 103360 | 170 |
| 102091 | 134 | 102632 | 72 | 102891 | 150 | 103073 | 215 | 103361 | 170 |
| 102092 | 134 | 102807 | 223 | 102892 | 150 | 103074 | 215 | 103362 | 170 |
| 102093 | 134 | 102808 | 223 | 102943 | 210 | 103075 | 215 | 103363 | 170 |
| 102094 | 134 | 102809 | 223 | 102944 | 210 | 103076 | 215 | 103364 | 170 |
| 102095 | 134 | 102810 | 223 | 102961 | 143 | 103077 | 215 | 103365 | 170 |
| 102096 | 134 | 102811 | 223 | 102962 | 143 | 103079 | 218 | 103366 | 173 |
| 102097 | 134 | 102812 | 223 | 102963 | 143 | 103081 | 218 | 103383 | 170 |
| 102098 | 134 | 102813 | 223 | 102964 | 143 | 103082 | 218 | 103386 | 170 |
| 102119 | 159 | 102814 | 223 | 102991 | 162 | 103084 | 218 | 103413 | 132 |
| 102121 | 142 | 102815 | 223 | 102992 | 162 | 103085 | 218 | 103414 | 132 |
| 102122 | 142 | 102816 | 223 | 102993 | 162 | 103088 | 218 | 103416 | 132 |
| 102123 | 142 | 102817 | 223 | 102995 | 193 | 103089 | 219 | 103417 | 132 |
| 102124 | 142 | 102818 | 223 | 102996 | 192 | 103090 | 219 | 103418 | 132 |
| 102127 | 187 | 102819 | 223 | 102997 | 193 | 103091 | 219 | 103419 | 132 |
| 102128 | 187 | 102820 | 223 | 102998 | 193 | 103092 | 219 | 103420 | 122 |
| 102209 | 159 | 102821 | 223 | 103001 | 199 | 103093 | 219 | 103421 | 122 |
| 102222 | 159 | 102822 | 223 | 103002 | 199 | 103094 | 219 | 103457 | 113 |
| 102277 | 174 | 102823 | 223 | 103003 | 193 | 103095 | 219 | 103458 | 113 |
| 102278 | 174 | 102824 | 223 | 103004 | 193 | 103096 | 219 | 103459 | 113 |
| 102286 | 175 | 102825 | 223 | 103005 | 193 | 103097 | 219 | 103460 | 113 |
| 102289 | 174 | 102826 | 223 | 103007 | 195 | 103098 | 219 | 103461 | 113 |
| 102416 | 171 | 102827 | 223 | 103008 | 198 | 103099 | 219 | 103462 | 113 |
| 102422 | 171 | 102828 | 223 | 103011 | 199 | 103100 | 219 | 103463 | 113 |
| 102454 | 130 | 102829 | 223 | 103013 | 199 | 103101 | 219 | 103464 | 113 |
| 102456 | 130 | 102830 | 223 | 103015 | 200 | 103102 | 219 | 103465 | 113 |
| 102508 | 159 | 102831 | 223 | 103016 | 200 | 103103 | 219 | 103466 | 113 |
| 102510 | 158 | 102832 | 223 | 103017 | 200 | 103104 | 220 | 103467 | 113 |
| 102511 | 158 | 102833 | 223 | 103018 | 200 | 103105 | 220 | 103468 | 113 |
| 102519 | 186 | 102834 | 223 | 103020 | 203 | 103106 | 220 | 103469 | 112 |
| 102520 | 207 | 102848 | 147 | 103021 | 203 | 103107 | 220 | 103470 | 112 |
| 102521 | 207 | 102849 | 147 | 103022 | 202 | 103108 | 220 | 103471 | 112 |
| 102522 | 207 | 102850 | 147 | 103023 | 206 | 103109 | 220 | 103604 | 120 |
| 102523 | 207 | 102851 | 147 | 103024 | 206 | 103110 | 220 | 103605 | 120 |
| 102524 | 207 | 102852 | 147 | 103025 | 206 | 103111 | 220 | 103606 | 120 |
| 102526 | 196 | 102853 | 147 | 103026 | 206 | 103112 | 220 | 103607 | 121 |
| 102529 | 195 | 102854 | 147 | 103027 | 206 | 103113 | 220 | 103608 | 122 |
| 102535 | 192 | 102855 | 147 | 103030 | 206 | 103114 | 220 | 103632 | 128 |
| 102544 | 192 | 102856 | 147 | 103031 | 206 | 103115 | 220 | 103633 | 128 |

INDEX

par référence

| Code GIF | Pages | Code GIF | Pages | Code GIF | Pages | Code GIF | Pages | Code GIF | Pages |
|----------|-------|----------|-------|----------|-------|----------|-------|----------|-------|
| 103634 | 128 | 106106 | 131 | 108382 | 149 | 110623 | 133 | 112767 | 206 |
| 103635 | 127 | 106107 | 131 | 108389 | 149 | 110815 | 133 | 112772 | 151 |
| 103636 | 127 | 106109 | 131 | 108390 | 149 | 110820 | 133 | 112773 | 151 |
| 103637 | 127 | 106112 | 131 | 108391 | 149 | 110821 | 133 | 112774 | 151 |
| 103638 | 127 | 106120 | 131 | 108392 | 149 | 110823 | 133 | 112776 | 151 |
| 103639 | 127 | 106148 | 136 | 109000 | 200 | 110900 | 133 | 112777 | 151 |
| 103640 | 127 | 106205 | 131 | 109024 | 185 | 110901 | 133 | 112778 | 151 |
| 103641 | 127 | 106206 | 131 | 109030 | 185 | 110902 | 133 | 112779 | 151 |
| 103642 | 132 | 107132 | 163 | 109037 | 185 | 110903 | 133 | 112780 | 151 |
| 103643 | 132 | 107133 | 163 | 109038 | 185 | 110904 | 133 | 112806 | 149 |
| 103644 | 132 | 107134 | 163 | 109051 | 204 | 110905 | 133 | 112807 | 149 |
| 103645 | 132 | 107135 | 163 | 109052 | 205 | 110906 | 133 | 112808 | 149 |
| 103646 | 132 | 107136 | 163 | 109071 | 182 | 110907 | 133 | 112809 | 149 |
| 103689 | 152 | 107137 | 167 | 109072 | 182 | 110908 | 133 | 112810 | 149 |
| 103690 | 152 | 107145 | 163 | 109083 | 186 | 110909 | 133 | 112811 | 149 |
| 103691 | 152 | 107167 | 164 | 109099 | 208 | 110910 | 133 | 112812 | 149 |
| 103692 | 152 | 107169 | 164 | 109101 | 141 | 110911 | 133 | 112813 | 149 |
| 103693 | 152 | 107198 | 166 | 109102 | 141 | 110913 | 133 | 112993 | 168 |
| 103694 | 152 | 107201 | 167 | 109105 | 141 | 110914 | 133 | 113153 | 205 |
| 103695 | 152 | 107202 | 167 | 109107 | 192 | 110915 | 133 | 113158 | 170 |
| 103696 | 152 | 107813 | 132 | 109111 | 141 | 110916 | 133 | 113171 | 210 |
| 103712 | 153 | 107815 | 132 | 109112 | 141 | 110917 | 133 | 113202 | 148 |
| 103713 | 153 | 107819 | 132 | 109122 | 185 | 110918 | 133 | 113203 | 148 |
| 103714 | 153 | 107822 | 132 | 109123 | 206 | 110919 | 133 | 113204 | 148 |
| 103715 | 153 | 107823 | 132 | 109124 | 185 | 110922 | 133 | 113205 | 148 |
| 103716 | 153 | 107919 | 134 | 109125 | 27 | 110923 | 133 | 113206 | 148 |
| 103717 | 153 | 107921 | 134 | 109131 | 206 | 110924 | 133 | 113207 | 148 |
| 103718 | 153 | 107923 | 134 | 109152 | 184 | 110925 | 133 | 113208 | 148 |
| 103719 | 153 | 107954 | 101 | 109154 | 184 | 110926 | 133 | 113209 | 148 |
| 103720 | 153 | 107955 | 101 | 109164 | 206 | 110927 | 133 | 113210 | 148 |
| 103721 | 153 | 107956 | 101 | 109175 | 185 | 111015 | 169 | 113211 | 148 |
| 103723 | 153 | 107957 | 101 | 109176 | 185 | 111116 | 169 | 113212 | 148 |
| 103724 | 153 | 107958 | 101 | 109201 | 185 | 111121 | 169 | 113213 | 148 |
| 103725 | 153 | 107959 | 101 | 109202 | 185 | 111870 | 131 | 113259 | 200 |
| 103726 | 153 | 107960 | 101 | 109203 | 185 | 111871 | 131 | 113266 | 204 |
| 103727 | 153 | 107961 | 97 | 109204 | 185 | 111875 | 130 | 113347 | 145 |
| 103728 | 153 | 107962 | 97 | 109205 | 185 | 111876 | 130 | 113348 | 145 |
| 103729 | 153 | 107963 | 97 | 109206 | 185 | 111877 | 130 | 113349 | 145 |
| 103730 | 153 | 107964 | 97 | 109210 | 151 | 111994 | 133 | 113350 | 145 |
| 103731 | 153 | 107965 | 97 | 109211 | 151 | 111995 | 133 | 113351 | 145 |
| 103732 | 153 | 107966 | 97 | 109212 | 151 | 111996 | 133 | 113352 | 145 |
| 103733 | 153 | 107967 | 97 | 109213 | 185 | 111997 | 133 | 113353 | 145 |
| 103734 | 153 | 107978 | 167 | 109215 | 185 | 112196 | 167 | 113354 | 145 |
| 103743 | 147 | 107979 | 167 | 109217 | 185 | 112197 | 167 | 113355 | 145 |
| 103744 | 147 | 107980 | 167 | 109220 | 185 | 112221 | 200 | 113356 | 145 |
| 103745 | 147 | 107981 | 167 | 109222 | 185 | 112247 | 171 | 113394 | 164 |
| 103746 | 147 | 107983 | 97 | 109230 | 185 | 112248 | 171 | 113395 | 164 |
| 103747 | 147 | 107984 | 97 | 109246 | 202 | 112261 | 168 | 113396 | 164 |
| 103748 | 147 | 107985 | 97 | 109339 | 202 | 112264 | 168 | 113400 | 172 |
| 103749 | 147 | 107986 | 97 | 109347 | 192 | 112265 | 168 | 113412 | 202 |
| 103750 | 147 | 107987 | 97 | 109433 | 206 | 112276 | 174 | 113733 | 133 |
| 103751 | 172 | 107988 | 97 | 109434 | 206 | 112559 | 206 | 113734 | 133 |
| 103752 | 173 | 107989 | 101 | 109509 | 131 | 112562 | 206 | 113735 | 133 |
| 103753 | 173 | 107990 | 101 | 109513 | 131 | 112563 | 206 | 113736 | 133 |
| 103754 | 172 | 107991 | 101 | 109515 | 131 | 112566 | 206 | 113737 | 133 |
| 103755 | 172 | 107992 | 101 | 109519 | 131 | 112567 | 206 | 113738 | 133 |
| 103756 | 172 | 107993 | 101 | 109520 | 131 | 112568 | 206 | 113739 | 133 |
| 105001 | 210 | 107994 | 101 | 109523 | 131 | 112569 | 206 | 113740 | 133 |
| 105002 | 210 | 107995 | 101 | 109525 | 131 | 112570 | 206 | 113741 | 133 |
| 105004 | 210 | 107996 | 218 | 109528 | 131 | 112571 | 206 | 113742 | 133 |
| 106083 | 137 | 108025 | 151 | 109530 | 131 | 112572 | 206 | 113743 | 133 |
| 106084 | 137 | 108050 | 151 | 109561 | 137 | 112573 | 206 | 113744 | 133 |
| 106085 | 137 | 108062 | 150 | 109633 | 225 | 112574 | 206 | 113745 | 133 |
| 106086 | 137 | 108063 | 150 | 110512 | 133 | 112575 | 206 | 113746 | 133 |
| 106087 | 137 | 108066 | 150 | 110515 | 133 | 112585 | 141 | 113747 | 133 |
| 106088 | 137 | 108067 | 150 | 110519 | 133 | 112586 | 141 | 113748 | 133 |
| 106089 | 137 | 108100 | 151 | 110522 | 133 | 112639 | 186 | 113749 | 133 |
| 106090 | 137 | 108125 | 215 | 110523 | 133 | 112641 | 186 | 113750 | 133 |
| 106091 | 136 | 108126 | 215 | 110612 | 133 | 112644 | 186 | 113751 | 133 |
| 106092 | 136 | 108150 | 151 | 110615 | 133 | 112747 | 210 | 113752 | 133 |
| 106095 | 136 | 108151 | 151 | 110619 | 133 | 112748 | 210 | 113753 | 133 |
| 106105 | 131 | 108381 | 149 | 110622 | 133 | 112749 | 210 | 113754 | 133 |

| Code GIF | Pages | Code GIF | Pages | Code GIF | Pages | Code GIF | Pages | Code GIF | Pages |
|----------|-------|----------|-------|----------|-------|----------|-------|----------|-------|
| 113759 | 145 | 114432 | 154 | 114744 | 126 | 114977 | 187 | 115153 | 116 |
| 113760 | 145 | 114433 | 154 | 114747 | 126 | 114978 | 187 | 115154 | 116 |
| 113761 | 145 | 114434 | 154 | 114748 | 126 | 114979 | 187 | 115155 | 116 |
| 113762 | 145 | 114435 | 154 | 114751 | 130 | 114980 | 187 | 115156 | 116 |
| 113763 | 131 | 114436 | 154 | 114752 | 130 | 114981 | 187 | 115157 | 116 |
| 113764 | 131 | 114437 | 154 | 114783 | 141 | 114982 | 187 | 115158 | 116 |
| 113765 | 131 | 114438 | 154 | 114784 | 141 | 114984 | 187 | 115159 | 116 |
| 113766 | 131 | 114439 | 154 | 114785 | 141 | 114985 | 192 | 115160 | 116 |
| 113767 | 131 | 114440 | 154 | 114786 | 141 | 114986 | 187 | 115161 | 116 |
| 113768 | 131 | 114441 | 154 | 114788 | 141 | 114987 | 204 | 115162 | 116 |
| 113769 | 131 | 114442 | 154 | 114789 | 141 | 114990 | 180 | 115163 | 116 |
| 113812 | 169 | 114443 | 154 | 114790 | 141 | 114991 | 180 | 115164 | 116 |
| 113813 | 169 | 114444 | 154 | 114791 | 141 | 114992 | 180 | 115165 | 116 |
| 113881 | 170 | 114445 | 154 | 114793 | 141 | 114993 | 180 | 115166 | 116 |
| 113971 | 157 | 114446 | 154 | 114796 | 141 | 114994 | 180 | 115167 | 116 |
| 113972 | 157 | 114447 | 154 | 114797 | 141 | 114995 | 180 | 115279 | 115 |
| 113973 | 157 | 114448 | 154 | 114800 | 144 | 114998 | 180 | 115280 | 115 |
| 113974 | 157 | 114449 | 154 | 114801 | 144 | 114999 | 180 | 115281 | 115 |
| 113975 | 157 | 114454 | 158 | 114807 | 154 | 115000 | 180 | 115282 | 115 |
| 113976 | 157 | 114455 | 158 | 114808 | 154 | 115001 | 180 | 115283 | 115 |
| 113977 | 157 | 114456 | 158 | 114809 | 154 | 115002 | 180 | 115284 | 115 |
| 113978 | 157 | 114457 | 158 | 114810 | 154 | 115003 | 180 | 115289 | 119 |
| 113979 | 157 | 114458 | 158 | 114814 | 159 | 115004 | 180 | 115290 | 119 |
| 113980 | 157 | 114459 | 158 | 114815 | 141 | 115005 | 180 | 115291 | 119 |
| 114003 | 204 | 114460 | 158 | 114818 | 141 | 115006 | 180 | 115292 | 119 |
| 114007 | 184 | 114476 | 171 | 114819 | 141 | 115007 | 180 | 115293 | 119 |
| 114008 | 184 | 114478 | 171 | 114820 | 141 | 115008 | 180 | 115294 | 119 |
| 114009 | 184 | 114479 | 174 | 114822 | 141 | 115009 | 180 | 115295 | 119 |
| 114047 | 203 | 114483 | 174 | 114823 | 141 | 115016 | 192 | 115296 | 119 |
| 114050 | 203 | 114487 | 175 | 114824 | 141 | 115017 | 200 | 115297 | 119 |
| 114051 | 205 | 114488 | 175 | 114825 | 141 | 115018 | 200 | 115298 | 119 |
| 114052 | 205 | 114491 | 175 | 114826 | 141 | 115019 | 200 | 115299 | 119 |
| 114059 | 210 | 114492 | 175 | 114827 | 159 | 115054 | 212 | 115300 | 119 |
| 114061 | 210 | 114495 | 174 | 114828 | 159 | 115055 | 212 | 115310 | 127 |
| 114135 | 158 | 114508 | 182 | 114829 | 159 | 115056 | 212 | 115311 | 127 |
| 114183 | 166 | 114509 | 182 | 114830 | 159 | 115057 | 212 | 115312 | 127 |
| 114184 | 166 | 114510 | 182 | 114831 | 158 | 115058 | 212 | 115313 | 127 |
| 114185 | 166 | 114511 | 182 | 114833 | 161 | 115059 | 212 | 115314 | 127 |
| 114186 | 166 | 114512 | 182 | 114834 | 161 | 115060 | 212 | 115315 | 127 |
| 114187 | 166 | 114513 | 182 | 114835 | 161 | 115063 | 130 | 115316 | 127 |
| 114188 | 166 | 114517 | 200 | 114836 | 161 | 115064 | 130 | 115317 | 127 |
| 114190 | 166 | 114518 | 200 | 114838 | 168 | 115102 | 223 | 115318 | 127 |
| 114191 | 166 | 114520 | 201 | 114839 | 168 | 115103 | 223 | 115319 | 127 |
| 114237 | 202 | 114529 | 154 | 114845 | 171 | 115104 | 223 | 115320 | 127 |
| 114238 | 192 | 114530 | 154 | 114881 | 155 | 115105 | 223 | 115321 | 127 |
| 114239 | 213 | 114531 | 154 | 114882 | 155 | 115106 | 223 | 115322 | 127 |
| 114280 | 132 | 114532 | 154 | 114883 | 155 | 115107 | 223 | 115332 | 140 |
| 114286 | 139 | 114533 | 154 | 114884 | 155 | 115108 | 223 | 115333 | 140 |
| 114293 | 208 | 114534 | 154 | 114885 | 155 | 115109 | 223 | 115334 | 140 |
| 114294 | 208 | 114543 | 193 | 114886 | 155 | 115110 | 223 | 115335 | 140 |
| 114337 | 177 | 114545 | 112 | 114887 | 155 | 115111 | 223 | 115336 | 140 |
| 114338 | 177 | 114546 | 112 | 114888 | 155 | 115112 | 223 | 115337 | 140 |
| 114339 | 177 | 114547 | 112 | 114889 | 155 | 115113 | 223 | 115338 | 140 |
| 114340 | 177 | 114551 | 112 | 114890 | 155 | 115114 | 223 | 115339 | 140 |
| 114410 | 115 | 114552 | 112 | 114891 | 155 | 115115 | 223 | 115340 | 140 |
| 114411 | 115 | 114553 | 112 | 114915 | 125 | 115116 | 223 | 115341 | 140 |
| 114412 | 115 | 114554 | 112 | 114916 | 125 | 115117 | 223 | 115342 | 140 |
| 114413 | 115 | 114556 | 112 | 114917 | 125 | 115118 | 223 | 115343 | 140 |
| 114414 | 115 | 114561 | 131 | 114918 | 125 | 115119 | 223 | 115344 | 140 |
| 114419 | 115 | 114565 | 131 | 114919 | 125 | 115120 | 223 | 115345 | 140 |
| 114420 | 115 | 114567 | 131 | 114920 | 125 | 115121 | 223 | 115346 | 140 |
| 114421 | 115 | 114590 | 110 | 114921 | 125 | 115122 | 223 | 115347 | 140 |
| 114422 | 115 | 114591 | 110 | 114922 | 125 | 115123 | 223 | 115348 | 140 |
| 114423 | 115 | 114593 | 117 | 114961 | 166 | 115124 | 223 | 115349 | 140 |
| 114424 | 115 | 114594 | 117 | 114963 | 166 | 115125 | 223 | 115350 | 140 |
| 114425 | 115 | 114595 | 117 | 114964 | 166 | 115126 | 223 | 115351 | 140 |
| 114426 | 115 | 114597 | 124 | 114965 | 166 | 115127 | 223 | 115352 | 140 |
| 114427 | 115 | 114601 | 126 | 114966 | 166 | 115148 | 116 | 115353 | 140 |
| 114428 | 115 | 114604 | 126 | 114967 | 166 | 115149 | 116 | 115354 | 140 |
| 114429 | 154 | 114605 | 126 | 114974 | 188 | 115150 | 116 | 115382 | 151 |
| 114430 | 154 | 114606 | 126 | 114975 | 186 | 115151 | 116 | 115383 | 151 |
| 114431 | 154 | 114607 | 126 | 114976 | 187 | 115152 | 116 | 115384 | 151 |

INDEX

par référence

| Code GIF | Pages | Code GIF | Pages | Code GIF | Pages | Code GIF | Pages | Code GIF | Pages |
|----------|-------|----------|-------|----------|-------|----------|-------|----------|-------|
| 115385 | 151 | 115545 | 181 | 115656 | 191 | 115729 | 123 | 115801 | 124 |
| 115386 | 151 | 115546 | 181 | 115657 | 191 | 115730 | 123 | 115802 | 124 |
| 115387 | 151 | 115548 | 181 | 115658 | 186 | 115731 | 123 | 115803 | 124 |
| 115388 | 151 | 115549 | 181 | 115659 | 186 | 115732 | 123 | 115804 | 124 |
| 115389 | 151 | 115550 | 181 | 115661 | 186 | 115733 | 123 | 115805 | 124 |
| 115390 | 151 | 115561 | 182 | 115662 | 111 | 115734 | 123 | 115806 | 124 |
| 115391 | 151 | 115562 | 182 | 115663 | 111 | 115735 | 123 | 115807 | 124 |
| 115392 | 151 | 115563 | 182 | 115664 | 111 | 115736 | 123 | 115808 | 124 |
| 115393 | 151 | 115564 | 182 | 115665 | 111 | 115737 | 123 | 115809 | 124 |
| 115394 | 151 | 115565 | 182 | 115666 | 111 | 115738 | 123 | 115810 | 124 |
| 115395 | 151 | 115566 | 183 | 115667 | 111 | 115739 | 123 | 115811 | 124 |
| 115396 | 151 | 115567 | 183 | 115668 | 111 | 115740 | 123 | 115812 | 124 |
| 115397 | 151 | 115568 | 183 | 115669 | 111 | 115741 | 123 | 115813 | 124 |
| 115407 | 154 | 115571 | 183 | 115670 | 111 | 115742 | 123 | 115814 | 124 |
| 115408 | 154 | 115572 | 183 | 115671 | 111 | 115743 | 123 | 115815 | 124 |
| 115409 | 154 | 115573 | 183 | 115672 | 111 | 115744 | 123 | 115816 | 124 |
| 115410 | 154 | 115576 | 183 | 115673 | 111 | 115745 | 123 | 115817 | 125 |
| 115436 | 158 | 115577 | 183 | 115674 | 111 | 115746 | 123 | 115818 | 125 |
| 115451 | 160 | 115578 | 183 | 115675 | 111 | 115747 | 123 | 115819 | 125 |
| 115452 | 160 | 115581 | 183 | 115676 | 111 | 115748 | 123 | 115820 | 125 |
| 115453 | 160 | 115582 | 183 | 115677 | 114 | 115749 | 123 | 115821 | 125 |
| 115454 | 160 | 115583 | 183 | 115678 | 114 | 115750 | 123 | 115822 | 125 |
| 115455 | 160 | 115584 | 183 | 115679 | 114 | 115751 | 123 | 115823 | 125 |
| 115456 | 163 | 115585 | 183 | 115680 | 114 | 115752 | 123 | 115824 | 125 |
| 115457 | 163 | 115586 | 183 | 115681 | 114 | 115753 | 123 | 115825 | 125 |
| 115458 | 163 | 115588 | 183 | 115682 | 114 | 115754 | 123 | 115826 | 125 |
| 115459 | 163 | 115589 | 183 | 115683 | 114 | 115755 | 123 | 115827 | 125 |
| 115460 | 163 | 115593 | 183 | 115684 | 114 | 115756 | 123 | 115828 | 125 |
| 115465 | 167 | 115594 | 183 | 115685 | 114 | 115757 | 123 | 115829 | 125 |
| 115466 | 164 | 115598 | 183 | 115686 | 114 | 115758 | 123 | 115830 | 125 |
| 115467 | 164 | 115599 | 183 | 115687 | 114 | 115759 | 123 | 115831 | 125 |
| 115475 | 168 | 115602 | 184 | 115688 | 114 | 115760 | 123 | 115832 | 125 |
| 115476 | 168 | 115603 | 188 | 115689 | 114 | 115761 | 123 | 115833 | 125 |
| 115477 | 168 | 115604 | 188 | 115690 | 114 | 115762 | 123 | 115834 | 125 |
| 115478 | 169 | 115605 | 189 | 115691 | 114 | 115763 | 123 | 115835 | 125 |
| 115479 | 169 | 115606 | 189 | 115692 | 114 | 115764 | 123 | 115836 | 125 |
| 115480 | 169 | 115607 | 189 | 115693 | 114 | 115765 | 123 | 115837 | 125 |
| 115485 | 170 | 115608 | 189 | 115694 | 114 | 115766 | 123 | 115838 | 125 |
| 115486 | 170 | 115609 | 189 | 115695 | 114 | 115767 | 124 | 115839 | 125 |
| 115487 | 170 | 115610 | 189 | 115696 | 114 | 115768 | 124 | 115840 | 125 |
| 115488 | 170 | 115611 | 189 | 115697 | 114 | 115769 | 124 | 115841 | 125 |
| 115489 | 170 | 115612 | 189 | 115698 | 114 | 115770 | 124 | 115842 | 125 |
| 115490 | 170 | 115613 | 189 | 115699 | 114 | 115771 | 124 | 115843 | 125 |
| 115491 | 170 | 115614 | 189 | 115700 | 114 | 115772 | 124 | 115844 | 125 |
| 115492 | 170 | 115615 | 189 | 115701 | 114 | 115773 | 124 | 115845 | 125 |
| 115493 | 170 | 115616 | 189 | 115702 | 117 | 115774 | 124 | 115846 | 125 |
| 115494 | 170 | 115617 | 189 | 115703 | 117 | 115775 | 124 | 115847 | 125 |
| 115495 | 170 | 115618 | 189 | 115704 | 117 | 115776 | 124 | 115848 | 125 |
| 115496 | 170 | 115619 | 189 | 115705 | 117 | 115777 | 124 | 115849 | 125 |
| 115497 | 170 | 115628 | 191 | 115706 | 117 | 115778 | 124 | 115850 | 125 |
| 115498 | 170 | 115629 | 191 | 115707 | 117 | 115779 | 124 | 115851 | 125 |
| 115499 | 170 | 115630 | 191 | 115708 | 117 | 115780 | 124 | 115852 | 125 |
| 115500 | 170 | 115631 | 191 | 115709 | 117 | 115781 | 124 | 115853 | 125 |
| 115501 | 170 | 115632 | 191 | 115710 | 117 | 115782 | 124 | 115854 | 125 |
| 115502 | 170 | 115633 | 191 | 115711 | 117 | 115783 | 124 | 115855 | 125 |
| 115503 | 171 | 115634 | 191 | 115712 | 117 | 115784 | 124 | 115856 | 125 |
| 115506 | 160 | 115635 | 191 | 115713 | 117 | 115785 | 124 | 115857 | 125 |
| 115507 | 160 | 115636 | 191 | 115714 | 117 | 115786 | 124 | 115858 | 125 |
| 115508 | 160 | 115637 | 191 | 115715 | 117 | 115787 | 124 | 115859 | 125 |
| 115509 | 160 | 115638 | 191 | 115716 | 117 | 115788 | 124 | 115860 | 125 |
| 115511 | 174 | 115639 | 191 | 115717 | 117 | 115789 | 124 | 115861 | 125 |
| 115512 | 174 | 115640 | 191 | 115718 | 117 | 115790 | 124 | 115862 | 125 |
| 115513 | 175 | 115641 | 191 | 115719 | 117 | 115791 | 124 | 115863 | 125 |
| 115514 | 175 | 115642 | 191 | 115720 | 117 | 115792 | 124 | 115864 | 125 |
| 115515 | 175 | 115643 | 191 | 115721 | 123 | 115793 | 124 | 115865 | 126 |
| 115516 | 176 | 115644 | 191 | 115722 | 123 | 115794 | 124 | 115866 | 126 |
| 115517 | 176 | 115645 | 191 | 115723 | 123 | 115795 | 124 | 115867 | 126 |
| 115518 | 176 | 115646 | 191 | 115724 | 123 | 115796 | 124 | 115868 | 126 |
| 115541 | 181 | 115647 | 191 | 115725 | 123 | 115797 | 124 | 115869 | 126 |
| 115542 | 181 | 115648 | 191 | 115726 | 123 | 115798 | 124 | 115870 | 126 |
| 115543 | 181 | 115649 | 191 | 115727 | 123 | 115799 | 124 | 115871 | 126 |
| 115544 | 181 | 115651 | 191 | 115728 | 123 | 115800 | 124 | 115872 | 126 |

| Code GIF | Pages | Code GIF | Pages | Code GIF | Pages | Code GIF | Pages | Code GIF | Pages |
|----------|-------|----------|-------|----------|-------|----------|-------|----------|-------|
| 115873 | 126 | 115950 | 138 | 116029 | 143 | 116110 | 156 | 116195 | 174 |
| 115874 | 126 | 115951 | 138 | 116030 | 143 | 116111 | 156 | 116196 | 174 |
| 115875 | 126 | 115952 | 159 | 116031 | 143 | 116112 | 156 | 116199 | 175 |
| 115876 | 126 | 115953 | 159 | 116032 | 143 | 116113 | 156 | 116200 | 176 |
| 115877 | 127 | 115954 | 138 | 116033 | 143 | 116114 | 156 | 116201 | 177 |
| 115878 | 128 | 115955 | 158 | 116034 | 143 | 116115 | 156 | 116202 | 177 |
| 115879 | 128 | 115956 | 136 | 116035 | 143 | 116116 | 156 | 116203 | 177 |
| 115880 | 128 | 115957 | 136 | 116036 | 152 | 116117 | 156 | 116204 | 177 |
| 115881 | 128 | 115958 | 136 | 116037 | 152 | 116118 | 156 | 116205 | 177 |
| 115882 | 128 | 115959 | 136 | 116038 | 152 | 116119 | 156 | 116206 | 178 |
| 115883 | 128 | 115960 | 136 | 116039 | 152 | 116120 | 157 | 116207 | 178 |
| 115887 | 128 | 115961 | 136 | 116040 | 152 | 116121 | 157 | 116208 | 178 |
| 115888 | 128 | 115962 | 136 | 116041 | 159 | 116122 | 157 | 116209 | 178 |
| 115889 | 128 | 115963 | 136 | 116042 | 159 | 116123 | 157 | 116210 | 179 |
| 115890 | 128 | 115965 | 136 | 116043 | 152 | 116124 | 157 | 116211 | 179 |
| 115891 | 128 | 115967 | 139 | 116044 | 152 | 116125 | 157 | 116212 | 179 |
| 115892 | 128 | 115968 | 139 | 116045 | 152 | 116126 | 157 | 116213 | 179 |
| 115893 | 128 | 115969 | 139 | 116046 | 152 | 116127 | 163 | 116214 | 180 |
| 115894 | 128 | 115970 | 139 | 116047 | 152 | 116128 | 163 | 116215 | 180 |
| 115895 | 128 | 115971 | 139 | 116048 | 152 | 116129 | 163 | 116216 | 182 |
| 115896 | 129 | 115972 | 139 | 116049 | 152 | 116130 | 163 | 116217 | 182 |
| 115898 | 129 | 115973 | 139 | 116050 | 152 | 116131 | 163 | 116218 | 184 |
| 115899 | 129 | 115974 | 139 | 116051 | 152 | 116132 | 163 | 116219 | 184 |
| 115900 | 129 | 115975 | 139 | 116052 | 152 | 116133 | 163 | 116220 | 184 |
| 115901 | 129 | 115976 | 139 | 116053 | 152 | 116134 | 157 | 116221 | 185 |
| 115902 | 129 | 115977 | 139 | 116063 | 153 | 116136 | 157 | 116222 | 185 |
| 115903 | 129 | 115978 | 139 | 116064 | 153 | 116137 | 157 | 116223 | 189 |
| 115904 | 129 | 115979 | 139 | 116065 | 153 | 116138 | 161 | 116224 | 189 |
| 115905 | 129 | 115980 | 139 | 116066 | 153 | 116139 | 161 | 116225 | 189 |
| 115906 | 129 | 115981 | 139 | 116067 | 154 | 116140 | 161 | 116226 | 189 |
| 115907 | 129 | 115982 | 141 | 116068 | 155 | 116141 | 161 | 116227 | 189 |
| 115908 | 129 | 115983 | 141 | 116069 | 155 | 116142 | 161 | 116228 | 186 |
| 115910 | 129 | 115984 | 141 | 116070 | 155 | 116143 | 162 | 116229 | 192 |
| 115911 | 129 | 115985 | 141 | 116071 | 155 | 116144 | 162 | 116230 | 196 |
| 115912 | 129 | 115986 | 141 | 116072 | 155 | 116145 | 162 | 116231 | 196 |
| 115913 | 129 | 115987 | 141 | 116073 | 155 | 116146 | 162 | 116232 | 197 |
| 115914 | 129 | 115988 | 141 | 116074 | 155 | 116147 | 157 | 116233 | 197 |
| 115915 | 129 | 115989 | 141 | 116075 | 155 | 116148 | 157 | 116234 | 197 |
| 115916 | 129 | 115990 | 141 | 116076 | 155 | 116149 | 157 | 116235 | 197 |
| 115917 | 129 | 115991 | 141 | 116077 | 155 | 116150 | 157 | 116236 | 194 |
| 115918 | 129 | 115992 | 142 | 116078 | 155 | 116151 | 157 | 116237 | 194 |
| 115919 | 129 | 115993 | 142 | 116079 | 155 | 116152 | 157 | 116238 | 194 |
| 115920 | 129 | 115994 | 142 | 116080 | 155 | 116153 | 156 | 116239 | 194 |
| 115921 | 129 | 115995 | 142 | 116081 | 155 | 116154 | 156 | 116240 | 194 |
| 115922 | 129 | 115996 | 142 | 116082 | 155 | 116155 | 156 | 116241 | 197 |
| 115923 | 129 | 115997 | 142 | 116083 | 155 | 116156 | 156 | 116242 | 197 |
| 115924 | 129 | 115998 | 142 | 116084 | 155 | 116160 | 156 | 116243 | 197 |
| 115925 | 129 | 115999 | 142 | 116085 | 155 | 116161 | 156 | 116244 | 195 |
| 115926 | 129 | 116000 | 142 | 116086 | 155 | 116171 | 161 | 116245 | 195 |
| 115927 | 129 | 116001 | 142 | 116087 | 155 | 116172 | 161 | 116246 | 195 |
| 115928 | 129 | 116002 | 142 | 116088 | 156 | 116173 | 161 | 116247 | 195 |
| 115929 | 131 | 116003 | 142 | 116089 | 156 | 116174 | 161 | 116248 | 194 |
| 115930 | 131 | 116004 | 142 | 116090 | 156 | 116175 | 162 | 116249 | 198 |
| 115931 | 131 | 116005 | 142 | 116091 | 156 | 116176 | 162 | 116250 | 198 |
| 115932 | 131 | 116006 | 142 | 116092 | 156 | 116177 | 160 | 116251 | 198 |
| 115933 | 131 | 116007 | 142 | 116093 | 156 | 116178 | 160 | 116252 | 199 |
| 115934 | 131 | 116008 | 142 | 116094 | 156 | 116179 | 160 | 116253 | 200 |
| 115935 | 131 | 116013 | 142 | 116095 | 156 | 116180 | 170 | 116254 | 200 |
| 115936 | 131 | 116014 | 142 | 116096 | 159 | 116181 | 171 | 116255 | 200 |
| 115937 | 131 | 116015 | 142 | 116097 | 159 | 116182 | 171 | 116256 | 201 |
| 115938 | 131 | 116016 | 142 | 116098 | 160 | 116183 | 167 | 116257 | 201 |
| 115939 | 131 | 116018 | 142 | 116099 | 160 | 116184 | 167 | 116258 | 201 |
| 115940 | 135 | 116019 | 143 | 116100 | 160 | 116185 | 167 | 116259 | 202 |
| 115941 | 135 | 116020 | 143 | 116101 | 160 | 116186 | 173 | 116260 | 201 |
| 115942 | 135 | 116021 | 143 | 116102 | 160 | 116187 | 173 | 116261 | 202 |
| 115943 | 135 | 116022 | 143 | 116103 | 160 | 116188 | 173 | 116262 | 202 |
| 115944 | 135 | 116023 | 143 | 116104 | 156 | 116189 | 173 | 116263 | 208 |
| 115945 | 135 | 116024 | 143 | 116105 | 156 | 116190 | 173 | 116264 | 208 |
| 115946 | 135 | 116025 | 143 | 116106 | 156 | 116191 | 173 | 116265 | 211 |
| 115947 | 135 | 116026 | 143 | 116107 | 156 | 116192 | 173 | 116266 | 211 |
| 115948 | 135 | 116027 | 143 | 116108 | 156 | 116193 | 173 | 116267 | 211 |
| 115949 | 135 | 116028 | 143 | 116109 | 156 | 116194 | 173 | 116268 | 211 |

INDEX

par référence

| Code GIF | Pages | Code GIF | Pages | Code GIF | Pages | Code GIF | Pages | Code GIF | Pages |
|----------|-------|----------|-------|----------|-------|----------|-------|----------|-------|
| 116269 | 211 | 116341 | 222 | 116413 | 224 | 116485 | 223 | 122627 | 150 |
| 116270 | 211 | 116342 | 222 | 116414 | 224 | 116486 | 223 | 122628 | 150 |
| 116271 | 211 | 116343 | 222 | 116415 | 224 | 116487 | 223 | 122629 | 150 |
| 116272 | 211 | 116344 | 222 | 116416 | 224 | 116488 | 223 | 122630 | 150 |
| 116273 | 211 | 116345 | 222 | 116417 | 224 | 116489 | 223 | 122631 | 150 |
| 116274 | 210 | 116346 | 222 | 116418 | 224 | 116490 | 223 | 122632 | 150 |
| 116275 | 210 | 116347 | 222 | 116419 | 224 | 116491 | 223 | 122721 | 159 |
| 116276 | 210 | 116348 | 222 | 116420 | 224 | 116492 | 223 | 122735 | 201 |
| 116277 | 213 | 116349 | 222 | 116421 | 224 | 116493 | 223 | 122789 | 146 |
| 116278 | 213 | 116350 | 222 | 116422 | 224 | 116494 | 223 | 122790 | 146 |
| 116279 | 213 | 116351 | 222 | 116423 | 224 | 116495 | 223 | 122802 | 170 |
| 116280 | 213 | 116352 | 222 | 116424 | 224 | 116496 | 223 | 122806 | 172 |
| 116281 | 213 | 116353 | 222 | 116425 | 224 | 116497 | 226 | 122807 | 173 |
| 116282 | 213 | 116354 | 222 | 116426 | 224 | 116498 | 226 | 122808 | 172 |
| 116283 | 213 | 116355 | 222 | 116427 | 224 | 116499 | 226 | 122971 | 146 |
| 116284 | 217 | 116356 | 222 | 116428 | 224 | 116500 | 226 | 122972 | 146 |
| 116285 | 217 | 116357 | 222 | 116429 | 224 | 116501 | 226 | 122973 | 146 |
| 116286 | 217 | 116358 | 222 | 116430 | 224 | 116502 | 226 | 122974 | 146 |
| 116287 | 217 | 116359 | 222 | 116431 | 224 | 116503 | 226 | 122975 | 146 |
| 116288 | 216 | 116360 | 222 | 116432 | 224 | 116504 | 226 | 122976 | 146 |
| 116289 | 216 | 116361 | 222 | 116433 | 224 | 116505 | 226 | 122977 | 146 |
| 116290 | 216 | 116362 | 222 | 116434 | 224 | 116506 | 226 | 122978 | 146 |
| 116291 | 216 | 116363 | 222 | 116435 | 224 | 116507 | 226 | 122979 | 146 |
| 116292 | 216 | 116364 | 222 | 116436 | 224 | 116508 | 226 | 122980 | 146 |
| 116293 | 216 | 116365 | 222 | 116437 | 224 | 116509 | 226 | 122987 | 146 |
| 116294 | 216 | 116366 | 222 | 116438 | 224 | 116510 | 226 | 122988 | 146 |
| 116295 | 216 | 116367 | 222 | 116439 | 224 | 116511 | 226 | 122989 | 146 |
| 116296 | 216 | 116368 | 222 | 116440 | 224 | 116512 | 226 | 122990 | 146 |
| 116297 | 216 | 116369 | 222 | 116441 | 224 | 116513 | 226 | 122991 | 146 |
| 116298 | 216 | 116370 | 222 | 116442 | 224 | 116514 | 226 | 122992 | 146 |
| 116299 | 216 | 116371 | 222 | 116443 | 224 | 116515 | 226 | 122993 | 146 |
| 116300 | 216 | 116372 | 222 | 116444 | 224 | 116516 | 226 | 122994 | 146 |
| 116301 | 216 | 116373 | 222 | 116445 | 224 | 116517 | 226 | 122995 | 146 |
| 116302 | 216 | 116374 | 222 | 116446 | 224 | 116518 | 226 | 122996 | 146 |
| 116303 | 216 | 116375 | 222 | 116447 | 224 | 116519 | 226 | 122997 | 146 |
| 116304 | 216 | 116376 | 222 | 116448 | 224 | 116520 | 226 | 122998 | 146 |
| 116305 | 216 | 116377 | 222 | 116449 | 224 | 116521 | 226 | 122999 | 146 |
| 116306 | 216 | 116378 | 222 | 116450 | 224 | 116522 | 226 | 123000 | 146 |
| 116307 | 216 | 116379 | 222 | 116451 | 224 | 116523 | 226 | 123001 | 146 |
| 116308 | 217 | 116380 | 222 | 116452 | 224 | 116524 | 226 | 123002 | 146 |
| 116309 | 217 | 116381 | 222 | 116453 | 224 | 122586 | 146 | 123003 | 146 |
| 116310 | 217 | 116382 | 222 | 116454 | 224 | 122587 | 146 | 123004 | 146 |
| 116311 | 217 | 116383 | 222 | 116455 | 224 | 122588 | 146 | 123005 | 146 |
| 116312 | 217 | 116384 | 222 | 116456 | 224 | 122589 | 146 | 123006 | 146 |
| 116313 | 217 | 116385 | 222 | 116457 | 224 | 122590 | 146 | 123007 | 146 |
| 116314 | 217 | 116386 | 222 | 116458 | 224 | 122591 | 146 | 123008 | 146 |
| 116315 | 217 | 116387 | 222 | 116459 | 224 | 122592 | 146 | 123009 | 146 |
| 116316 | 222 | 116388 | 222 | 116460 | 224 | 122593 | 146 | 123010 | 146 |
| 116317 | 222 | 116389 | 222 | 116461 | 224 | 122594 | 146 | 123011 | 146 |
| 116318 | 222 | 116390 | 222 | 116462 | 224 | 122595 | 146 | 123012 | 146 |
| 116319 | 222 | 116391 | 222 | 116463 | 224 | 122596 | 151 | 123013 | 146 |
| 116320 | 222 | 116392 | 222 | 116464 | 224 | 122597 | 151 | 123014 | 146 |
| 116321 | 222 | 116393 | 222 | 116465 | 224 | 122598 | 151 | 123015 | 146 |
| 116322 | 222 | 116394 | 222 | 116466 | 224 | 122599 | 151 | 123016 | 146 |
| 116323 | 222 | 116395 | 222 | 116467 | 224 | 122600 | 151 | 123017 | 146 |
| 116324 | 222 | 116396 | 222 | 116468 | 224 | 122606 | 151 | 123018 | 146 |
| 116325 | 222 | 116397 | 222 | 116469 | 223 | 122607 | 151 | 123019 | 146 |
| 116326 | 222 | 116398 | 222 | 116470 | 223 | 122608 | 151 | 123020 | 146 |
| 116327 | 222 | 116399 | 222 | 116471 | 223 | 122609 | 151 | 123021 | 146 |
| 116328 | 222 | 116400 | 222 | 116472 | 223 | 122610 | 151 | 123022 | 146 |
| 116329 | 222 | 116401 | 222 | 116473 | 223 | 122611 | 151 | 123023 | 146 |
| 116330 | 222 | 116402 | 222 | 116474 | 223 | 122612 | 151 | 123024 | 146 |
| 116331 | 222 | 116403 | 222 | 116475 | 223 | 122613 | 151 | 123025 | 146 |
| 116332 | 222 | 116404 | 222 | 116476 | 223 | 122614 | 151 | 123026 | 146 |
| 116333 | 222 | 116405 | 222 | 116477 | 223 | 122619 | 151 | 123027 | 146 |
| 116334 | 222 | 116406 | 222 | 116478 | 223 | 122620 | 151 | 123028 | 146 |
| 116335 | 222 | 116407 | 222 | 116479 | 223 | 122621 | 151 | 123031 | 146 |
| 116336 | 222 | 116408 | 222 | 116480 | 223 | 122622 | 151 | 123032 | 146 |
| 116337 | 222 | 116409 | 222 | 116481 | 223 | 122623 | 150 | 123033 | 146 |
| 116338 | 222 | 116410 | 222 | 116482 | 223 | 122624 | 150 | 123034 | 146 |
| 116339 | 222 | 116411 | 222 | 116483 | 223 | 122625 | 150 | 123035 | 146 |
| 116340 | 222 | 116412 | 222 | 116484 | 223 | 122626 | 150 | 123036 | 146 |

| Code GIF | Pages | Code GIF | Pages | Code GIF | Pages | Code GIF | Pages | Code GIF | Pages |
|----------|-------|----------|-------|----------|-------|----------|-------|----------|-------|
| 123037 | 146 | 123904 | 150 | 124181 | 149 | 124383 | 183 | 200105 | 46 |
| 123121 | 138 | 123905 | 150 | 124182 | 149 | 124384 | 183 | 200106 | 46 |
| 123122 | 138 | 123906 | 150 | 124183 | 149 | 124385 | 183 | 200112 | 50 |
| 123123 | 138 | 123919 | 150 | 124184 | 149 | 124386 | 183 | 200115 | 56 |
| 123130 | 150 | 123920 | 150 | 124210 | 149 | 124387 | 183 | 200116 | 45 |
| 123131 | 150 | 123921 | 150 | 124211 | 149 | 124388 | 183 | 200117 | 45 |
| 123132 | 150 | 123922 | 150 | 124212 | 149 | 124389 | 183 | 200118 | 45 |
| 123133 | 150 | 123923 | 150 | 124213 | 149 | 124390 | 183 | 200121 | 33 |
| 123147 | 169 | 123924 | 150 | 124214 | 149 | 124391 | 183 | 200123 | 13 |
| 123157 | 172 | 123937 | 176 | 124215 | 149 | 124506 | 120 | 200124 | 13 |
| 123216 | 185 | 123942 | 169 | 124216 | 176 | 124507 | 120 | 200125 | 56 |
| 123227 | 186 | 123943 | 169 | 124218 | 176 | 124508 | 120 | 200128 | 13 |
| 123244 | 184 | 123944 | 169 | 124228 | 120 | 124509 | 122 | 200132 | 13 |
| 123245 | 184 | 123945 | 169 | 124229 | 120 | 124510 | 122 | 200140 | 23 |
| 123246 | 184 | 123951 | 161 | 124230 | 120 | 124511 | 121 | 200155 | 56 |
| 123247 | 184 | 123952 | 161 | 124267 | 118 | 124512 | 121 | 200178 | 20 |
| 123248 | 184 | 123953 | 161 | 124268 | 118 | 124513 | 121 | 200179 | 20 |
| 123258 | 205 | 123976 | 156 | 124269 | 118 | 124514 | 121 | 200180 | 20 |
| 123260 | 210 | 123977 | 156 | 124270 | 118 | 124515 | 121 | 200181 | 20 |
| 123408 | 171 | 123978 | 156 | 124271 | 118 | 124516 | 121 | 200182 | 20 |
| 123452 | 186 | 123979 | 156 | 124272 | 118 | 124517 | 121 | 200183 | 20 |
| 123464 | 209 | 123980 | 156 | 124273 | 118 | 124518 | 121 | 200184 | 20 |
| 123466 | 209 | 123981 | 156 | 124274 | 118 | 124519 | 120 | 200185 | 20 |
| 123502 | 196 | 123982 | 156 | 124275 | 118 | 124520 | 120 | 200186 | 20 |
| 123503 | 196 | 123984 | 156 | 124276 | 118 | 124521 | 120 | 200187 | 20 |
| 123504 | 196 | 123992 | 152 | 124277 | 118 | 124522 | 120 | 200188 | 20 |
| 123505 | 196 | 123993 | 152 | 124278 | 118 | 124523 | 120 | 200191 | 20 |
| 123506 | 196 | 124030 | 182 | 124279 | 118 | 124524 | 120 | 200192 | 23 |
| 123507 | 195 | 124057 | 193 | 124280 | 118 | 124525 | 120 | 200203 | 30 |
| 123508 | 195 | 124058 | 193 | 124281 | 118 | 124526 | 120 | 200220 | 50 |
| 123516 | 198 | 124059 | 193 | 124282 | 118 | 124527 | 118 | 200221 | 39 |
| 123517 | 198 | 124060 | 193 | 124292 | 121 | 124528 | 118 | 200222 | 39 |
| 123518 | 198 | 124063 | 196 | 124293 | 121 | 124529 | 118 | 200237 | 30 |
| 123539 | 177 | 124064 | 196 | 124294 | 121 | 124530 | 118 | 200324 | 50 |
| 123540 | 177 | 124070 | 193 | 124295 | 121 | 124531 | 118 | 200325 | 56 |
| 123542 | 177 | 124071 | 193 | 124320 | 159 | 124532 | 118 | 200355 | 56 |
| 123646 | 167 | 124072 | 193 | 124333 | 207 | 124533 | 118 | 200360 | 214 |
| 123647 | 167 | 124073 | 193 | 124334 | 207 | 124534 | 118 | 200401 | 68 |
| 123649 | 173 | 124089 | 192 | 124347 | 120 | 124535 | 118 | 200402 | 68 |
| 123650 | 173 | 124090 | 192 | 124348 | 120 | 124536 | 118 | 200404 | 68 |
| 123734 | 204 | 124091 | 192 | 124349 | 120 | 124537 | 118 | 200425 | 56 |
| 123736 | 192 | 124092 | 192 | 124350 | 122 | 124538 | 118 | 200455 | 56 |
| 123737 | 192 | 124093 | 192 | 124351 | 122 | 124539 | 118 | 200475 | 76 |
| 123805 | 184 | 124115 | 144 | 124352 | 122 | 124541 | 131 | 200476 | 76 |
| 123806 | 206 | 124116 | 144 | 124353 | 122 | 124619 | 139 | 200525 | 56 |
| 123808 | 146 | 124117 | 144 | 124354 | 122 | 124623 | 171 | 200547 | 58 |
| 123809 | 146 | 124118 | 144 | 124355 | 122 | 124625 | 176 | 200555 | 56 |
| 123810 | 146 | 124119 | 144 | 124356 | 122 | 124626 | 177 | 200556 | 43 |
| 123811 | 146 | 124120 | 144 | 124357 | 122 | 124629 | 174 | 200558 | 38 |
| 123812 | 146 | 124121 | 144 | 124358 | 122 | 124647 | 161 | 200559 | 43 |
| 123813 | 146 | 124122 | 144 | 124359 | 122 | 124648 | 161 | 200563 | 19 |
| 123876 | 136 | 124130 | 173 | 124360 | 122 | 124649 | 167 | 200564 | 19 |
| 123877 | 136 | 124131 | 173 | 124361 | 122 | 124650 | 167 | 200565 | 19 |
| 123878 | 136 | 124132 | 173 | 124363 | 122 | 124651 | 177 | 200566 | 19 |
| 123879 | 136 | 124133 | 173 | 124364 | 122 | 124652 | 175 | 200567 | 22 |
| 123882 | 136 | 124137 | 198 | 124365 | 122 | 124655 | 132 | 200607 | 23 |
| 123884 | 136 | 124151 | 134 | 124366 | 122 | 124656 | 214 | 200609 | 25 |
| 123886 | 132 | 124152 | 134 | 124367 | 122 | 200001 | 33 | 200610 | 25 |
| 123888 | 132 | 124153 | 134 | 124368 | 122 | 200006 | 51 | 200617 | 23 |
| 123889 | 132 | 124154 | 134 | 124369 | 122 | 200007 | 51 | 200618 | 23 |
| 123890 | 134 | 124157 | 111 | 124371 | 122 | 200011 | 57 | 200619 | 23 |
| 123891 | 134 | 124158 | 111 | 124372 | 122 | 200013 | 51 | 200620 | 23 |
| 123892 | 134 | 124159 | 111 | 124373 | 122 | 200014 | 51 | 200625 | 56 |
| 123893 | 134 | 124160 | 111 | 124374 | 122 | 200015 | 50 | 200626 | 41 |
| 123894 | 134 | 124161 | 111 | 124375 | 183 | 200016 | 45 | 200627 | 41 |
| 123895 | 145 | 124162 | 111 | 124376 | 183 | 200017 | 45 | 200628 | 41 |
| 123898 | 145 | 124175 | 149 | 124377 | 183 | 200018 | 45 | 200629 | 41 |
| 123899 | 145 | 124176 | 149 | 124378 | 183 | 200042 | 51 | 200631 | 41 |
| 123900 | 145 | 124177 | 149 | 124379 | 183 | 200081 | 90 | 200644 | 49 |
| 123901 | 150 | 124178 | 149 | 124380 | 183 | 200083 | 90 | 200645 | 48 |
| 123902 | 150 | 124179 | 149 | 124381 | 183 | 200085 | 90 | 200646 | 48 |
| 123903 | 150 | 124180 | 149 | 124382 | 183 | 200100 | 33 | 200647 | 48 |

INDEX

par référence

| Code GIF | Pages | Code GIF | Pages | Code GIF | Pages | Code GIF | Pages | Code GIF | Pages |
|----------|-------|----------|-------|----------|-------|----------|-------|----------|-------|
| 200648 | 48 | 200846 | 78 | 201046 | 67 | 201405 | 49 | 201696 | 32 |
| 200649 | 48 | 200847 | 78 | 201047 | 67 | 201406 | 49 | 201697 | 32 |
| 200650 | 49 | 200904 | 89 | 201048 | 215 | 201407 | 49 | 201698 | 44 |
| 200651 | 49 | 200905 | 89 | 201051 | 66 | 201408 | 49 | 201700 | 7 |
| 200652 | 49 | 200906 | 89 | 201052 | 66 | 201410 | 49 | 201701 | 23 |
| 200655 | 56 | 200907 | 89 | 201053 | 66 | 201411 | 49 | 201702 | 22 |
| 200664 | 49 | 200913 | 51 | 201054 | 66 | 201412 | 49 | 201703 | 25 |
| 200665 | 49 | 200914 | 51 | 201061 | 58 | 201414 | 53 | 201704 | 25 |
| 200666 | 49 | 200915 | 48 | 201063 | 81 | 201415 | 53 | 201705 | 25 |
| 200667 | 49 | 200916 | 48 | 201064 | 81 | 201416 | 53 | 201706 | 25 |
| 200668 | 49 | 200917 | 48 | 201086 | 58 | 201417 | 53 | 201708 | 25 |
| 200669 | 49 | 200918 | 48 | 201093 | 90 | 201418 | 53 | 201711 | 24 |
| 200670 | 49 | 200919 | 48 | 201111 | 66 | 201419 | 53 | 201713 | 27 |
| 200671 | 49 | 200920 | 48 | 201112 | 66 | 201420 | 53 | 201714 | 27 |
| 200672 | 49 | 200921 | 49 | 201117 | 58 | 201421 | 53 | 201715 | 56 |
| 200673 | 49 | 200922 | 49 | 201118 | 43 | 201423 | 190 | 201716 | 56 |
| 200674 | 49 | 200926 | 16 | 201119 | 43 | 201424 | 190 | 201718 | 61 |
| 200675 | 49 | 200927 | 16 | 201127 | 44 | 201426 | 13 | 201720 | 61 |
| 200676 | 49 | 200929 | 16 | 201129 | 87 | 201427 | 190 | 201721 | 61 |
| 200677 | 49 | 200930 | 16 | 201130 | 87 | 201428 | 190 | 201722 | 61 |
| 200678 | 49 | 200931 | 16 | 201131 | 87 | 201430 | 13 | 201723 | 61 |
| 200679 | 49 | 200933 | 16 | 201142 | 31 | 201436 | 13 | 201724 | 61 |
| 200680 | 49 | 200934 | 19 | 201143 | 31 | 201440 | 13 | 201725 | 56 |
| 200681 | 49 | 200937 | 20 | 201144 | 31 | 201489 | 64 | 201726 | 56 |
| 200682 | 49 | 200938 | 20 | 201146 | 31 | 201494 | 64 | 201727 | 61 |
| 200683 | 49 | 200939 | 25 | 201147 | 31 | 201495 | 64 | 201729 | 61 |
| 200684 | 49 | 200971 | 218 | 201148 | 31 | 201496 | 66 | 201731 | 64 |
| 200685 | 49 | 200981 | 219 | 201208 | 30 | 201497 | 66 | 201732 | 65 |
| 200686 | 49 | 200982 | 219 | 201212 | 30 | 201498 | 66 | 201733 | 65 |
| 200687 | 49 | 200983 | 219 | 201216 | 7 | 201499 | 66 | 201735 | 56 |
| 200688 | 49 | 200984 | 219 | 201218 | 7 | 201500 | 66 | 201753 | 7 |
| 200689 | 49 | 200985 | 219 | 201220 | 7 | 201501 | 66 | 201754 | 7 |
| 200691 | 49 | 200986 | 219 | 201221 | 78 | 201516 | 73 | 201755 | 56 |
| 200692 | 49 | 200987 | 219 | 201222 | 78 | 201517 | 73 | 201756 | 7 |
| 200693 | 49 | 200988 | 219 | 201224 | 7 | 201519 | 58 | 201757 | 7 |
| 200694 | 49 | 200989 | 219 | 201228 | 7 | 201526 | 103 | 201758 | 7 |
| 200695 | 49 | 200990 | 219 | 201229 | 41 | 201527 | 53 | 201759 | 7 |
| 200696 | 51 | 200991 | 219 | 201230 | 41 | 201536 | 13 | 201760 | 7 |
| 200697 | 51 | 200992 | 219 | 201232 | 7 | 201538 | 13 | 201761 | 7 |
| 200699 | 35 | 200999 | 214 | 201235 | 63 | 201540 | 13 | 201762 | 7 |
| 200700 | 25 | 201000 | 27 | 201236 | 7 | 201541 | 102 | 201763 | 7 |
| 200702 | 23 | 201001 | 27 | 201240 | 7 | 201542 | 102 | 201764 | 7 |
| 200703 | 23 | 201002 | 27 | 201245 | 7 | 201543 | 102 | 201765 | 7 |
| 200704 | 23 | 201003 | 27 | 201248 | 86 | 201544 | 102 | 201766 | 7 |
| 200706 | 22 | 201004 | 27 | 201249 | 86 | 201545 | 102 | 201768 | 7 |
| 200714 | 22 | 201005 | 21 | 201250 | 7 | 201546 | 102 | 201769 | 7 |
| 200730 | 22 | 201006 | 21 | 201266 | 87 | 201547 | 102 | 201770 | 7 |
| 200732 | 210 | 201009 | 188 | 201269 | 87 | 201601 | 11 | 201771 | 7 |
| 200734 | 46 | 201012 | 188 | 201272 | 215 | 201602 | 106 | 201772 | 7 |
| 200743 | 22 | 201016 | 8 | 201315 | 61 | 201603 | 106 | 201773 | 7 |
| 200760 | 22 | 201017 | 8 | 201316 | 61 | 201604 | 106 | 201774 | 7 |
| 200770 | 22 | 201018 | 8 | 201317 | 61 | 201605 | 106 | 201775 | 7 |
| 200771 | 27 | 201019 | 8 | 201323 | 43 | 201606 | 106 | 201776 | 7 |
| 200775 | 28 | 201020 | 8 | 201325 | 60 | 201607 | 106 | 201777 | 7 |
| 200776 | 28 | 201024 | 8 | 201326 | 60 | 201608 | 106 | 201778 | 7 |
| 200784 | 46 | 201028 | 8 | 201327 | 60 | 201609 | 106 | 201780 | 7 |
| 200785 | 22 | 201029 | 215 | 201334 | 65 | 201610 | 106 | 201781 | 7 |
| 200786 | 190 | 201030 | 215 | 201363 | 53 | 201611 | 106 | 201782 | 7 |
| 200787 | 190 | 201031 | 215 | 201364 | 53 | 201612 | 106 | 201783 | 7 |
| 200788 | 190 | 201032 | 215 | 201365 | 53 | 201613 | 106 | 201784 | 7 |
| 200789 | 190 | 201033 | 215 | 201366 | 53 | 201614 | 106 | 201785 | 7 |
| 200790 | 190 | 201034 | 215 | 201386 | 45 | 201615 | 106 | 201786 | 7 |
| 200791 | 190 | 201035 | 215 | 201387 | 45 | 201617 | 28 | 201787 | 7 |
| 200808 | 63 | 201036 | 215 | 201388 | 45 | 201618 | 28 | 201788 | 7 |
| 200809 | 76 | 201038 | 215 | 201389 | 45 | 201619 | 28 | 201789 | 7 |
| 200810 | 59 | 201039 | 215 | 201390 | 45 | 201621 | 50 | 201790 | 7 |
| 200811 | 59 | 201040 | 215 | 201391 | 45 | 201622 | 50 | 201792 | 7 |
| 200820 | 81 | 201041 | 67 | 201393 | 45 | 201623 | 51 | 201793 | 7 |
| 200821 | 52 | 201042 | 67 | 201400 | 49 | 201625 | 11 | 201794 | 7 |
| 200842 | 23 | 201043 | 67 | 201401 | 49 | 201626 | 11 | 201795 | 7 |
| 200843 | 23 | 201044 | 67 | 201402 | 49 | 201627 | 11 | 201796 | 7 |
| 200844 | 23 | 201045 | 67 | 201403 | 49 | 201629 | 11 | 201797 | 7 |

| Code GIF | Pages | Code GIF | Pages | Code GIF | Pages | Code GIF | Pages | Code GIF | Pages |
|----------|-------|----------|-------|----------|-------|----------|-------|----------|-------|
| 201798 | 7 | 202096 | 5 | 202227 | 17 | 202366 | 19 | 202536 | 27 |
| 201799 | 7 | 202097 | 5 | 202229 | 19 | 202367 | 19 | 202537 | 27 |
| 201800 | 7 | 202098 | 5 | 202230 | 33 | 202368 | 19 | 202538 | 27 |
| 201813 | 19 | 202099 | 5 | 202231 | 19 | 202369 | 19 | 202539 | 27 |
| 201816 | 35 | 202100 | 30 | 202232 | 19 | 202370 | 19 | 202540 | 27 |
| 201817 | 35 | 202101 | 4 | 202233 | 19 | 202371 | 19 | 202541 | 27 |
| 201818 | 36 | 202102 | 4 | 202234 | 19 | 202372 | 19 | 202542 | 27 |
| 201819 | 36 | 202103 | 4 | 202235 | 33 | 202373 | 19 | 202543 | 27 |
| 201820 | 36 | 202104 | 4 | 202236 | 19 | 202374 | 19 | 202544 | 27 |
| 201821 | 36 | 202105 | 4 | 202237 | 19 | 202375 | 19 | 202557 | 41 |
| 201822 | 36 | 202106 | 4 | 202238 | 19 | 202380 | 31 | 202558 | 41 |
| 201829 | 29 | 202107 | 4 | 202239 | 19 | 202400 | 22 | 202559 | 41 |
| 201830 | 48 | 202108 | 4 | 202240 | 33 | 202401 | 22 | 202584 | 74 |
| 201886 | 203 | 202109 | 4 | 202241 | 19 | 202402 | 22 | 202585 | 74 |
| 201887 | 203 | 202111 | 4 | 202242 | 8 | 202405 | 22 | 202586 | 74 |
| 201888 | 203 | 202112 | 36 | 202243 | 8 | 202406 | 213 | 202587 | 74 |
| 201889 | 203 | 202113 | 4 | 202244 | 8 | 202407 | 22 | 202588 | 74 |
| 201890 | 203 | 202114 | 4 | 202245 | 8 | 202421 | 25 | 202589 | 74 |
| 201891 | 203 | 202115 | 4 | 202246 | 8 | 202423 | 25 | 202590 | 74 |
| 201892 | 203 | 202116 | 4 | 202247 | 8 | 202426 | 40 | 202591 | 74 |
| 201895 | 188 | 202117 | 4 | 202248 | 36 | 202427 | 40 | 202592 | 74 |
| 201896 | 188 | 202118 | 31 | 202249 | 36 | 202428 | 40 | 202593 | 74 |
| 201897 | 188 | 202120 | 31 | 202250 | 33 | 202429 | 40 | 202594 | 74 |
| 201898 | 188 | 202121 | 21 | 202265 | 28 | 202433 | 212 | 202595 | 74 |
| 201899 | 188 | 202122 | 21 | 202266 | 28 | 202434 | 212 | 202596 | 74 |
| 201900 | 188 | 202123 | 21 | 202267 | 28 | 202435 | 212 | 202597 | 74 |
| 201912 | 190 | 202124 | 21 | 202268 | 28 | 202436 | 212 | 202598 | 74 |
| 201913 | 190 | 202126 | 12 | 202269 | 28 | 202437 | 212 | 202599 | 74 |
| 201914 | 190 | 202127 | 12 | 202270 | 28 | 202438 | 212 | 202600 | 74 |
| 201915 | 190 | 202128 | 12 | 202271 | 28 | 202439 | 212 | 202601 | 74 |
| 201916 | 190 | 202129 | 12 | 202272 | 28 | 202440 | 51 | 202602 | 74 |
| 201917 | 190 | 202130 | 12 | 202273 | 28 | 202457 | 15 | 202603 | 74 |
| 201918 | 190 | 202131 | 12 | 202280 | 53 | 202458 | 15 | 202604 | 74 |
| 201919 | 190 | 202132 | 12 | 202301 | 33 | 202459 | 15 | 202605 | 74 |
| 201921 | 86 | 202133 | 12 | 202302 | 33 | 202461 | 6 | 202606 | 74 |
| 201925 | 86 | 202134 | 12 | 202303 | 33 | 202462 | 6 | 202607 | 74 |
| 201937 | 144 | 202136 | 12 | 202305 | 19 | 202463 | 6 | 202608 | 37 |
| 201938 | 144 | 202137 | 12 | 202306 | 159 | 202464 | 6 | 202609 | 37 |
| 201939 | 144 | 202138 | 12 | 202309 | 33 | 202465 | 6 | 202616 | 36 |
| 201940 | 144 | 202139 | 12 | 202311 | 35 | 202466 | 6 | 202618 | 34 |
| 201941 | 144 | 202140 | 12 | 202312 | 25 | 202467 | 6 | 202620 | 36 |
| 201943 | 218 | 202141 | 12 | 202315 | 32 | 202468 | 6 | 202624 | 36 |
| 201997 | 76 | 202142 | 12 | 202316 | 25 | 202469 | 6 | 202626 | 37 |
| 202000 | 55 | 202143 | 12 | 202317 | 25 | 202470 | 6 | 202628 | 36 |
| 202003 | 54 | 202144 | 12 | 202324 | 32 | 202471 | 6 | 202632 | 36 |
| 202004 | 58 | 202145 | 12 | 202329 | 32 | 202472 | 6 | 202634 | 36 |
| 202005 | 31 | 202146 | 12 | 202330 | 32 | 202473 | 6 | 202635 | 36 |
| 202006 | 31 | 202147 | 12 | 202332 | 35 | 202474 | 6 | 202636 | 34 |
| 202008 | 31 | 202150 | 32 | 202333 | 35 | 202475 | 6 | 202637 | 36 |
| 202009 | 7 | 202190 | 28 | 202334 | 35 | 202476 | 6 | 202640 | 34 |
| 202010 | 31 | 202191 | 28 | 202335 | 33 | 202477 | 6 | 202644 | 34 |
| 202012 | 31 | 202193 | 5 | 202336 | 35 | 202478 | 6 | 202645 | 81 |
| 202014 | 31 | 202194 | 5 | 202337 | 35 | 202479 | 6 | 202646 | 81 |
| 202015 | 36 | 202195 | 5 | 202338 | 35 | 202480 | 6 | 202647 | 81 |
| 202016 | 31 | 202196 | 5 | 202339 | 33 | 202481 | 6 | 202648 | 81 |
| 202020 | 31 | 202197 | 5 | 202341 | 24 | 202482 | 6 | 202649 | 81 |
| 202039 | 196 | 202198 | 5 | 202342 | 24 | 202483 | 6 | 202650 | 37 |
| 202041 | 196 | 202201 | 31 | 202343 | 24 | 202484 | 6 | 202651 | 36 |
| 202042 | 196 | 202202 | 31 | 202344 | 24 | 202485 | 6 | 202652 | 36 |
| 202049 | 28 | 202203 | 32 | 202346 | 24 | 202486 | 6 | 202653 | 38 |
| 202051 | 39 | 202205 | 32 | 202347 | 24 | 202500 | 55 | 202655 | 36 |
| 202060 | 30 | 202207 | 33 | 202348 | 24 | 202502 | 57 | 202660 | 15 |
| 202072 | 195 | 202209 | 25 | 202349 | 24 | 202503 | 57 | 202661 | 47 |
| 202084 | 5 | 202210 | 31 | 202350 | 31 | 202504 | 57 | 202662 | 47 |
| 202085 | 5 | 202212 | 31 | 202351 | 24 | 202505 | 57 | 202663 | 47 |
| 202086 | 5 | 202214 | 31 | 202352 | 24 | 202506 | 57 | 202664 | 47 |
| 202087 | 5 | 202219 | 17 | 202354 | 24 | 202507 | 57 | 202665 | 47 |
| 202088 | 5 | 202220 | 31 | 202355 | 24 | 202508 | 57 | 202666 | 47 |
| 202092 | 5 | 202221 | 17 | 202356 | 24 | 202509 | 58 | 202667 | 47 |
| 202093 | 5 | 202223 | 17 | 202357 | 44 | 202510 | 58 | 202668 | 47 |
| 202094 | 5 | 202224 | 17 | 202358 | 25 | 202528 | 22 | 202669 | 47 |
| 202095 | 5 | 202225 | 33 | 202359 | 25 | 202534 | 27 | 202671 | 47 |

INDEX

par référence

| Code GIF | Pages | Code GIF | Pages | Code GIF | Pages | Code GIF | Pages | Code GIF | Pages |
|----------|-------|----------|-------|----------|-------|----------|-------|----------|-------|
| 202672 | 47 | 202882 | 32 | 203169 | 60 | 203488 | 145 | 203914 | 31 |
| 202673 | 47 | 202921 | 36 | 203183 | 62 | 203490 | 75 | 203915 | 31 |
| 202674 | 47 | 202922 | 36 | 203198 | 59 | 203501 | 41 | 203916 | 31 |
| 202675 | 47 | 202923 | 39 | 203225 | 80 | 203502 | 41 | 203917 | 45 |
| 202676 | 47 | 202924 | 39 | 203226 | 80 | 203512 | 22 | 203918 | 43 |
| 202677 | 47 | 202926 | 35 | 203227 | 80 | 203533 | 61 | 203919 | 43 |
| 202680 | 15 | 202927 | 35 | 203228 | 80 | 203534 | 61 | 203923 | 38 |
| 202681 | 47 | 202928 | 35 | 203229 | 80 | 203535 | 61 | 203924 | 38 |
| 202682 | 47 | 202929 | 27 | 203230 | 80 | 203567 | 93 | 203925 | 44 |
| 202683 | 47 | 202961 | 8 | 203231 | 80 | 203568 | 93 | 203927 | 44 |
| 202684 | 47 | 202962 | 8 | 203232 | 80 | 203570 | 93 | 203928 | 44 |
| 202685 | 55 | 202963 | 8 | 203233 | 80 | 203631 | 78 | 203966 | 27 |
| 202686 | 55 | 202964 | 8 | 203234 | 80 | 203632 | 30 | 203967 | 27 |
| 202687 | 55 | 202965 | 8 | 203235 | 80 | 203633 | 30 | 203968 | 27 |
| 202690 | 15 | 202977 | 16 | 203247 | 11 | 203634 | 30 | 203969 | 27 |
| 202691 | 55 | 202978 | 16 | 203248 | 11 | 203635 | 30 | 203970 | 27 |
| 202697 | 86 | 202979 | 16 | 203249 | 11 | 203636 | 32 | 204019 | 67 |
| 202698 | 86 | 202980 | 16 | 203250 | 11 | 203637 | 25 | 204020 | 8 |
| 202702 | 88 | 202981 | 16 | 203251 | 11 | 203638 | 33 | 204021 | 67 |
| 202703 | 88 | 202982 | 21 | 203252 | 11 | 203639 | 33 | 204023 | 51 |
| 202704 | 88 | 202983 | 21 | 203253 | 11 | 203640 | 33 | 204024 | 8 |
| 202705 | 88 | 202984 | 21 | 203254 | 11 | 203641 | 38 | 204025 | 51 |
| 202706 | 88 | 202985 | 21 | 203255 | 11 | 203642 | 38 | 204026 | 51 |
| 202707 | 88 | 202987 | 25 | 203256 | 11 | 203643 | 44 | 204027 | 51 |
| 202710 | 39 | 202988 | 26 | 203257 | 11 | 203667 | 72 | 204028 | 8 |
| 202716 | 7 | 202989 | 34 | 203258 | 11 | 203668 | 72 | 204029 | 51 |
| 202717 | 86 | 202990 | 34 | 203259 | 11 | 203669 | 70 | 204032 | 8 |
| 202731 | 88 | 202991 | 34 | 203260 | 11 | 203671 | 70 | 204064 | 58 |
| 202732 | 88 | 202992 | 34 | 203262 | 26 | 203679 | 50 | 204067 | 89 |
| 202733 | 88 | 202993 | 34 | 203268 | 20 | 203680 | 50 | 204076 | 70 |
| 202734 | 88 | 202994 | 37 | 203269 | 20 | 203681 | 61 | 204093 | 188 |
| 202735 | 88 | 203004 | 19 | 203303 | 219 | 203682 | 52 | 204094 | 188 |
| 202740 | 37 | 203006 | 19 | 203304 | 219 | 203683 | 52 | 204095 | 188 |
| 202741 | 89 | 203013 | 62 | 203305 | 219 | 203688 | 27 | 204096 | 188 |
| 202742 | 89 | 203014 | 62 | 203306 | 219 | 203689 | 27 | 204097 | 188 |
| 202743 | 89 | 203019 | 27 | 203308 | 219 | 203695 | 46 | 204103 | 51 |
| 202744 | 89 | 203020 | 27 | 203311 | 219 | 203696 | 46 | 204105 | 51 |
| 202745 | 89 | 203030 | 77 | 203312 | 219 | 203697 | 46 | 204106 | 67 |
| 202747 | 89 | 203031 | 77 | 203313 | 219 | 203741 | 92 | 204112 | 23 |
| 202748 | 89 | 203032 | 77 | 203314 | 219 | 203744 | 52 | 204113 | 23 |
| 202749 | 89 | 203044 | 77 | 203315 | 219 | 203753 | 28 | 204114 | 54 |
| 202767 | 42 | 203046 | 77 | 203316 | 219 | 203754 | 86 | 204115 | 54 |
| 202768 | 42 | 203047 | 77 | 203318 | 219 | 203799 | 8 | 204116 | 54 |
| 202769 | 42 | 203051 | 77 | 203319 | 219 | 203800 | 8 | 204118 | 56 |
| 202770 | 42 | 203054 | 77 | 203391 | 87 | 203801 | 8 | 204119 | 56 |
| 202771 | 42 | 203056 | 88 | 203413 | 58 | 203802 | 8 | 204120 | 56 |
| 202772 | 42 | 203059 | 62 | 203433 | 58 | 203805 | 20 | 204121 | 56 |
| 202773 | 42 | 203063 | 62 | 203451 | 56 | 203809 | 26 | 204122 | 56 |
| 202774 | 45 | 203064 | 27 | 203452 | 56 | 203813 | 60 | 204123 | 55 |
| 202775 | 70 | 203065 | 27 | 203453 | 56 | 203814 | 60 | 204124 | 55 |
| 202776 | 70 | 203070 | 28 | 203454 | 56 | 203829 | 214 | 204125 | 55 |
| 202777 | 70 | 203071 | 28 | 203455 | 56 | 203831 | 88 | 204126 | 55 |
| 202778 | 70 | 203073 | 29 | 203456 | 56 | 203832 | 88 | 204127 | 55 |
| 202780 | 71 | 203074 | 29 | 203457 | 56 | 203833 | 88 | 204128 | 55 |
| 202781 | 71 | 203075 | 28 | 203458 | 56 | 203834 | 88 | 204129 | 55 |
| 202782 | 71 | 203077 | 25 | 203459 | 56 | 203865 | 214 | 204130 | 55 |
| 202783 | 71 | 203079 | 29 | 203460 | 56 | 203866 | 214 | 204169 | 68 |
| 202784 | 71 | 203081 | 29 | 203468 | 144 | 203876 | 219 | 204170 | 68 |
| 202785 | 71 | 203084 | 28 | 203469 | 144 | 203878 | 219 | 204171 | 68 |
| 202786 | 71 | 203085 | 28 | 203470 | 144 | 203879 | 219 | 204173 | 68 |
| 202787 | 71 | 203086 | 28 | 203471 | 144 | 203881 | 219 | 204174 | 68 |
| 202788 | 71 | 203101 | 50 | 203472 | 144 | 203882 | 219 | 204175 | 68 |
| 202789 | 71 | 203102 | 50 | 203473 | 144 | 203883 | 219 | 204176 | 68 |
| 202790 | 71 | 203103 | 50 | 203479 | 145 | 203885 | 219 | 204178 | 68 |
| 202791 | 8 | 203104 | 50 | 203480 | 145 | 203887 | 219 | 204180 | 68 |
| 202792 | 8 | 203105 | 50 | 203481 | 145 | 203888 | 219 | 204181 | 68 |
| 202793 | 8 | 203106 | 50 | 203482 | 145 | 203889 | 219 | 204227 | 69 |
| 202794 | 8 | 203158 | 63 | 203483 | 145 | 203890 | 219 | 204228 | 69 |
| 202795 | 8 | 203159 | 63 | 203484 | 145 | 203891 | 219 | 204229 | 69 |
| 202796 | 73 | 203160 | 63 | 203485 | 145 | 203893 | 219 | 204230 | 69 |
| 202797 | 73 | 203161 | 63 | 203486 | 145 | 203895 | 219 | 204231 | 69 |
| 202798 | 73 | 203164 | 59 | 203487 | 145 | 203898 | 219 | 204232 | 69 |

| Code GIF | Pages | Code GIF | Pages | Code GIF | Pages | Code GIF | Pages | Code GIF | Pages |
|----------|-------|----------|-------|----------|-------|----------|-------|----------|-------|
| 204233 | 69 | 204517 | 26 | 204615 | 85 | 204687 | 85 | 204767 | 108 |
| 204234 | 69 | 204519 | 34 | 204616 | 85 | 204688 | 85 | 204768 | 108 |
| 204235 | 69 | 204520 | 64 | 204617 | 85 | 204689 | 85 | 204769 | 108 |
| 204236 | 69 | 204521 | 64 | 204618 | 85 | 204690 | 85 | 204770 | 108 |
| 204237 | 69 | 204522 | 65 | 204619 | 85 | 204691 | 85 | 204771 | 108 |
| 204238 | 69 | 204523 | 65 | 204620 | 85 | 204692 | 85 | 204772 | 108 |
| 204239 | 69 | 204524 | 65 | 204621 | 85 | 204693 | 85 | 204773 | 108 |
| 204240 | 69 | 204525 | 65 | 204622 | 85 | 204694 | 85 | 204774 | 108 |
| 204242 | 78 | 204526 | 65 | 204623 | 85 | 204695 | 85 | 204775 | 108 |
| 204243 | 78 | 204527 | 65 | 204624 | 85 | 204696 | 85 | 204776 | 108 |
| 204250 | 89 | 204528 | 65 | 204625 | 85 | 204697 | 85 | 204777 | 108 |
| 204251 | 89 | 204529 | 65 | 204626 | 85 | 204698 | 85 | 204778 | 108 |
| 204252 | 89 | 204530 | 65 | 204627 | 85 | 204699 | 85 | 204779 | 108 |
| 204253 | 89 | 204531 | 65 | 204628 | 85 | 204700 | 85 | 204780 | 108 |
| 204254 | 89 | 204532 | 65 | 204629 | 85 | 204701 | 85 | 204781 | 108 |
| 204255 | 89 | 204533 | 65 | 204630 | 85 | 204702 | 85 | 204782 | 108 |
| 204256 | 88 | 204534 | 65 | 204631 | 85 | 204703 | 85 | 204783 | 108 |
| 204257 | 88 | 204535 | 64 | 204632 | 85 | 204704 | 85 | 204784 | 108 |
| 204258 | 88 | 204536 | 65 | 204633 | 85 | 204705 | 85 | 204785 | 108 |
| 204259 | 88 | 204537 | 65 | 204634 | 85 | 204706 | 85 | 204786 | 108 |
| 204260 | 88 | 204538 | 65 | 204635 | 85 | 204707 | 85 | 204787 | 108 |
| 204261 | 88 | 204539 | 65 | 204636 | 85 | 204708 | 85 | 204788 | 108 |
| 204273 | 87 | 204541 | 66 | 204637 | 85 | 204709 | 85 | 204789 | 108 |
| 204274 | 87 | 204543 | 66 | 204638 | 85 | 204710 | 85 | 204790 | 108 |
| 204275 | 87 | 204545 | 66 | 204639 | 85 | 204711 | 85 | 204791 | 108 |
| 204276 | 87 | 204546 | 66 | 204640 | 85 | 204712 | 89 | 204792 | 108 |
| 204277 | 87 | 204547 | 66 | 204641 | 85 | 204713 | 89 | 204793 | 108 |
| 204278 | 87 | 204548 | 66 | 204642 | 85 | 204716 | 89 | 204794 | 108 |
| 204280 | 87 | 204549 | 66 | 204643 | 85 | 204719 | 89 | 204795 | 108 |
| 204284 | 90 | 204550 | 66 | 204644 | 85 | 204720 | 89 | 204796 | 108 |
| 204285 | 90 | 204557 | 66 | 204645 | 85 | 204725 | 85 | 204797 | 108 |
| 204286 | 90 | 204562 | 72 | 204646 | 85 | 204726 | 85 | 204798 | 108 |
| 204287 | 90 | 204563 | 72 | 204647 | 85 | 204727 | 85 | 204799 | 108 |
| 204288 | 90 | 204564 | 72 | 204648 | 85 | 204728 | 85 | 204800 | 108 |
| 204290 | 91 | 204568 | 41 | 204649 | 85 | 204729 | 85 | 204801 | 108 |
| 204291 | 91 | 204569 | 41 | 204650 | 85 | 204730 | 85 | 204802 | 108 |
| 204292 | 91 | 204570 | 41 | 204651 | 85 | 204731 | 85 | 204803 | 108 |
| 204293 | 91 | 204571 | 41 | 204652 | 85 | 204732 | 85 | 204804 | 108 |
| 204299 | 91 | 204577 | 76 | 204653 | 85 | 204733 | 85 | 204805 | 108 |
| 204300 | 91 | 204578 | 79 | 204654 | 85 | 204734 | 85 | 204806 | 108 |
| 204301 | 91 | 204579 | 79 | 204655 | 85 | 204735 | 85 | 204807 | 108 |
| 204302 | 91 | 204580 | 79 | 204656 | 85 | 204736 | 85 | 204808 | 108 |
| 204303 | 91 | 204581 | 79 | 204657 | 85 | 204737 | 85 | 204809 | 108 |
| 204304 | 91 | 204584 | 77 | 204658 | 85 | 204738 | 85 | 204810 | 108 |
| 204306 | 91 | 204585 | 82 | 204659 | 85 | 204739 | 85 | 204811 | 108 |
| 204307 | 91 | 204586 | 82 | 204660 | 85 | 204740 | 85 | 204812 | 108 |
| 204308 | 91 | 204587 | 82 | 204661 | 85 | 204741 | 85 | 204813 | 108 |
| 204477 | 99 | 204588 | 82 | 204662 | 85 | 204742 | 85 | 204814 | 108 |
| 204478 | 99 | 204589 | 82 | 204663 | 85 | 204743 | 85 | 204815 | 108 |
| 204479 | 99 | 204590 | 82 | 204664 | 85 | 204744 | 85 | 204816 | 108 |
| 204480 | 99 | 204591 | 82 | 204665 | 85 | 204745 | 85 | 204817 | 108 |
| 204481 | 99 | 204592 | 83 | 204666 | 85 | 204746 | 85 | 204818 | 108 |
| 204482 | 99 | 204595 | 83 | 204667 | 85 | 204747 | 85 | 204819 | 108 |
| 204483 | 99 | 204596 | 83 | 204668 | 85 | 204748 | 85 | 204820 | 108 |
| 204496 | 86 | 204597 | 83 | 204669 | 85 | 204749 | 85 | 204821 | 108 |
| 204497 | 18 | 204598 | 83 | 204670 | 85 | 204750 | 85 | 204822 | 108 |
| 204498 | 18 | 204599 | 83 | 204671 | 85 | 204751 | 85 | 204823 | 108 |
| 204499 | 18 | 204600 | 83 | 204672 | 85 | 204752 | 85 | 204824 | 108 |
| 204500 | 18 | 204601 | 83 | 204673 | 85 | 204753 | 85 | 204825 | 108 |
| 204501 | 18 | 204602 | 83 | 204674 | 85 | 204754 | 85 | 204826 | 108 |
| 204502 | 18 | 204603 | 84 | 204675 | 85 | 204755 | 108 | 204827 | 108 |
| 204503 | 18 | 204604 | 84 | 204676 | 85 | 204756 | 108 | 204828 | 108 |
| 204504 | 18 | 204605 | 84 | 204677 | 85 | 204757 | 108 | 204829 | 108 |
| 204506 | 18 | 204606 | 84 | 204678 | 85 | 204758 | 108 | 204830 | 108 |
| 204507 | 18 | 204607 | 84 | 204679 | 85 | 204759 | 108 | 204831 | 108 |
| 204508 | 18 | 204608 | 84 | 204680 | 85 | 204760 | 108 | 204832 | 108 |
| 204509 | 19 | 204609 | 84 | 204681 | 85 | 204761 | 108 | 204833 | 108 |
| 204510 | 20 | 204610 | 84 | 204682 | 85 | 204762 | 108 | 204834 | 108 |
| 204511 | 22 | 204611 | 84 | 204683 | 85 | 204763 | 108 | 204835 | 108 |
| 204512 | 23 | 204612 | 85 | 204684 | 85 | 204764 | 108 | 204836 | 108 |
| 204513 | 23 | 204613 | 85 | 204685 | 85 | 204765 | 108 | 204837 | 108 |
| 204516 | 55 | 204614 | 85 | 204686 | 85 | 204766 | 108 | 204838 | 108 |

INDEX

par référence

| Code GIF | Pages | Code GIF | Pages | Code GIF | Pages | Code GIF | Pages | Code GIF | Pages |
|----------|-------|----------|-------|----------|-------|----------|-------|----------|-------|
| 204839 | 108 | 204967 | 109 | 205184 | 98 | 205448 | 105 | 205560 | 104 |
| 204840 | 108 | 204968 | 109 | 205185 | 98 | 205449 | 105 | 205561 | 104 |
| 204841 | 108 | 204969 | 109 | 205186 | 98 | 205450 | 105 | 205562 | 104 |
| 204842 | 108 | 204970 | 109 | 205187 | 98 | 205451 | 105 | 205563 | 104 |
| 204843 | 108 | 204971 | 109 | 205188 | 98 | 205452 | 105 | 205564 | 104 |
| 204844 | 108 | 204972 | 109 | 205189 | 98 | 205453 | 105 | 205565 | 104 |
| 204845 | 108 | 204973 | 109 | 205190 | 98 | 205454 | 105 | 205566 | 104 |
| 204902 | 109 | 204974 | 109 | 205191 | 98 | 205455 | 105 | 205567 | 104 |
| 204903 | 109 | 204975 | 109 | 205192 | 98 | 205457 | 92 | 205568 | 104 |
| 204904 | 109 | 204976 | 109 | 205270 | 86 | 205469 | 104 | 205569 | 104 |
| 204905 | 109 | 204977 | 109 | 205271 | 65 | 205470 | 104 | 205570 | 104 |
| 204906 | 109 | 204978 | 109 | 205272 | 65 | 205471 | 104 | 205571 | 104 |
| 204907 | 109 | 204987 | 226 | 205273 | 65 | 205472 | 104 | 205572 | 104 |
| 204908 | 109 | 204988 | 226 | 205274 | 65 | 205473 | 104 | 205573 | 104 |
| 204909 | 109 | 204989 | 226 | 205275 | 65 | 205474 | 104 | 205574 | 104 |
| 204910 | 109 | 204990 | 226 | 205276 | 65 | 205475 | 104 | 205575 | 104 |
| 204911 | 109 | 204991 | 226 | 205334 | 226 | 205476 | 104 | 205576 | 104 |
| 204912 | 109 | 204992 | 226 | 205335 | 226 | 205477 | 104 | 205577 | 104 |
| 204913 | 109 | 204993 | 226 | 205336 | 226 | 205478 | 104 | 205578 | 104 |
| 204914 | 109 | 204994 | 226 | 205337 | 226 | 205479 | 104 | 205579 | 104 |
| 204915 | 109 | 204995 | 226 | 205338 | 226 | 205480 | 104 | 205580 | 104 |
| 204916 | 109 | 204996 | 226 | 205339 | 226 | 205481 | 104 | 205581 | 104 |
| 204917 | 109 | 204997 | 226 | 205340 | 226 | 205482 | 104 | 205582 | 104 |
| 204918 | 109 | 204998 | 226 | 205341 | 226 | 205483 | 104 | 205583 | 104 |
| 204919 | 109 | 205027 | 89 | 205342 | 226 | 205484 | 104 | 205584 | 104 |
| 204920 | 109 | 205051 | 91 | 205343 | 226 | 205485 | 104 | 205585 | 104 |
| 204921 | 109 | 205052 | 91 | 205344 | 226 | 205486 | 104 | 205586 | 104 |
| 204922 | 109 | 205053 | 91 | 205345 | 226 | 205487 | 104 | 205587 | 104 |
| 204923 | 109 | 205054 | 91 | 205346 | 226 | 205488 | 104 | 205626 | 107 |
| 204924 | 109 | 205058 | 5 | 205347 | 226 | 205489 | 104 | 205627 | 107 |
| 204925 | 109 | 205059 | 5 | 205348 | 226 | 205490 | 104 | 205628 | 107 |
| 204926 | 109 | 205060 | 5 | 205349 | 226 | 205491 | 104 | 205629 | 107 |
| 204927 | 109 | 205061 | 5 | 205350 | 226 | 205492 | 104 | 205630 | 107 |
| 204928 | 109 | 205062 | 5 | 205351 | 226 | 205493 | 104 | 205631 | 107 |
| 204929 | 109 | 205063 | 5 | 205352 | 226 | 205494 | 104 | 205632 | 107 |
| 204930 | 109 | 205073 | 5 | 205353 | 226 | 205495 | 104 | 205633 | 107 |
| 204931 | 109 | 205074 | 5 | 205354 | 226 | 205496 | 104 | 205634 | 107 |
| 204932 | 109 | 205075 | 5 | 205355 | 226 | 205497 | 104 | 205635 | 107 |
| 204933 | 109 | 205076 | 5 | 205356 | 226 | 205498 | 104 | 205636 | 107 |
| 204934 | 109 | 205081 | 5 | 205357 | 226 | 205499 | 104 | 205637 | 107 |
| 204935 | 109 | 205082 | 5 | 205382 | 96 | 205500 | 104 | 205638 | 107 |
| 204936 | 109 | 205104 | 28 | 205383 | 96 | 205501 | 104 | 205639 | 107 |
| 204937 | 109 | 205105 | 29 | 205384 | 96 | 205502 | 104 | 205640 | 107 |
| 204938 | 109 | 205106 | 29 | 205385 | 96 | 205503 | 104 | 205641 | 107 |
| 204939 | 109 | 205107 | 29 | 205386 | 96 | 205504 | 104 | 205642 | 107 |
| 204940 | 109 | 205108 | 29 | 205387 | 96 | 205505 | 104 | 205643 | 107 |
| 204941 | 109 | 205111 | 34 | 205388 | 96 | 205506 | 104 | 205644 | 107 |
| 204942 | 109 | 205112 | 57 | 205390 | 93 | 205507 | 104 | 205645 | 107 |
| 204943 | 109 | 205119 | 21 | 205391 | 93 | 205508 | 104 | 205646 | 107 |
| 204944 | 109 | 205120 | 21 | 205392 | 93 | 205509 | 104 | 205647 | 107 |
| 204945 | 109 | 205121 | 21 | 205393 | 93 | 205510 | 104 | 205648 | 107 |
| 204946 | 109 | 205122 | 21 | 205394 | 93 | 205511 | 104 | 205649 | 107 |
| 204947 | 109 | 205123 | 21 | 205395 | 93 | 205512 | 104 | 205650 | 107 |
| 204948 | 109 | 205124 | 21 | 205396 | 105 | 205513 | 104 | 205651 | 107 |
| 204949 | 109 | 205125 | 21 | 205397 | 105 | 205514 | 104 | 205652 | 107 |
| 204950 | 109 | 205126 | 21 | 205398 | 105 | 205515 | 104 | 205653 | 107 |
| 204951 | 109 | 205127 | 21 | 205399 | 105 | 205516 | 104 | 205654 | 107 |
| 204952 | 109 | 205128 | 26 | 205400 | 105 | 205517 | 104 | 205655 | 107 |
| 204953 | 109 | 205129 | 26 | 205401 | 105 | 205546 | 104 | 205656 | 108 |
| 204954 | 109 | 205132 | 27 | 205402 | 105 | 205547 | 104 | 205657 | 108 |
| 204955 | 109 | 205133 | 27 | 205410 | 105 | 205548 | 104 | 205658 | 108 |
| 204956 | 109 | 205135 | 29 | 205411 | 105 | 205549 | 104 | 205659 | 108 |
| 204957 | 109 | 205136 | 24 | 205412 | 105 | 205550 | 104 | 205660 | 108 |
| 204958 | 109 | 205138 | 24 | 205413 | 105 | 205551 | 104 | 205661 | 108 |
| 204959 | 109 | 205141 | 29 | 205414 | 105 | 205552 | 104 | 205662 | 108 |
| 204960 | 109 | 205142 | 29 | 205415 | 105 | 205553 | 104 | 205663 | 108 |
| 204961 | 109 | 205143 | 29 | 205416 | 105 | 205554 | 104 | 205664 | 108 |
| 204962 | 109 | 205146 | 28 | 205443 | 105 | 205555 | 104 | 205665 | 108 |
| 204963 | 109 | 205180 | 98 | 205444 | 105 | 205556 | 104 | 205666 | 108 |
| 204964 | 109 | 205181 | 98 | 205445 | 105 | 205557 | 104 | 205667 | 108 |
| 204965 | 109 | 205182 | 98 | 205446 | 105 | 205558 | 104 | 205668 | 108 |
| 204966 | 109 | 205183 | 98 | 205447 | 105 | 205559 | 104 | 205678 | 25 |

| Code GIF | Pages | Code GIF | Pages | Code GIF | Pages | Code GIF | Pages | Code GIF | Pages |
|----------|-------|----------|-------|----------|-------|----------|-------|----------|-------|
| 205679 | 50 | 205772 | 87 | 205860 | 99 | 205933 | 100 | 206005 | 96 |
| 205681 | 51 | 205774 | 25 | 205861 | 99 | 205934 | 100 | 206006 | 96 |
| 205682 | 52 | 205783 | 39 | 205862 | 99 | 205935 | 100 | 206007 | 96 |
| 205683 | 52 | 205784 | 40 | 205863 | 99 | 205936 | 100 | 206014 | 96 |
| 205684 | 52 | 205785 | 40 | 205864 | 99 | 205937 | 100 | 206015 | 96 |
| 205685 | 53 | 205786 | 40 | 205865 | 99 | 205938 | 100 | 206016 | 96 |
| 205686 | 54 | 205787 | 70 | 205866 | 99 | 205939 | 100 | 206017 | 96 |
| 205687 | 54 | 205788 | 70 | 205867 | 99 | 205940 | 100 | 206018 | 96 |
| 205688 | 55 | 205789 | 73 | 205868 | 99 | 205941 | 100 | 206019 | 96 |
| 205689 | 54 | 205790 | 76 | 205869 | 99 | 205942 | 100 | 206020 | 96 |
| 205690 | 57 | 205795 | 79 | 205870 | 99 | 205943 | 100 | 206028 | 23 |
| 205691 | 57 | 205796 | 79 | 205871 | 99 | 205944 | 100 | 206029 | 23 |
| 205692 | 57 | 205798 | 86 | 205872 | 99 | 205945 | 100 | 206030 | 33 |
| 205693 | 57 | 205801 | 94 | 205873 | 99 | 205946 | 100 | 206031 | 33 |
| 205694 | 57 | 205802 | 94 | 205874 | 99 | 205947 | 100 | 206032 | 33 |
| 205695 | 57 | 205803 | 94 | 205875 | 99 | 205948 | 100 | 206033 | 33 |
| 205696 | 57 | 205804 | 94 | 205876 | 99 | 205949 | 100 | 206034 | 54 |
| 205697 | 57 | 205805 | 94 | 205877 | 99 | 205950 | 100 | 206035 | 54 |
| 205698 | 57 | 205806 | 94 | 205878 | 99 | 205951 | 100 | 206036 | 54 |
| 205699 | 57 | 205807 | 94 | 205879 | 99 | 205952 | 100 | 206037 | 57 |
| 205700 | 57 | 205808 | 94 | 205880 | 99 | 205953 | 100 | 206038 | 73 |
| 205701 | 57 | 205809 | 94 | 205881 | 99 | 205954 | 100 | 206039 | 73 |
| 205702 | 58 | 205810 | 94 | 205882 | 99 | 205955 | 100 | 206040 | 45 |
| 205703 | 49 | 205811 | 94 | 205883 | 99 | 205956 | 100 | 206041 | 109 |
| 205704 | 49 | 205812 | 94 | 205884 | 99 | 205957 | 100 | 206042 | 109 |
| 205705 | 49 | 205813 | 94 | 205885 | 99 | 205958 | 100 | 206043 | 109 |
| 205706 | 49 | 205814 | 94 | 205886 | 99 | 205959 | 100 | 206044 | 109 |
| 205709 | 49 | 205815 | 94 | 205887 | 99 | 205960 | 100 | 206045 | 109 |
| 205710 | 49 | 205816 | 94 | 205888 | 99 | 205961 | 100 | 206046 | 109 |
| 205711 | 49 | 205817 | 94 | 205889 | 99 | 205962 | 100 | 206047 | 109 |
| 205712 | 49 | 205818 | 94 | 205890 | 99 | 205963 | 100 | 206048 | 109 |
| 205715 | 49 | 205819 | 94 | 205891 | 99 | 205964 | 100 | 206049 | 109 |
| 205716 | 59 | 205820 | 94 | 205892 | 99 | 205965 | 100 | 206050 | 109 |
| 205717 | 59 | 205821 | 94 | 205893 | 99 | 205966 | 100 | 206051 | 109 |
| 205719 | 59 | 205822 | 94 | 205894 | 99 | 205967 | 100 | 206052 | 109 |
| 205720 | 60 | 205823 | 94 | 205895 | 99 | 205968 | 100 | 206053 | 109 |
| 205721 | 60 | 205824 | 94 | 205896 | 99 | 205969 | 100 | 206060 | 109 |
| 205722 | 62 | 205825 | 94 | 205897 | 99 | 205970 | 100 | 206061 | 109 |
| 205724 | 62 | 205826 | 94 | 205898 | 99 | 205971 | 100 | 206062 | 109 |
| 205725 | 63 | 205827 | 94 | 205899 | 99 | 205972 | 100 | 206063 | 109 |
| 205726 | 64 | 205828 | 94 | 205900 | 99 | 205973 | 100 | 206064 | 109 |
| 205727 | 64 | 205829 | 94 | 205901 | 99 | 205974 | 100 | 206065 | 109 |
| 205728 | 63 | 205830 | 94 | 205902 | 99 | 205975 | 100 | 206066 | 109 |
| 205729 | 63 | 205831 | 94 | 205903 | 99 | 205976 | 100 | 206067 | 109 |
| 205730 | 63 | 205832 | 94 | 205904 | 99 | 205977 | 100 | 206068 | 109 |
| 205731 | 64 | 205833 | 94 | 205905 | 99 | 205978 | 100 | 206069 | 109 |
| 205732 | 64 | 205834 | 94 | 205906 | 99 | 205979 | 100 | 206070 | 109 |
| 205733 | 64 | 205835 | 94 | 205907 | 99 | 205980 | 100 | 206071 | 109 |
| 205734 | 65 | 205836 | 94 | 205908 | 99 | 205981 | 100 | 206072 | 109 |
| 205735 | 65 | 205837 | 94 | 205909 | 99 | 205982 | 100 | 206073 | 109 |
| 205736 | 31 | 205838 | 94 | 205910 | 99 | 205983 | 100 | 206074 | 109 |
| 205737 | 34 | 205839 | 95 | 205911 | 99 | 205984 | 100 | 206075 | 109 |
| 205738 | 40 | 205840 | 95 | 205912 | 99 | 205985 | 100 | 206076 | 109 |
| 205739 | 54 | 205841 | 95 | 205913 | 99 | 205986 | 100 | 206077 | 109 |
| 205740 | 54 | 205842 | 95 | 205914 | 99 | 205987 | 100 | 206078 | 109 |
| 205741 | 65 | 205843 | 95 | 205915 | 99 | 205988 | 100 | 206079 | 109 |
| 205743 | 74 | 205844 | 95 | 205917 | 100 | 205989 | 100 | 206080 | 109 |
| 205744 | 76 | 205845 | 95 | 205918 | 100 | 205990 | 100 | 206081 | 109 |
| 205745 | 76 | 205846 | 95 | 205919 | 100 | 205991 | 100 | 206082 | 109 |
| 205746 | 76 | 205847 | 98 | 205920 | 100 | 205992 | 100 | 206083 | 109 |
| 205747 | 79 | 205848 | 98 | 205921 | 100 | 205993 | 100 | 206084 | 109 |
| 205748 | 83 | 205849 | 98 | 205922 | 100 | 205994 | 100 | 206085 | 109 |
| 205749 | 85 | 205850 | 98 | 205923 | 100 | 205995 | 100 | 206086 | 109 |
| 205750 | 85 | 205851 | 98 | 205924 | 100 | 205996 | 100 | 206087 | 109 |
| 205751 | 86 | 205852 | 98 | 205925 | 100 | 205997 | 100 | 206088 | 109 |
| 205757 | 89 | 205853 | 98 | 205926 | 100 | 205998 | 100 | 206089 | 109 |
| 205759 | 90 | 205854 | 98 | 205927 | 100 | 205999 | 100 | 206090 | 109 |
| 205760 | 91 | 205855 | 98 | 205928 | 100 | 206000 | 100 | 206091 | 109 |
| 205762 | 92 | 205856 | 98 | 205929 | 100 | 206001 | 100 | 206092 | 109 |
| 205763 | 93 | 205857 | 98 | 205930 | 100 | 206002 | 96 | 206093 | 109 |
| 205770 | 87 | 205858 | 98 | 205931 | 100 | 206003 | 96 | 206094 | 109 |
| 205771 | 87 | 205859 | 99 | 205932 | 100 | 206004 | 96 | 206095 | 109 |

INDEX

par référence

| Code GIF | Pages | Code GIF | Pages | Code GIF | Pages | Code GIF | Pages | Code GIF | Pages |
|----------|-------|----------|-------|----------|-------|----------|-------|----------|-------|
| 206096 | 109 | 206197 | 102 | 206682 | 17 | 206755 | 44 | 206827 | 73 |
| 206097 | 109 | 206198 | 102 | 206683 | 17 | 206756 | 45 | 206828 | 73 |
| 206098 | 109 | 206199 | 102 | 206684 | 17 | 206757 | 46 | 206829 | 74 |
| 206099 | 109 | 206400 | 45 | 206685 | 10 | 206758 | 46 | 206830 | 74 |
| 206100 | 109 | 206520 | 45 | 206686 | 10 | 206759 | 48 | 206832 | 75 |
| 206101 | 109 | 206615 | 9 | 206687 | 10 | 206760 | 48 | 206833 | 76 |
| 206102 | 109 | 206616 | 9 | 206688 | 10 | 206761 | 48 | 206834 | 76 |
| 206103 | 93 | 206617 | 9 | 206689 | 10 | 206762 | 48 | 206836 | 77 |
| 206105 | 93 | 206618 | 9 | 206690 | 10 | 206763 | 48 | 206840 | 88 |
| 206106 | 95 | 206619 | 9 | 206691 | 10 | 206764 | 48 | 206841 | 88 |
| 206107 | 95 | 206620 | 9 | 206692 | 10 | 206765 | 48 | 206842 | 88 |
| 206108 | 95 | 206621 | 9 | 206693 | 15 | 206766 | 48 | 206843 | 88 |
| 206109 | 95 | 206622 | 9 | 206694 | 15 | 206767 | 48 | 206844 | 88 |
| 206110 | 95 | 206623 | 9 | 206695 | 16 | 206768 | 48 | 206845 | 89 |
| 206111 | 95 | 206624 | 9 | 206697 | 27 | 206769 | 48 | 206847 | 93 |
| 206112 | 95 | 206625 | 9 | 206698 | 22 | 206770 | 48 | 206848 | 93 |
| 206113 | 94 | 206626 | 9 | 206699 | 23 | 206771 | 48 | 206849 | 93 |
| 206114 | 94 | 206627 | 9 | 206700 | 23 | 206772 | 48 | 206850 | 93 |
| 206115 | 94 | 206628 | 9 | 206701 | 23 | 206773 | 48 | 206851 | 95 |
| 206116 | 94 | 206629 | 9 | 206702 | 25 | 206774 | 48 | 206852 | 95 |
| 206117 | 94 | 206630 | 9 | 206703 | 25 | 206775 | 48 | 206853 | 95 |
| 206118 | 94 | 206631 | 9 | 206704 | 25 | 206776 | 48 | 206854 | 95 |
| 206119 | 94 | 206632 | 9 | 206705 | 26 | 206777 | 48 | 206855 | 95 |
| 206120 | 94 | 206633 | 9 | 206706 | 30 | 206778 | 48 | 206856 | 95 |
| 206149 | 92 | 206634 | 9 | 206707 | 30 | 206779 | 48 | 206857 | 95 |
| 206150 | 92 | 206635 | 9 | 206708 | 30 | 206780 | 48 | 206858 | 98 |
| 206151 | 97 | 206636 | 9 | 206709 | 30 | 206781 | 48 | 206859 | 98 |
| 206152 | 97 | 206637 | 9 | 206710 | 30 | 206782 | 48 | 206860 | 98 |
| 206153 | 97 | 206638 | 9 | 206711 | 31 | 206783 | 48 | 206861 | 98 |
| 206154 | 97 | 206639 | 9 | 206712 | 31 | 206784 | 48 | 206862 | 98 |
| 206155 | 97 | 206640 | 9 | 206713 | 31 | 206785 | 48 | 206863 | 98 |
| 206156 | 97 | 206641 | 9 | 206714 | 31 | 206786 | 48 | 206864 | 98 |
| 206157 | 97 | 206642 | 9 | 206715 | 31 | 206787 | 48 | 206865 | 98 |
| 206158 | 97 | 206643 | 9 | 206716 | 31 | 206788 | 48 | 206866 | 98 |
| 206159 | 97 | 206644 | 9 | 206717 | 31 | 206789 | 48 | 206867 | 98 |
| 206160 | 97 | 206645 | 9 | 206718 | 31 | 206790 | 52 | 206868 | 99 |
| 206161 | 97 | 206646 | 9 | 206719 | 31 | 206791 | 52 | 206869 | 99 |
| 206162 | 97 | 206647 | 9 | 206720 | 31 | 206792 | 53 | 206870 | 99 |
| 206163 | 97 | 206648 | 9 | 206721 | 31 | 206793 | 53 | 206871 | 99 |
| 206164 | 97 | 206649 | 9 | 206722 | 31 | 206794 | 53 | 206872 | 99 |
| 206165 | 97 | 206650 | 12 | 206723 | 31 | 206795 | 53 | 206873 | 99 |
| 206166 | 97 | 206651 | 13 | 206724 | 31 | 206796 | 53 | 206874 | 96 |
| 206167 | 97 | 206652 | 11 | 206725 | 31 | 206797 | 53 | 206875 | 96 |
| 206168 | 97 | 206653 | 11 | 206726 | 32 | 206798 | 53 | 206876 | 96 |
| 206169 | 97 | 206654 | 14 | 206727 | 32 | 206799 | 53 | 206877 | 96 |
| 206170 | 97 | 206655 | 14 | 206728 | 33 | 206800 | 56 | 206878 | 96 |
| 206171 | 97 | 206656 | 14 | 206729 | 33 | 206801 | 56 | 206879 | 96 |
| 206172 | 97 | 206657 | 14 | 206730 | 33 | 206802 | 56 | 206880 | 96 |
| 206173 | 97 | 206658 | 14 | 206731 | 33 | 206803 | 56 | 206881 | 96 |
| 206174 | 97 | 206659 | 14 | 206732 | 34 | 206804 | 56 | 206882 | 96 |
| 206175 | 97 | 206660 | 14 | 206733 | 34 | 206805 | 56 | 206883 | 96 |
| 206176 | 97 | 206661 | 14 | 206734 | 34 | 206806 | 57 | 206884 | 96 |
| 206177 | 97 | 206662 | 14 | 206735 | 35 | 206807 | 57 | 206885 | 96 |
| 206178 | 97 | 206663 | 14 | 206736 | 35 | 206808 | 57 | 206886 | 96 |
| 206179 | 97 | 206664 | 14 | 206737 | 35 | 206809 | 60 | 206887 | 96 |
| 206180 | 97 | 206665 | 14 | 206738 | 35 | 206810 | 60 | 206888 | 98 |
| 206181 | 97 | 206666 | 14 | 206739 | 38 | 206811 | 61 | 206889 | 98 |
| 206182 | 97 | 206667 | 14 | 206740 | 37 | 206812 | 63 | 206890 | 98 |
| 206183 | 97 | 206668 | 14 | 206741 | 38 | 206813 | 64 | 206891 | 98 |
| 206184 | 97 | 206669 | 14 | 206742 | 38 | 206814 | 64 | 206892 | 98 |
| 206185 | 97 | 206670 | 15 | 206743 | 39 | 206815 | 64 | 206893 | 98 |
| 206186 | 102 | 206671 | 15 | 206744 | 41 | 206816 | 64 | 206894 | 98 |
| 206187 | 102 | 206672 | 15 | 206745 | 41 | 206817 | 65 | 206895 | 98 |
| 206188 | 102 | 206673 | 15 | 206746 | 42 | 206818 | 65 | 206896 | 98 |
| 206189 | 102 | 206674 | 15 | 206747 | 42 | 206819 | 62 | 206897 | 98 |
| 206190 | 102 | 206675 | 17 | 206748 | 42 | 206820 | 62 | 206898 | 98 |
| 206191 | 102 | 206676 | 17 | 206749 | 43 | 206821 | 70 | 206899 | 98 |
| 206192 | 102 | 206677 | 17 | 206750 | 43 | 206822 | 70 | 206900 | 98 |
| 206193 | 102 | 206678 | 17 | 206751 | 43 | 206823 | 70 | 206901 | 101 |
| 206194 | 102 | 206679 | 17 | 206752 | 43 | 206824 | 73 | 206902 | 101 |
| 206195 | 102 | 206680 | 17 | 206753 | 43 | 206825 | 73 | 206903 | 101 |
| 206196 | 102 | 206681 | 17 | 206754 | 43 | 206826 | 73 | 206904 | 101 |

| Code GIF | Pages | Code GIF | Pages | Code GIF | Pages | Code GIF | Pages | Code GIF | Pages |
|----------|-------|----------|-------|----------|-------|----------|-------|----------|-------|
| 206905 | 101 | 210767 | 101 | 210951 | 226 | 216153 | 45 | 229803 | 45 |
| 206906 | 101 | 210768 | 101 | 210952 | 226 | 216160 | 45 | 230016 | 89 |
| 206907 | 101 | 210769 | 104 | 210953 | 226 | 219609 | 56 | 230101 | 88 |
| 206908 | 108 | 210770 | 104 | 210954 | 226 | 219610 | 56 | 230102 | 88 |
| 206909 | 108 | 210771 | 104 | 210955 | 226 | 219611 | 56 | 230103 | 88 |
| 206910 | 108 | 210772 | 104 | 210956 | 226 | 219618 | 56 | 230104 | 88 |
| 206911 | 108 | 210773 | 104 | 210957 | 226 | 220311 | 4 | 230105 | 88 |
| 206912 | 108 | 210774 | 104 | 210958 | 226 | 221101 | 48 | 232053 | 45 |
| 206913 | 108 | 210775 | 104 | 210959 | 226 | 221103 | 48 | 232153 | 45 |
| 206914 | 108 | 210776 | 104 | 210960 | 226 | 221104 | 48 | 232350 | 22 |
| 206915 | 108 | 210777 | 104 | 210961 | 226 | 221105 | 48 | 235024 | 44 |
| 206916 | 108 | 210778 | 104 | 210962 | 226 | 221106 | 48 | 235028 | 44 |
| 206917 | 108 | 210779 | 104 | 210963 | 226 | 221110 | 48 | 235032 | 44 |
| 206918 | 108 | 210780 | 104 | 210964 | 226 | 221111 | 48 | 235036 | 44 |
| 206919 | 108 | 210781 | 104 | 210965 | 226 | 221112 | 48 | 235040 | 44 |
| 206920 | 108 | 210782 | 104 | 210966 | 226 | 221115 | 48 | 236060 | 45 |
| 206921 | 108 | 210797 | 104 | 210967 | 226 | 221117 | 48 | 236160 | 45 |
| 206922 | 108 | 210798 | 104 | 210968 | 226 | 221118 | 48 | 236260 | 45 |
| 206923 | 108 | 210799 | 104 | 210969 | 226 | 221120 | 48 | 236360 | 45 |
| 206924 | 108 | 210800 | 104 | 210970 | 226 | 221201 | 48 | 237020 | 55 |
| 206925 | 108 | 210801 | 104 | 210971 | 226 | 221202 | 48 | 237021 | 55 |
| 206926 | 108 | 210802 | 104 | 210972 | 226 | 221204 | 48 | 240090 | 33 |
| 206927 | 108 | 210803 | 104 | 210973 | 226 | 221206 | 48 | 240120 | 33 |
| 206928 | 108 | 210818 | 107 | 210974 | 226 | 221210 | 48 | 240841 | 47 |
| 206929 | 108 | 210819 | 107 | 210975 | 226 | 221215 | 48 | 240842 | 47 |
| 206930 | 108 | 210820 | 107 | 210976 | 226 | 221220 | 48 | 240843 | 47 |
| 206931 | 108 | 210821 | 107 | 210989 | 103 | 221301 | 48 | 240844 | 47 |
| 206932 | 108 | 210822 | 107 | 210990 | 103 | 221303 | 48 | 240845 | 47 |
| 206933 | 108 | 210823 | 107 | 210991 | 103 | 221304 | 48 | 240846 | 47 |
| 206934 | 109 | 210824 | 107 | 210992 | 103 | 221306 | 48 | 240847 | 47 |
| 206935 | 109 | 210825 | 107 | 210993 | 103 | 221310 | 48 | 240848 | 47 |
| 206936 | 109 | 210826 | 107 | 210994 | 103 | 221315 | 48 | 240849 | 47 |
| 206937 | 109 | 210827 | 107 | 210995 | 106 | 221320 | 48 | 240850 | 47 |
| 206938 | 109 | 210828 | 107 | 210996 | 106 | 221401 | 48 | 240851 | 47 |
| 206939 | 109 | 210829 | 107 | 210997 | 106 | 221403 | 48 | 240852 | 47 |
| 206940 | 109 | 210830 | 107 | 210998 | 106 | 221406 | 48 | 240853 | 47 |
| 206941 | 109 | 210831 | 107 | 210999 | 106 | 221410 | 48 | 240854 | 47 |
| 206942 | 109 | 210846 | 107 | 211000 | 106 | 221415 | 48 | 240855 | 47 |
| 206943 | 109 | 210847 | 107 | 211001 | 106 | 221420 | 48 | 240856 | 47 |
| 206946 | 62 | 210848 | 107 | 212208 | 31 | 221601 | 48 | 240857 | 47 |
| 206947 | 63 | 210849 | 107 | 212335 | 32 | 221606 | 48 | 240858 | 47 |
| 206948 | 79 | 210850 | 107 | 212340 | 32 | 221610 | 48 | 246362 | 188 |
| 206949 | 79 | 210851 | 107 | 212426 | 106 | 221615 | 48 | 249016 | 34 |
| 206950 | 83 | 210852 | 107 | 212427 | 106 | 221620 | 48 | 249020 | 34 |
| 206951 | 89 | 210860 | 107 | 212428 | 106 | 221901 | 48 | 250001 | 81 |
| 206952 | 89 | 210861 | 107 | 212429 | 106 | 221906 | 48 | 250002 | 80 |
| 210734 | 102 | 210862 | 107 | 212430 | 106 | 221910 | 48 | 250003 | 80 |
| 210735 | 102 | 210863 | 107 | 212431 | 106 | 222102 | 48 | 250005 | 80 |
| 210736 | 102 | 210864 | 107 | 212432 | 106 | 222104 | 48 | 250006 | 80 |
| 210737 | 102 | 210865 | 107 | 212433 | 106 | 222106 | 48 | 250007 | 81 |
| 210738 | 102 | 210866 | 107 | 212434 | 106 | 222110 | 48 | 250011 | 81 |
| 210739 | 102 | 210895 | 107 | 212435 | 106 | 222115 | 48 | 250012 | 81 |
| 210740 | 102 | 210896 | 107 | 212436 | 106 | 222120 | 48 | 250013 | 81 |
| 210741 | 102 | 210897 | 107 | 212437 | 106 | 222301 | 48 | 254121 | 57 |
| 210742 | 102 | 210898 | 107 | 212620 | 34 | 222303 | 48 | 254221 | 57 |
| 210743 | 102 | 210899 | 107 | 212621 | 40 | 222306 | 48 | 254321 | 57 |
| 210744 | 102 | 210900 | 107 | 212624 | 34 | 222315 | 48 | 254421 | 57 |
| 210745 | 102 | 210901 | 107 | 212626 | 34 | 222320 | 48 | 254521 | 57 |
| 210746 | 102 | 210902 | 107 | 212632 | 34 | 223010 | 40 | 256012 | 49 |
| 210747 | 102 | 210903 | 107 | 212720 | 37 | 223020 | 40 | 256013 | 49 |
| 210755 | 101 | 210904 | 107 | 212730 | 37 | 223030 | 40 | 256018 | 49 |
| 210756 | 101 | 210905 | 107 | 212740 | 37 | 223040 | 40 | 256035 | 49 |
| 210757 | 101 | 210906 | 107 | 213020 | 36 | 223050 | 40 | 256040 | 49 |
| 210758 | 101 | 210907 | 107 | 213025 | 36 | 223224 | 34 | 256050 | 49 |
| 210759 | 101 | 210908 | 107 | 213030 | 36 | 223228 | 34 | 256060 | 49 |
| 210760 | 101 | 210923 | 107 | 213035 | 36 | 224030 | 39 | 256070 | 49 |
| 210761 | 101 | 210924 | 107 | 213040 | 36 | 224034 | 39 | 256075 | 49 |
| 210762 | 101 | 210925 | 107 | 213540 | 7 | 224110 | 39 | 256080 | 49 |
| 210763 | 101 | 210926 | 107 | 213550 | 7 | 224120 | 39 | 256502 | 49 |
| 210764 | 101 | 210927 | 107 | 213608 | 44 | 229549 | 75 | 256510 | 41 |
| 210765 | 101 | 210928 | 107 | 214012 | 13 | 229550 | 75 | 256519 | 43 |
| 210766 | 101 | 210929 | 107 | 214014 | 13 | 229801 | 45 | 256520 | 41 |

INDEX

par référence

| Code GIF | Pages | Code GIF | Pages | Code GIF | Pages | Code GIF | Pages | Code GIF | Pages |
|----------|-------|----------|-------|----------|-------|----------|-------|----------|-------|
| 256521 | 43 | 280035 | 38 | 299507 | 190 | 364142 | 106 | 364780 | 102 |
| 256522 | 43 | 280040 | 38 | 299509 | 190 | 364143 | 106 | 364781 | 102 |
| 258805 | 38 | 280045 | 38 | 299511 | 190 | 364144 | 106 | 364782 | 102 |
| 258810 | 38 | 280050 | 38 | 299512 | 190 | 364145 | 106 | 364816 | 102 |
| 260011 | 65 | 280060 | 38 | 299513 | 190 | 364146 | 106 | 364817 | 102 |
| 260112 | 54 | 280080 | 24 | 299514 | 190 | 364147 | 106 | 364818 | 102 |
| 260116 | 65 | 281010 | 32 | 299515 | 190 | 364148 | 106 | 364819 | 102 |
| 260117 | 63 | 282020 | 15 | 299516 | 190 | 364149 | 106 | 364820 | 102 |
| 260151 | 57 | 282483 | 41 | 299609 | 218 | 364150 | 106 | 364821 | 102 |
| 260201 | 59 | 282484 | 41 | 299612 | 218 | 364151 | 106 | 364822 | 102 |
| 260216 | 59 | 282485 | 41 | 299614 | 218 | 364155 | 99 | 364832 | 95 |
| 260237 | 59 | 282487 | 41 | 299649 | 214 | 364156 | 99 | 364833 | 95 |
| 260241 | 57 | 282488 | 66 | 299650 | 214 | 364482 | 99 | 364834 | 95 |
| 260341 | 57 | 282489 | 66 | 299652 | 214 | 364483 | 99 | 364835 | 95 |
| 260405 | 60 | 282490 | 66 | 299654 | 214 | 364484 | 99 | 364836 | 95 |
| 260410 | 60 | 282491 | 66 | 299707 | 20 | 364485 | 99 | 364837 | 95 |
| 260420 | 60 | 290006 | 39 | 299708 | 20 | 364486 | 99 | 364838 | 95 |
| 260523 | 54 | 290008 | 40 | 299732 | 26 | 364487 | 99 | 364839 | 95 |
| 260819 | 54 | 290010 | 40 | 299733 | 26 | 364488 | 99 | 364840 | 95 |
| 260835 | 54 | 290012 | 40 | 299736 | 25 | 364489 | 99 | 364841 | 95 |
| 260850 | 54 | 290140 | 39 | 299754 | 41 | 364490 | 99 | 364842 | 95 |
| 260875 | 54 | 290151 | 39 | 299755 | 41 | 364491 | 99 | 364843 | 95 |
| 261139 | 63 | 290210 | 42 | 299756 | 41 | 364492 | 99 | 364844 | 95 |
| 263000 | 203 | 290212 | 42 | 299757 | 55 | 364493 | 99 | 364845 | 95 |
| 264510 | 40 | 290216 | 42 | 299779 | 37 | 364540 | 102 | 364846 | 95 |
| 264630 | 188 | 290220 | 42 | 299805 | 44 | 364541 | 102 | 364847 | 95 |
| 264632 | 188 | 290224 | 42 | 299806 | 44 | 364542 | 102 | 364856 | 93 |
| 264633 | 188 | 290228 | 42 | 299807 | 44 | 364543 | 102 | 364858 | 93 |
| 264645 | 203 | 290232 | 42 | 299808 | 44 | 364544 | 102 | 364859 | 102 |
| 264710 | 40 | 290324 | 40 | 299900 | 39 | 364545 | 102 | 364860 | 102 |
| 266001 | 76 | 290328 | 40 | 299916 | 190 | 364546 | 102 | 364861 | 102 |
| 266002 | 76 | 290332 | 40 | 299917 | 190 | 364596 | 225 | 364862 | 102 |
| 266004 | 76 | 290424 | 40 | 300143 | 193 | 364697 | 197 | 364863 | 102 |
| 270001 | 218 | 290428 | 40 | 300324 | 193 | 364721 | 93 | 364864 | 102 |
| 270003 | 79 | 290432 | 40 | 300325 | 193 | 364722 | 93 | 364865 | 102 |
| 270011 | 218 | 290520 | 39 | 300350 | 193 | 364723 | 93 | 364866 | 102 |
| 270300 | 79 | 290524 | 39 | 300483 | 225 | 364724 | 93 | 364867 | 102 |
| 271000 | 78 | 290528 | 39 | 300484 | 225 | 364748 | 102 | 364868 | 102 |
| 272012 | 67 | 290532 | 39 | 300485 | 225 | 364749 | 102 | 364869 | 102 |
| 272025 | 67 | 290626 | 39 | 300487 | 225 | 364750 | 102 | 364870 | 102 |
| 272037 | 67 | 290628 | 39 | 300532 | 197 | 364751 | 102 | 364871 | 102 |
| 272050 | 67 | 290630 | 39 | 300533 | 197 | 364752 | 102 | 364872 | 102 |
| 272075 | 67 | 290640 | 39 | 301343 | 194 | 364753 | 102 | 364887 | 103 |
| 272100 | 67 | 290724 | 39 | 301396 | 197 | 364754 | 102 | 364888 | 103 |
| 272500 | 67 | 290726 | 39 | 301508 | 93 | 364755 | 102 | 364889 | 103 |
| 272501 | 67 | 294016 | 42 | 302170 | 92 | 364756 | 102 | 364890 | 103 |
| 272502 | 67 | 294020 | 42 | 302523 | 90 | 364757 | 102 | 364891 | 103 |
| 272503 | 67 | 294024 | 42 | 302524 | 90 | 364758 | 102 | 364892 | 103 |
| 272510 | 67 | 298905 | 42 | 302525 | 91 | 364759 | 102 | 364893 | 103 |
| 272511 | 67 | 298907 | 42 | 302527 | 91 | 364760 | 102 | 364894 | 103 |
| 273321 | 218 | 298908 | 42 | 302528 | 91 | 364761 | 102 | 364895 | 103 |
| 273331 | 218 | 298910 | 42 | 302529 | 91 | 364762 | 102 | 364896 | 103 |
| 274201 | 218 | 298912 | 42 | 302530 | 91 | 364763 | 102 | 364897 | 103 |
| 274204 | 218 | 298916 | 42 | 302531 | 91 | 364764 | 102 | 364898 | 103 |
| 274206 | 218 | 298920 | 42 | 302534 | 91 | 364765 | 102 | 364899 | 103 |
| 275600 | 23 | 298924 | 42 | 312041 | 193 | 364766 | 102 | 364900 | 103 |
| 277111 | 218 | 298926 | 42 | 319600 | 93 | 364767 | 102 | 364901 | 103 |
| 277324 | 115 | 298928 | 42 | 362106 | 199 | 364768 | 102 | 364902 | 103 |
| 277700 | 218 | 299343 | 25 | 362907 | 197 | 364769 | 102 | 364927 | 100 |
| 277701 | 218 | 299352 | 35 | 362908 | 197 | 364770 | 102 | 364928 | 100 |
| 278121 | 218 | 299380 | 48 | 363175 | 92 | 364771 | 102 | 364929 | 100 |
| 278152 | 192 | 299382 | 48 | 363406 | 103 | 364772 | 102 | 364930 | 100 |
| 278153 | 192 | 299478 | 8 | 363407 | 103 | 364773 | 102 | 364931 | 100 |
| 278801 | 218 | 299479 | 8 | 363408 | 103 | 364774 | 102 | 364932 | 100 |
| 279321 | 56 | 299480 | 8 | 363409 | 103 | 364775 | 102 | 364933 | 100 |
| 279421 | 57 | 299481 | 8 | 363410 | 103 | 364776 | 102 | 364934 | 100 |
| 279521 | 56 | 299486 | 92 | 364134 | 92 | 364777 | 102 | | |
| 279621 | 56 | 299487 | 92 | 364140 | 106 | 364778 | 102 | | |
| 279721 | 56 | 299506 | 190 | 364141 | 106 | 364779 | 102 | | |

NOTE



1100 TECHNICIENS,
& COMMERCIAUX



74 ENTREPRISES
conçoivent et installent l'espace de
tous les talents de la restauration.

12 AGENCES

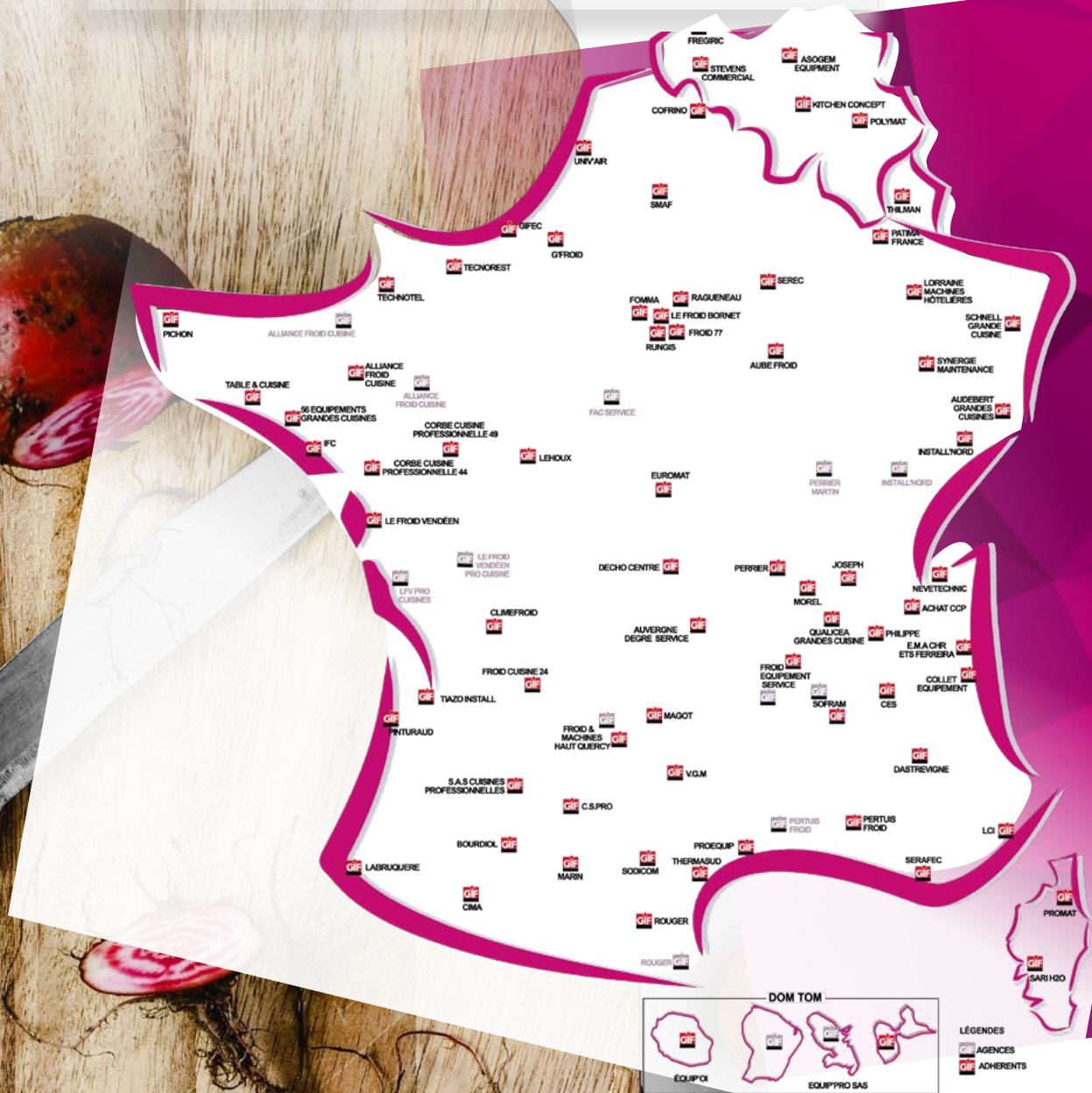



MIN Rungis
2, rue du Caducée
94516 RUNGIS Cedex
Tél. : 01 41 800 882 - Fax : 01 46 866 961
Email : contact@groupegif.com
www.groupegif.com

