

Waukesha Cherry-Burrell®

TWIN SCREW PUMP

Rotary Positive Displacement



SPXFLOW®

ENGINEERED FOR EFFICIENCY AND VERSATILITY



Our WTS pump handles a wide range of substances with ease. Its advanced technology simplifies maintenance, ensuring maximum operational efficiency. Elevate your pumping operations today.



Choose from four sizes to find the perfect fit for your application needs.



The Waukesha Cherry-Burrell Twin Screw (WTS) pump is meticulously designed to handle a diverse range of products with utmost efficiency. From low viscosity substances to highly viscous materials, including volatile or gaseous components, this exceptional pump meets the demands of various applications where hygiene and operational efficiency are paramount.

Dual functionality

Functioning as both a product and Clean-in-Place (CIP) pump, our twin screw pump offers unparalleled versatility. Its cutting-edge technology simplifies the screw replacement process, eliminating the need for re-synchronizing the screw shafts. This hassle-free operation ensures minimal downtime and maximizes productivity.

Ease of maintenance

The pump's cartridge design enhances convenience by enabling swift and effortless seal replacement. With the self-centering flange housing, coupling alignment is easier, eliminating the need for realignment after service work. For additional user convenience, an optional close coupled motor adapter is available.

The WTS pump is available in two versions to cater to industry-specific requirements.

- The 3A authorized version: WTS 70, 104, 130
- The EHEDG certified version: WTS 70, 104, 130, 180

LONG LIFE, ENGINEERED FEATURES

TYPICAL APPLICATIONS



NUTRITION & HEALTH

Soups, Stews, Tomato Paste,
Vegetables, Dressings,
Chocolate, Fats & Oils,
Batters, Cream Fillings,
Brewery, Wort,
Soft/Fruit Drinks,
Meat Processing



DAIRY PROCESSING

Cream, Milk,
Cheese Curd & Whey,
Cottage Cheese,
Yogurt



PHARMACEUTICAL/COSMETICS

Pill Pastes,
Syrups, Extracts, Slurries,
Face Creams & Lotions,
Hair Styling Gels & Liquids,
Dyes & Alcohols,
Soaps & Cosmetics



CHEMICAL/INDUSTRIAL

Solvents, Paints, Fuels,
Resins, Polymers & Sludges,
Oil & Lubricants

Gentle product handling

- Provides gentle and smooth pumping action.
- Pumps large particulates without degradation.

Easy maintenance and servicing

- Simple screw replacement without the need for screw shaft re-synchronization.
- Cartridge design enables quick and easy seal replacement.
- One-sided dismantling is possible to allow for easy cartridge replacement even in limited space.
- Coupling alignment by self-centering flange mounting option available. No need for re-alignment of the coupling after service work, for example.

Wide pressure range

- Operating pressure up to 16 - 25 bar (varies with pump size and design).

Extensive range of applications and viscosity

- Enables higher differential pressure and increased pump capacity through extended screw range (pitch).
- Viscosity of up to 1,000,000 mPas is possible through axial pumping and minimal kneading effect of the product.
- Pumping of the most diverse products with a single pump.

Simultaneous gentle pumping and CIP cleaning

- Incorporates CIP cleaning functionality, eliminating the need for a separate centrifugal pump.
- Yields outstanding results for both Steam in-Place (SIP) and CIP cleaning processes.

Exceptional connection flexibility

- Offers a variety of connector versions to accommodate various needs.

Extended service life

- Shafts designed for long lifespan.

NEW LEVELS OF SANITARY PERFORMANCE



With its high suction capability, the WTS pump is both process and CIP capable, allowing you to reduce the number of pumps, valves and controls in your process.



PRODUCT AND CIP PROCESS

TYPICAL TWIN SCREW CONFIGURATION

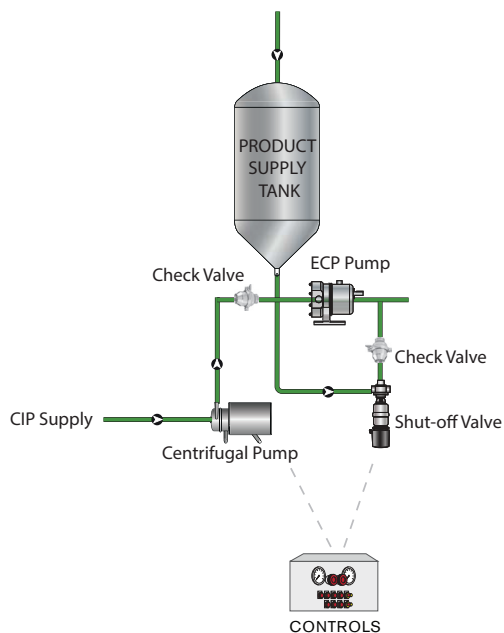

Sanitary Features

- CIP and SIP capability.
- High speed range pumps both product and cleaning fluid.
- High speeds ensure successful self-cleaning in the pump.
- Pushes out product-filled lines, equipment and fittings up to 25 bar pressure.
- Stainless steel gear case as standard.
- Hardened 316 screws; permits running at tighter clearances and pumping a wide range of viscosities.
- Capable of bi-directional flow.

Fast Screw Replacement

- Eliminates screw shaft re-synchronizing during replacement.
- No gear oil draining required for screw replacement.
- Seamless transition to other media.
- Prevention of error sources for enhanced operational reliability.

Efficient Seal Replacement

- Mechanical seal, available pre-assembled as a cartridge, allows for easy replacement.
- Streamlined process eliminates assembly-related errors.
- Enhanced efficiency and ease of maintenance even in confined spaces.

WTS CONFIGURATION

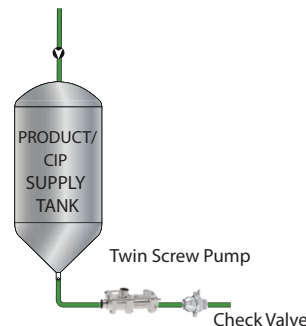

Our twin screw pump is both process and CIP and SIP capable, allowing you to reduce the number of pumps, valves and controls in your process saving capital and running costs.



Choose the right screw pitch for your process

Three screw options for all models offer a wide selection of capacities, pressures, flow rate profiles and particle size. Our pump specialists can advise on optimal pitch for your application.



Options and accessories

Options include heating or cooling jackets, base plate and mobile. Single or double mechanical seals available. Used with flushing fluid to cool, lubricate and flush away residue. Ideal arrangement for severe service applications.

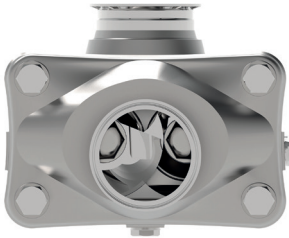

Low pulsation

Axial pumping and slow acceleration in the pump minimizes pulsation, quickly eliminated by high speeds. It exerts minimal shearing forces, preserving product structure and appearance while gently pumping sensitive media. The pump line can be extended by connecting pumps in series, making it suitable for applications demanding exact metering precision.



Versatile design

The pump can handle 60% gas proportion and convey compressible products at high speeds, making it suitable for pumping, emptying, loading and unloading applications.

Contactless pump operation and flushed/blocked mechanical seal eliminate the risk of running dry, allowing reliable operation even with higher gas proportions in the process line.



Ergonomic handling

Integrated handles on pump body provides easy service handling.

ENGINEERED FOR PERFORMANCE AND LONG LIFE

Hardened stainless screws standard; permits running at tighter clearances and pumping wide range of viscosities

Ultra-fast seal replacement with single and dual action seals available fully assembled as a cartridge

Four roller bearings pump bidirectionally; use as a loading and unloading pump

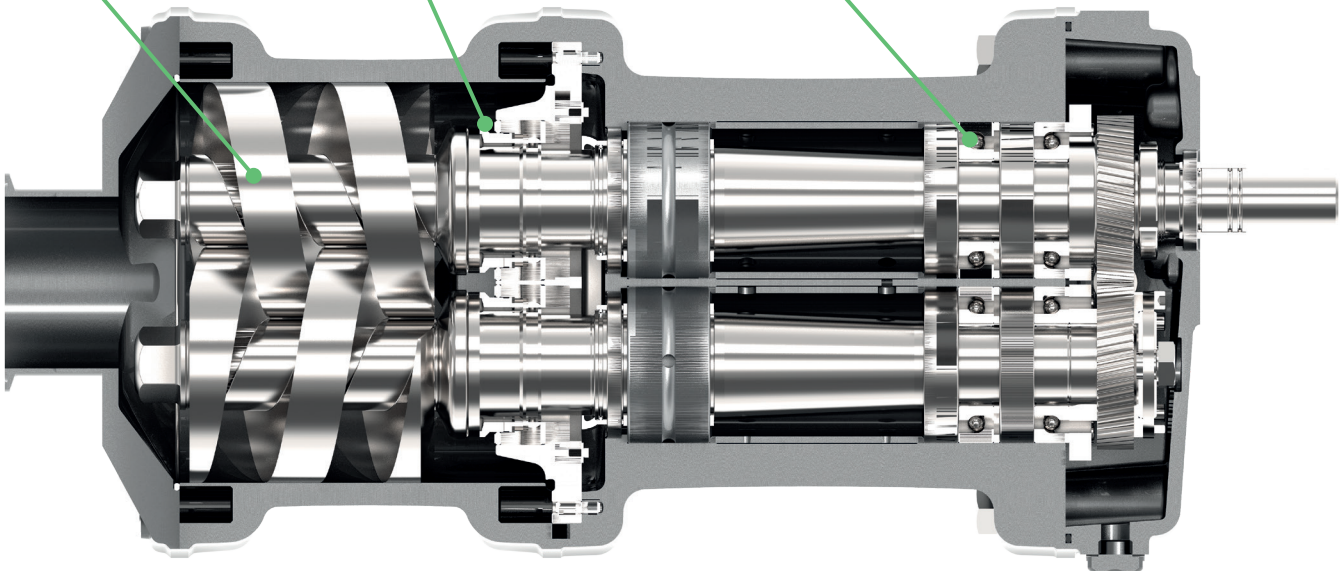

Elastomer choices for O-rings: Fluoroelastomer (FKM), EPDM

*Mechanical seal material options: Silicon Carbide, Tungsten Carbide

Product Specifications

PUMP SIZE	MAX FREE PASSAGE (MM)	MAX PUMP VOLUME AT VISCOSITY OF 1M CP IN GPM (M ³ /H)	MAX RPM	MAXIMUM PEAK PRESSURE (BAR)
WTS 70	20	110 (25)	4,000	30
WTS 104	25	265 (60)	3,600	30
WTS 130	30	440 (100)	3,000	25

WTS 180 information available upon request

Product Dimensions

MODEL		A	B	C	D	E	F	G	H	I	COVER PORT	BODY PORT	WEIGHT
WTS 70	IN	20.45	19.15	13.82	0.78	8.85	8.37	8.66	11.18	2.16	2.5	2.5	132.3 lbs
	MM	519.3	486.3	350.8	Ø 20	227.3	212.6	220	284	55	63.5	63.5	63.5 kg
WTS 104	IN	24.07	22.57	16.51	1.10	6.98	10.05	7.20	13.11	2.48	3	3	199.3 lbs
	MM	611.5	573.5	419.5	Ø 28	177.3	255.24	183	333	63.1	76.2	76.2	90.4 kg
WTS 130	IN	28.50	24.51	18.38	1.37	7.63	11.77	8.20	14.52	3.04	4	4	280 lbs
	MM	724.05	622.55	467.05	Ø 35	193.95	299.2	208.5	369	77.3	63.5	63.5	127 kg

WTS 180 information available upon request

WTS 70

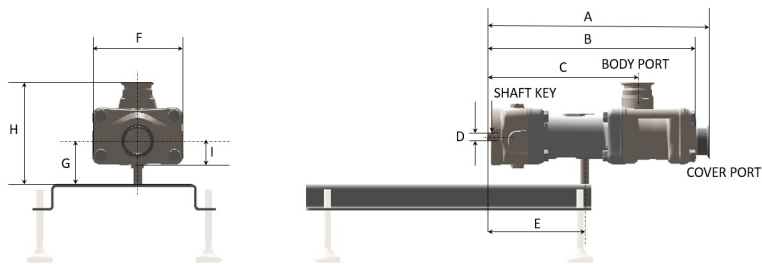

WTS 104

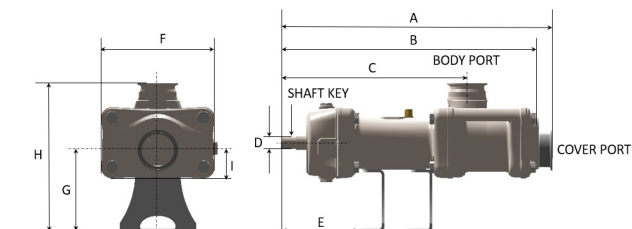

WTS 130

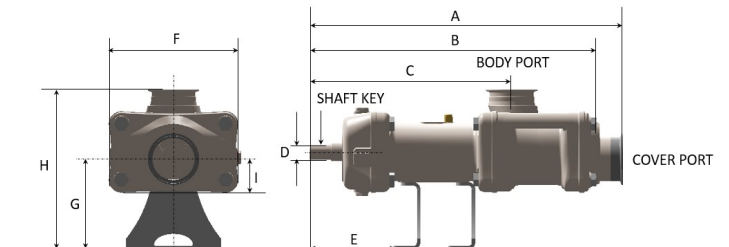

Technical Details:

Maximum pump capacity: 200 m³/h

Viscosity: up to 1,000,000 mPa·s

Maximum temperature: +130°C

Certified to:

ISO 9001 (Quality management)

ISO 14001 (Environmental management)

ISO 45002 (Occupational safety and health protection)

Waukesha Cherry-Burrell®



SPXFLOW®

SPX FLOW, Inc. reserves the right to incorporate our latest design and material changes without notice or obligation. Design features, materials of construction and dimensional data, as described in this bulletin, are provided for your information only and should not be relied upon unless confirmed in writing. Please contact your local sales representative for product availability in your region. The green "X" is a trademark of SPX FLOW, Inc.

For more information, visit www.spxflow.com