



INTERPUMP

FLUID SOLUTIONS 

Powered by I.M.M. Hydraulics

Fittings

2023

Fittings

Standard Tail

N Tail

Interlock Tail

Hyblast / Multispiral Tail

Low Pressure Fittings

Standard Tail





001C



Swaged Ferrule (no skive)

11

002Z



Swaged Ferrule (no skive)

12

012N



Swaged Ferrule

13

0001



Swaged Ferrule (skive)

14

0002



Swaged Ferrule (skive)

15



0009



Swaged Ferrule (skive)

16

004H



Swaged Ferrule (skive)

16

OSI4



Swaged Ferrule (skive)

17

BMC1



Swaged Ferrule (no skive)

17

BMC2



Swaged Ferrule (no skive)

18



0007



Swaged Ferrule (no skive)

18

0008



Swaged Ferrule (no skive)

19



0003



Swaged Ferrule (no skive)

19



PTFE



Ferrule for PTFE hose

20

PTFE-C



Ferrule for PTFE hose

20



0345



BSP Male Flat Seat

21

0060



BSP Female flat seat

22



0350



BSP Male Parallel 60° cone

23

035G



BSP Male Parallel 60° Cone - Rotating

24

0050



BSP Female 60° cone Thrust Wire

25

0051



BSP Female 60° Cone - Rolled Nut

25

0058



BSP Female 60° Cone Slip On Nut

25

0051D



BSP Female 60° Cone - Double Hexagon

26

0150



BSP Swept Elbow 60° Cone-Thrust wire Nut

27

0151



BSP 90° Swept Elbow 60° Cone - Rolled Nut

27

0158



BSP 90° Swept elbow 60° cone Slip On Nut

27

0250



BSP Swept Elbow 60° Cone-Thrust wire Nut

28

0251



BSP 45° Swept Elbow 60° Cone Rolled nut

28

0258



BSP 45° Swept Elbow 60° Cone Slipse on nut

28

2321



BSP 90° Compact Elbow 60° Cone - Rolled nut

29

2300



BSP 90° Compact Elbow 60° Cone - Thrust wire - Welded

29

0041



BSP O'Ring Female 60° Cone-Thrust wire Nut

30

0048



BSP O'Ring Female 60° Cone - Slip on nut

30

0141



BSP O'Ring 90° Swept elbow 60° cone Rolled Nut

31

0148



BSP O'Ring 90° Swept elbow 60° cone- Slip on nut

31

0241



BSP O'Ring 45° Swept Elbow 60° Cone - Rolled nut

32

0248



BSP O'Ring 45° Swept Elbow 60° Cone - Slip on nut

32

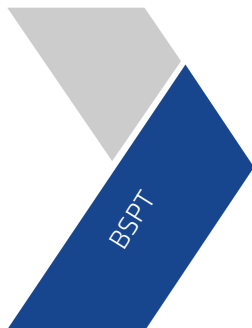

0360



BSP Taper Male 60° cone

33



0370



NPTF Male 60° cone

34

037G



NPTF Male Parallel 60°
Cone - Rotating

35

N051



NPSM Female 60° Cone
Rolled Nut

35



0850



JIC Male 74° cone

36

0900



JIC Female 74° - Thrust
Wire Nut

37

0901



JIC Female 74° cone -
Rolled Nut

37

0902



JIC Female 74° - Slip on
nut

37

0901D



JIC Female 74° Cone-
Double Hexagon

38

0950



JIC 90° Swept Elbow 74°
Cone - Thrust Wire

39

0951



JIC 90° Swept Elbow 74°
cone - Rolled Nut

39

0952



JIC 90° Swept Elbow 74°
cone - Slip on nut

39

1000



JIC 45° Swept Elbow 74°
Cone Thrust Wire Nut

40

1001



JIC 45° Swept Elbow 74°
cone - Rolled Nut

40

1002



JIC 45° Swept Elbow 74°
Cone Slipse on nut

40

095S



JIC 90° Swept Elbow 74°
cone - ISO SHORT

41

2971



JIC 90° Compact Elbow
74° cone - Crimped Nut

41



0385



SAE Male O'R Flat Seat

42



0500



Metric Male 24° Seat Light

43

0085



Metric Female 24° Seat Light

44

0185



90° Metric Swept Elbow 24° Seat Light

45

0285



45° Metric Swept Elbow 24° Seat Light

46



0450



Metric Male 24° Seat Heavy

47

0084



Metric Female 24° Seat Heavy

48

0184



90° Metric Swept Elbow 24° Seat Heavy

49

0284



45° Metric Swept Elbow 24° Seat Heavy

50



0550



Metric Standpipe

51

0650



90° Metric Standpipe

52

0650S



Female Metric Tubular 90° (welded)

52

0750



45° Metric Standpipe

53

0750S



45° Metric Standpipe
(welded)

53



0035



Metric Female 24° Seat
Light Multiseal

54

0135



90° Metric Swept Elbow
24° Seat Light Multiseal

55



0400



Metric Male 60° cone

56

0100



Metric Female 60° cone

57

0200



90° Metric Swept Elbow
60° cone

58



S350



ORFS Male

59

S050



ORFS Female

60

S05T



ORFS Female Back
Hexagon

61

S150



ORFS 90° Swept Elbow

62

S15S



ORFS 90° Swept Elbow -
ISO SHORT

63

S250



ORFS 45° Swept Elbow

64



1260



Straight SAE Flange
3000 PSI

65

1060



90° SAE Flange 3000 PSI

66

1160



45° SAE Flange 3000 PSI

67

FS3L



90° SAE Flange 3000 Psi
- Long Drop

67

S003



Cut Split Flanges - 3000
psi

68



1310



Straight SAE Flange
6000 PSI

69

1110



90° SAE Flange 6000 PSI

70

1210



45° SAE Flange 6000 PSI

71

FS6L



90° SAE Flange 6000 Psi
- Long Drop

71

S006

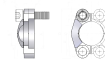

Cut Split Flanges - 6000
psi

72



130S



Straight 'CAT' Flange

72

110S



90° 'CAT' Flange

73

120S



45° 'CAT' Flange

73



1250



Komatsu Flange -
Straight

74

1050



Komatsu Flange 90°

74

1150



Komatsu Flange 45°

74

0940



JIS Female 60° Cone
(Komatsu)

75

0990S



90° JIS Swept Elbow
(Komatsu) - welded

76



0930



JIS Female 60° cone
(Toyota)

76

0980S



90° JIS Swept Elbow
(Toyota) - welded

77



0920



JIS Female 60° cone
(Nissan)

77



0030



Metric Female 24° Cone
French Type

78



FK50



'K' Female

78

FN50



'K' Male (for gun) -
Diameter 10

79

FN51



'K' Male (for gun) -
Diameter 11

79

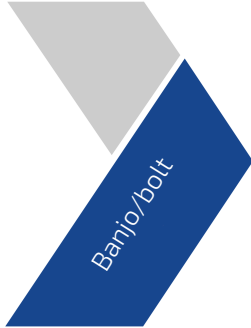

1400



BSP Banjo

80

1600



Double BSP Perforated
Bolt

81

1600-00



BSP Perforated Bolt

81

1350



Metric Banjo

82

1650



Metric perforated bolt

83



D050



Hose Junction

84



GS00



Weldable Fitting

85

001C

Swaged Ferrule (no skive)

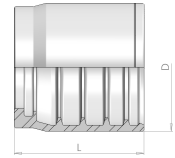

Product number	hose I.D.		Dimension		skive Length	valid for -
	in	mm	D	L		
001C-03	3/16	4,8	18,5	24	NO	R17-2SC-1SN-Pilot-H1
001C-04	1/4	6,4	20	26	NO	R17-2SC-1SC-1SN-Pilot-H1
001C-05	5/16	7,9	22	28	NO	R17-2SC-1SC-1SN-Pilot-H1
001C-06	3/8	9,5	25	28	NO	R17-2SC-1SC-1SN-Pilot-H1
001C-08	1/2	12,7	28	28	NO	R17-2SC-1SC-1SN-Pilot-H1
001C-10	5/8	15,9	32	31	NO	R17-2SC-1SC-1SN-H1
001C-12	3/4	19	36	38	NO	R17-2SC-1SC-1SN-H1
001C-16	1	25,4	44	47,5	NO	R17-2SC-1SC-1SN-H1
001C-20	1.1/4	31,8	54	56	NO	1SN-2SC-1SC
001C-24	1.1/2	38,1	61,6	66	NO	1SN-2SC-1SC
001C-32	2	50,8	75,4	73	NO	1SN-2SC-1SC
001C-40	2.1/2	63,5	88,4	80	NO	2SC-1SC
001C-48	3	76,2	100,5	90	NO	2SC-1SC

0022

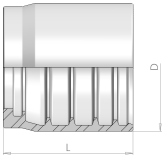

Swaged Ferrule (no skive)

Product number	hose I.D.	I.D.	Dimension		skive	valid for
	in	mm	D	L	Length	-
0022-03	3/16	4.8	21	25.3	NO	25N-(15N)
0022-04	1/4	6.4	22	28	NO	25N-(15N)
0022-05	5/16	7.9	24	28	NO	25N-(15N)
0022-06	3/8	9.5	26	28	NO	25N-(15N)
0022-08	1/2	12.7	30	31	NO	25N-(15N)
0022-10	5/8	15.9	34	31	NO	25N-(15N)
0022-12	3/4	19	38	38.5	NO	25N-(15N)
0022-16	1	25.4	47	48	NO	25N-(15N)
0022-20	1.1/4	31.8	58	56	NO	25N-(15N)
0022-24	1.1/2	38.1	66	66	NO	25N-(15N)
0022-32	2	50.8	79	73	NO	25N-(15N)

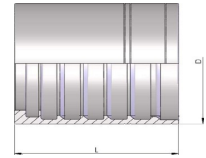
012N**Swaged Ferrule**

Product number	hose I.D.	I.D.	Dimension		skive	valid for
	in	mm	D	L	Length	
012N-04	1/4	6.4	18.3	28	21	ONE 1RN-TWO 2RN-2MC-2SC
012N-05	5/16	7.9	20.0	29	22	ONE 1RN-TWO 2RN-2MC-2SC
012N-06	3/8	9.5	22.8	30	23	ONE 1RN-TWO 2RN-2MC-2SC
012N-08	1/2	12.7	26.3	32	24	ONE 1RN-TWO 2RN-2MC-2SC
012N-10	5/8	15.9	29.8	34	26	ONE 1RN-TWO 2RN-2MC-2SC
012N-12	3/4	19	34.4	40	31	ONE 1RN-TWO 2RN-2MC-2SC
012N-16	1	25.4	42.9	49	38	ONE 1RN-TWO 2RN-2MC-2SC
012N-20	1.1/4	31.8	52.5	56	43	TWO 2RN
012N-24	1.1/2	38.1	59.2	63	49	TWO 2RN
012N-32	2	50.8	72.2	73	58	TWO 2RN

0001

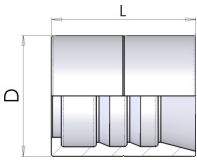

Swaged Ferrule (skive)

Product number	hose I.D.	I.D.	Dimension		skive	valid for
	in	mm	D	L	Length	-
0001-03	3/16	4.8	17.5	27	20	1SN-(2SC-1ST)
0001-04	1/4	6.4	20	30.2	23	1SN-(2SC-1ST)
0001-05	5/16	7.9	22	30.7	23	1SN-(2SC-1ST)
0001-06	3/8	9.5	24	32	24	1SN-(2SC-1ST)
0001-08	1/2	12.7	28.5	34	25	1SN-(2SC-1ST)
0001-10	5/8	15.9	32	37	27	1SN-(2SC-1ST)
0001-12	3/4	19	36	43	31	1SN-(2SC-1ST)
0001-16	1	25.4	43	50	37	1SN-(2SC-1ST)
0001-20	1.1/4	31.8	52	57	46	1SN-(2SC-1ST)
0001-24	1.1/2	38.1	57	63	44	1SN-(2SC-1ST)
0001-32	2	50.8	70.6	78	60	1SN-(2SC-1ST)

0002

Swaged Ferrule (skive)

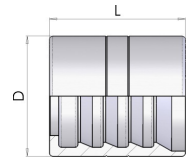

Product number	hose I.D.		I.D.		Dimension		skive	valid for
	in	mm	D	L	Length	-		
0002-03	3/16	4.8	20	27	21	25N-(2ST)		
0002-04	1/4	6.4	21	30	22	25N-(2ST)		
0002-05	5/16	7.9	24	30	22	25N-(2ST)		
0002-06	3/8	9.5	25.4	32	24	25N-3SC-(2ST)		
0002-08	1/2	12.7	30	34	25	25N-(2ST)		
0002-10	5/8	15.9	34	37	27	25N-(2ST)		
0002-12	3/4	19	38	43	31	25N-(2ST)		
0002-16	1	25.4	46	50	37	25N-(2ST)		
0002-20	1.1/4	31.8	56	59	43	25N-(2ST)		
0002-24	1.1/2	38.1	62	63	45	25N-(2ST)		
0002-32	2	50.8	75	79	61	25N-(2ST)		
0002-40	2.1/2	63.5	95	83.7	63	25N-(2ST)		
0002-48	3	76.2	105.6	94.3	78	25N-(2ST)		

0009

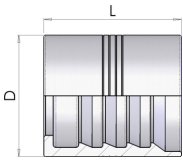

Swaged Ferrule (skive)

Product number	hose I.D.	Dimension		I.D.	skive	valid for
	in	D	mm	L	Length	
0009-04	1/4	21	6.4	30	22	4SP-R12
0009-06	3/8	25.4	9.5	33.5	26	4SP-R12
0009-08	1/2	30	12.7	36	28	4SP-R12
0009-10	5/8	34	15.9	40	31	4SP-R12
0009-12	3/4	38	19	43	34	4SP-(R12-4SH)
0009-16	1	46	25.4	60	48	(4SP-R12)
0009-20	1.1/4	56	31.8	66	54	(4SP-R12)
0009-24	1.1/2	67	38.1	76.5	62	(4SP-R12)
0009-32	2	80	50.8	79.8	64	4SP

004H

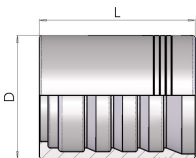

Swaged Ferrule (skive)

Product number	hose I.D.	I.D.	Dimension		skive	valid for
	in	mm	D	L	Length	
004H-20	1.1/4	31.8	52	66	55	(4SH)
004H-24	1.1/2	38.1	62	76.5	63	(4SH)
004H-32	2	50.8	75	79.8	65	R12

OSI4

Swaged Ferrule (skive)

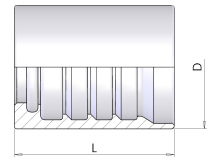

Product number	hose I.D.		I.D.		Dimension		skive	valid for
	in	mm	D	L	Length			
OSI4-06	3/8	9.5	24	31	23		Four SP - Hysoflex 4K - Hysoflex 5K - Hysoflex 6K	
OSI4-08	1/2	12.7	27.6	33	24.5		Four SP - Hysoflex 4K - Hysoflex 5K - Hysoflex 6K	
OSI4-10	5/8	15.9	32	36	27.5		Four SP - Hysoflex 4K	
OSI4-12	3/4	19	36.4	42	32.5		Four SP - Hysoflex 4K	
OSI4-16	1	25.4	44	55.5	44		Four SP - Hysoflex 4K	

BMC1

Swaged Ferrule (no skive)

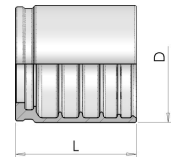

Product number	hose I.D.		I.D.		Dimension		skive	valid for
	in	mm	D	L	Length			
BMC1-12	3/4	19	45	41	NO		R12	
BMC1-16	1	25.4	53.5	56	NO		R12-4SP-4SH	
BMC1-20	1.1/4	31.8	62	62	NO		(4SH)	

BMC2

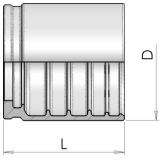

Swaged Ferrule (no skive)

Product number	hose I.D.		I.D.		Dimension		skive	valid for
	in	mm	D	L	Length	-		
BMC2-20	1.1/4	31.8	66	62	NO	R12-4SP		
BMC2-24	1.1/2	38.1	73.3	70	NO	R12-4SP-(R13)		

0007

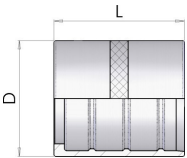

Swaged Ferrule (no skive)

Product number	hose I.D.		I.D.		Dimension		skive	valid for
	in	mm	D	L	Length	-		
0007-03	3/16	4.8	14	27	NO	R7-R6-1TE-2TE		
0007-04	1/4	6.4	17	29	NO	R7-R6-1TE-2TE		
0007-05	5/16	7.9	19	30	NO	R7-R6-1TE-2TE		
0007-06	3/8	9.5	21	31	NO	R7-R6-1TE-2TE		
0007-08	1/2	12.7	25.4	34	NO	R7-R6-1TE-2TE		
0007-10	5/8	15.9	28.5	36	NO	R7-R6-1TE-2TE		
0007-12	3/4	19	32	36	NO	R7-R6-1TE-2TE		
0007-16	1	25.4	40	50	NO	R7-R6-1TE-2TE		

0008

Swaged Ferrule (no skive)

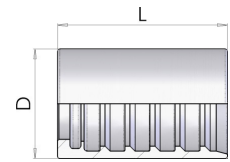

Product number	hose I.D.	I.D.	Dimension		skive	valid for
	in	mm	D	L	Length	-
0008-03	3/16	4.8	13	25	NO	R8
0008-04	1/4	6.4	17	29	NO	R8
0008-05	5/16	7.9	19	30	NO	R8
0008-06	3/8	9.5	21.5	31	NO	R8
0008-08	1/2	12.7	26	34	NO	R8
0008-10	5/8	15.9	29	40	NO	R8
0008-12	3/4	19	32	42	NO	R8
0008-16	1	25.4	40	50	NO	R8

0003

Swaged Ferrule (no skive)

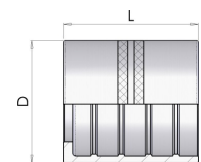

Product number	hose I.D.	I.D.	Dimension		skive	valid for
	in	mm	D	L	Length	-
0003-03	3/16	4.8	14	27	NO	R3-3TE-R5
0003-04	1/4	6.4	19	29	NO	R3-3TE-R5
0003-05	5/16	7.9	22	30	NO	R3-3TE-R5
0003-06	3/8	9.5	24	31	NO	R3-3TE-R5
0003-08	1/2	12.7	28.5	34	NO	R3-3TE-R5
0003-10	5/8	15.9	32	36	NO	R3-3TE-R5
0003-12	3/4	19	38	42	NO	R3-3TE-R5
0003-16	1	25.4	46	50	NO	R3-3TE
0003-20	1.1/4	31.8	52	57	NO	R3-3TE

PTFE

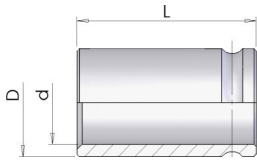

Ferrule for PTFE hose

Product number	hose I.D.	Dimension			I.D.	skive	valid for
	in	D	mm	L	d-int	Length	-
PTFE-03	3/16	12.7	4.8	22	9.5	NO	PTFE type T1
PTFE-04	1/4	14.4	6.4	23.9	11.1	NO	PTFE type T1
PTFE-05	5/16	17.1	7.9	24.6	13	NO	PTFE type T1
PTFE-06	3/8	19	9.5	27.4	15	NO	PTFE type T1
PTFE-08	1/2	22.4	12.7	28.7	18.3	NO	PTFE type T1
PTFE-10	5/8	27	15.9	31.7	23.1	NO	PTFE type T1
PTFE-12	3/4	28.7	19	34.5	24.8	NO	PTFE type T1
PTFE-16	1	38.1	25.4	43.6	34.3	NO	PTFE type T1

For PTFE hose type T1 - (with standard fittings)

PTFE-C

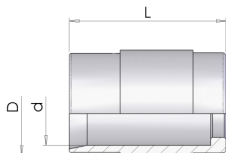

Ferrule for PTFE hose

Product number	hose I.D.	Dimension			I.D.	skive	valid for
	in	D	mm	L	d-int	Length	-
PTFE-04-C	1/4	17.8	6.4	26.5	14.4	NO	PTFE type LTC
PTFE-06-C	3/8	20	9.5	30.5	16.8	NO	PTFE type LTC
PTFE-08-C	1/2	24	12.7	33.2	20.5	NO	PTFE type LTC
PTFE-10-C	5/8	29.2	15.9	34.8	25.4	NO	PTFE type LTC
PTFE-12-C	3/4	31.1	19	40.9	27.4	NO	PTFE type LTC
PTFE-16-C	1	38.5	25.4	47	34.7	NO	PTFE type LTC

For PTFE hose type LTC - (with standard fittings)

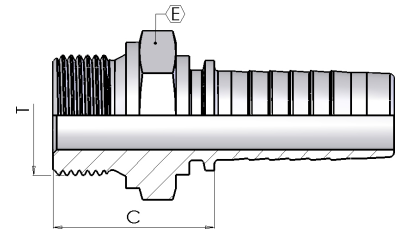
0345**BSP Male - Flat Seat****(AGR-F)**

Product number	hose I.D.	Dimension				I.D.
	in	dash size	mm	T	E	Cut-off C
0345-04-04	1/4	04	6.4	1/4-19	19	27
0345-05-06	5/16	05	7.9	3/8-19	22	28
0345-06-06	3/8	06	9.5	3/8-19	22	29
0345-06-08	3/8	06	9.5	1/2-14	27	32
0345-08-08	1/2	08	12.7	1/2-14	27	33
0345-10-12	5/8	10	15.9	3/4-14	32	35
0345-12-12	3/4	12	19	3/4-14	32	36
0345-12-16	3/4	12	19	1-11	41	39
0345-16-16	1	16	25.4	1-11	41	40

0060

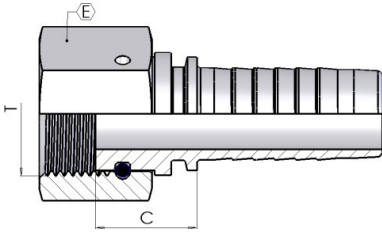

BSP Female flat seat

(DKR-F)

Product number	hose I.D.		I.D.	Dimension		
	in	mm		dash size	T	E
0060-04-04	1/4	6.4	04	1/4-19	19	14
0060-04-06	1/4	6.4	04	3/8-19	22	15
0060-05-06	5/16	7.9	05	3/8-19	22	15
0060-05-08	5/16	7.9	05	1/2-14	27	17
0060-06-06	3/8	9.5	06	3/8-19	22	15
0060-06-08	3/8	9.5	06	1/2-14	27	16
0060-08-08	1/2	12.7	08	1/2-14	27	16
0060-08-12	1/2	12.7	08	3/4-14	32	23
0060-10-10	5/8	15.9	10	5/8-14	30	16
0060-10-12	5/8	15.9	10	3/4-14	32	20
0060-12-12	3/4	19	12	3/4-14	32	21
0060-12-16	3/4	19	12	1-11	38	23
0060-16-16	1	25.4	16	1-11	38	22

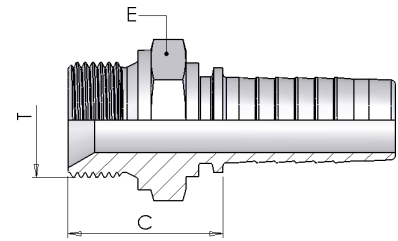
BSP Male Parallel 60° cone**(AGR)**

Product number	hose I.D.		Dimension			I.D.
	in	dash size	mm	T	E	Cut-off C
0350-03-02	3/16	03	4.8	1/8-28	14	21
0350-03-04	3/16	03	4.8	1/4-19	19	26
0350-04-02	1/4	04	6.4	1/8-28	14	21
0350-04-04	1/4	04	6.4	1/4-19	19	27
0350-04-06	1/4	04	6.4	3/8-19	22	28
0350-04-08	1/4	04	6.4	1/2-14	27	35
0350-05-04	5/16	05	7.9	1/4-19	19	27
0350-05-06	5/16	05	7.9	3/8-19	22	28
0350-05-08	5/16	05	7.9	1/2-14	27	32
0350-06-04	3/8	06	9.5	1/4-19	19	27
0350-06-06	3/8	06	9.5	3/8-19	22	29
0350-06-08	3/8	06	9.5	1/2-14	27	32
0350-08-06	1/2	08	12.7	3/8-19	22	29
0350-08-08	1/2	08	12.7	1/2-14	27	33
0350-08-10	1/2	08	12.7	5/8-14	30	34
0350-08-12	1/2	08	12.7	3/4-14	32	35
0350-10-08	5/8	10	15.9	1/2-14	27	33
0350-10-10	5/8	10	15.9	5/8-14	30	35
0350-10-12	5/8	10	15.9	3/4-14	32	35
0350-12-08	3/4	12	19	1/2-14	27	33
0350-12-12	3/4	12	19	3/4-14	32	36
0350-12-16	3/4	12	19	1-11	41	39
0350-16-16	1	16	25.4	1-11	41	40
0350-16-20	1	16	25.4	1.1/4-11	50	44
0350-20-16	1.1/4	20	31.8	1-11	41	41
0350-20-20	1.1/4	20	31.8	1.1/4-11	50	45
0350-20-24	1.1/4	20	31.8	1.1/2-11	55	46
0350-24-24	1.1/2	24	38.1	1.1/2-11	55	46
0350-24-32	1.1/2	24	38.1	2-11	70	54
0350-32-24	2	32	50.8	1.1/2-11	65	50
0350-32-32	2	32	50.8	2-11	70	54

035G

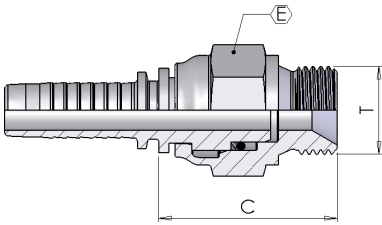

BSP Male Parallel 60° Cone - Rotating

(AGR-RO)

Product number	hose I.D.	I.D.	Dimension			
	in	mm	dash size	T	E	Cut-off C
035G-04-04	1/4	6.4	04	1/4-19	19	37
035G-06-06	3/8	9.5	06	3/8-19	22	43
035G-08-08	1/2	12.7	08	1/2-14	27	47
035G-12-12	3/4	19	12	3/4-14	32	52

0050

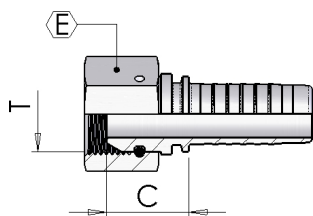

0051

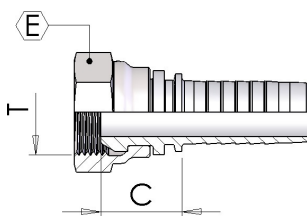

0058

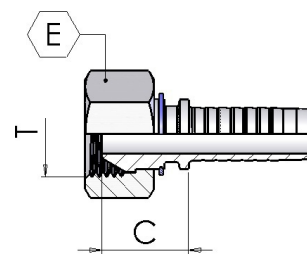

BSP Female 60° Cone

(DKR)

Product number	hose I.D.		Dimension			
	in	mm	dash size	Thread T	hex E	Cut-off C
0051-03-02	3/16	4.8	03	1/8-28	14	15
0058-03-04	3/16	4.8	03	1/4-19	19	17
0051-04-02	1/4	6.4	04	1/8-28	14	15
0058-04-04	1/4	6.4	04	1/4-19	19	21
0058-04-06	1/4	6.4	04	3/8-19	22	21
0051-05-04	5/16	9.5	05	1/4-19	19	19
0058-05-06	5/16	7.9	05	3/8-19	22	21
0058-05-08	5/16	7.9	05	1/2-14	27	22
0051-06-04	3/8	9.5	06	1/4-19	19	17
0058-06-06	3/8	9.5	06	3/8-19	22	21
0058-06-08	3/8	9.5	06	1/2-14	27	23
0051-08-06	1/2	12.7	08	3/8-19	22	20
0058-08-08	1/2	12.7	08	1/2-14	27	23
0051-08-10	1/2	12.7	08	5/8-14	30	20
0051-08-12	1/2	12.7	08	3/4-14	32	27
0051-10-08	5/8	15.9	10	1/2-14	27	23
0051-10-10	5/8	15.9	10	5/8-14	30	20
0051-10-12	5/8	15.9	10	3/4-14	32	25
0051-12-08	3/4	19	12	1/2-14	27	24
0051-12-12	3/4	19	12	3/4-14	32	25
0051-12-16	3/4	19	12	1-11	38	26
0051-16-12	1	25.4	16	3/4-14	32	27
0051-16-16	1	25.4	16	1-11	38	27
0050-16-20	1	25.4	16	1.1/4-11	50	30
0050-20-20	1.1/4	31.8	20	1.1/4-11	50	32
0050-20-24	1.1/4	31.8	20	1.1/2-11	55	34
0050-24-24	1.1/2	38.1	24	1.1/2-11	55	34
0050-24-32	1.1/2	38.1	24	2-11	70	34
0050-32-32	2	50.8	32	2-11	70	31
0050-40-40	2.1/2	63.5	40	2.1/2-11	85	41
0050-48-48	3	76.2	25.8	3-11	100	45

0051D

BSP Female 60° Cone - Double Hexagon

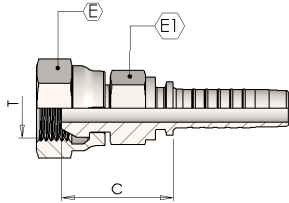

Product number	hose I.D.		Dimension				
	in	mm	dash size	T	E	E1	C
0051D04-04	1/4	6,4	04	1/4-19	19	14	22
0051D06-06	3/8	9,5	06	3/8-19	22	17	28
0051D08-08	1/2	12,7	08	1/2-14	27	22	30
0051D12-12	3/4	19	12	3/4-14	32	27	35

0150

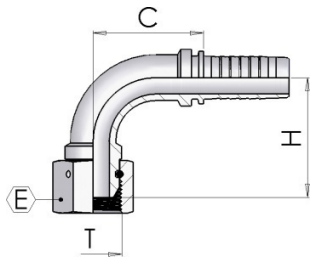

0151

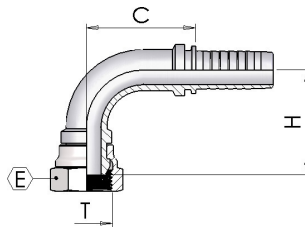

0158

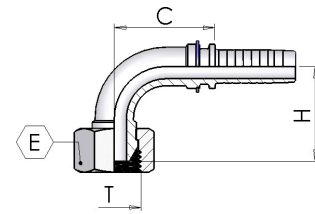

BSP 90° Swept elbow 60° cone

Product number	hose I.D.		Dimension				
	in	mm	dash size	T	E	H	Cut-off C
0151-03-02	3/16	4.8	03	1/8-28	14	23	23
0151-03-04	3/16	4.8	03	1/4-19	19	25	25
0151-04-02	1/4	6.4	04	1/8-28	14	25	25
0158-04-04	1/4	6.4	04	1/4-19	19	21	27
0158-04-06	1/4	6.4	04	3/8-19	22	24	27
0151-05-04	5/16	7.9	05	1/4-19	19	31	31
0158-05-06	5/16	7.9	05	3/8-19	22	29	31
0151-06-04	3/8	9.5	06	1/4-19	19	33	31
0158-06-06	3/8	9.5	06	3/8-19	22	29	33
0158-06-08	3/8	9.5	06	1/2-14	27	31	36
0151-08-06	1/2	12.7	08	3/8-19	22	42	39
0158-08-08	1/2	12.7	08	1/2-14	27	37.5	38.5
0151-08-10	1/2	12.7	08	5/8-14	30	41	40
0151-08-12	1/2	12.7	08	3/4-14	32	46	41
0151-10-10	5/8	15.9	10	5/8-14	30	43	43
0151-10-12	5/8	15.9	10	3/4-14	32	50	45
0151-12-12	3/4	19	12	3/4-14	32	57	56
0151-12-16	3/4	19	12	1-11	38	56	56
0151-16-16	1	25.4	16	1-11	38	67	70
0150-20-20	1.1/4	31.8	20	1.1/4-11	50	84	83
0150-24-24	1.1/2	38.1	24	1.1/2-11	55	95	103
0150-32-32	2	50.8	32	2-11	70	124	133

0250

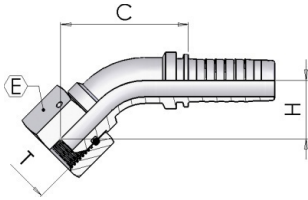

0251

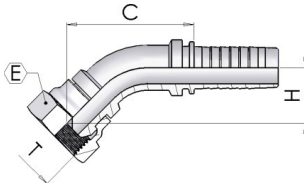

0258

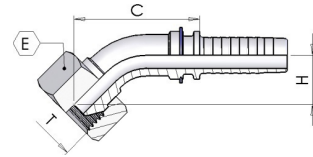

BSP 45° Swept Elbow 60° Cone

(DKR-45°)

Product number	hose I.D.		Dimension				
	in	mm	dash size	T	E	H	C
0251-03-02	3/16	4.8	03	1/8-28	14	15	33
0251-04-02	1/4	6.4	04	1/8-28	14	14	40
0258-04-04	1/4	6.4	04	1/4-19	19	14	39
0258-04-06	1/4	6.4	04	3/8-19	22	16	41
0251-05-04	5/16	7.9	05	1/4-19	19	16	47
0251-06-04	3/8	9.5	06	1/4-19	19	19	50
0258-06-06	3/8	9.5	06	3/8-19	22	17	47
0258-06-08	3/8	9.5	06	1/2-14	27	16	52
0251-08-06	1/2	12.7	08	3/8-19	22	22	63
0258-08-08	1/2	12.7	08	1/2-14	27	19	61
0251-08-10	1/2	12.7	08	5/8-14	30	21	64
0251-08-12	1/2	12.7	08	3/4-14	32	26	67
0251-10-08	5/8	15.9	10	1/2-14	27	24	68
0251-10-10	5/8	15.9	10	5/8-14	30	23	68
0251-10-12	5/8	15.9	10	3/4-14	32	27	72
0251-12-12	3/4	19	12	3/4-14	32	28	88
0251-12-16	3/4	19	12	1-11	38	32	88
0251-16-16	1	25.4	16	1-11	38	30	88
0250-20-20	1.1/4	31.8	20	1.1/4-11	50	40	107
0250-24-24	1.1/2	38.1	24	1.1/2-11	55	51	117
0250-32-32	2	50.8	32	2-11	70	59	146

2321

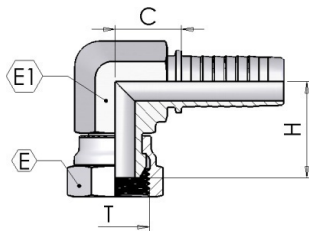

2300

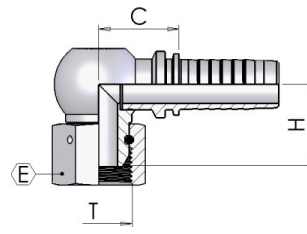

BSP 90° Compact Elbow 60° Cone

Product number	hose I.D.		Dimension					
	in	mm	dash size	T	E	E1	H	C
2321-03-02	3/16	4.8	03	1/8-28	14	12	18	17
2321-03-04	3/16	4.8	03	1/4-19	19	14	20	17
2321-04-04	1/4	6.4	04	1/4-19	19	15	20	19
2321-04-06	1/4	6.4	04	3/8-19	22	17	29	24
2321-05-06	5/16	7.9	05	3/8-19	22	17	23	24
2321-06-06	3/8	9.5	06	3/8-19	22	17	23	23
2321-06-08	3/8	9.5	06	1/2-14	27	19	26	28
2321-08-08	1/2	12.7	08	1/2-14	27	22	27	26
2321-10-10	5/8	15.9	10	5/8-14	30	24	28	29
2321-12-12	3/4	19	12	3/4-14	32	27	32	32
2321-16-16	1	25.4	16	1-11	38	32	36	38
2300-20-20	1.1/4	31.8	20	1.1/4-11	50	-	46	47

0041

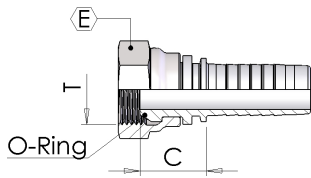

0048

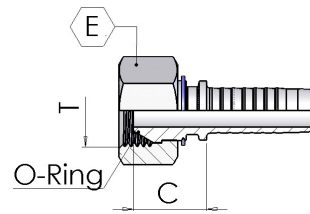

BSP O'Ring Female 60° Cone

(DKR-OR)

Product number	hose I.D.		Dimension			
	in	mm	dash size	Thread T	hex E	Cut-off C
0048-04-04	1/4	6.4	04	1/4-19	19	22
0048-04-06	1/4	6.4	04	3/8-19	22	20
0048-06-06	3/8	9.5	06	3/8-19	22	20
0048-06-08	3/8	9.5	06	1/2-14	27	23
0048-08-08	1/2	12.7	08	1/2-14	27	23
0041-10-10	5/8	15.9	10	5/8-14	30	21
0041-12-12	3/4	19	12	3/4-14	32	26
0041-16-16	1	25.4	16	1-11	38	28

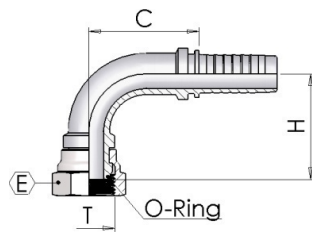
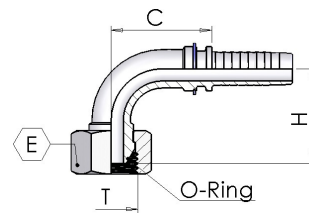
0141**0148**

BSP O'Ring 90° Swept elbow 60° cone

(DKR-OR 90°)

Product number	hose I.D.		Dimension				
	in	mm	dash size	T	E	H	C
0148-04-04	1/4	6.4	04	1/4-19	19	22	27
0148-04-06	1/4	6.4	04	3/8-19	22	23	27
0148-06-06	3/8	9.5	06	3/8-19	22	23	27
0148-06-08	3/8	9.5	06	1/2-14	27	30	33
0148-08-08	1/2	12.7	08	1/2-14	27	35	42
0141-10-10	5/8	15.9	10	5/8-14	30	54	37
0141-12-12	3/4	19	12	3/4-14	32	58	56
0141-16-16	1	25.4	16	1-11	38	67	70

0241

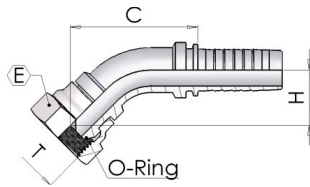

0248

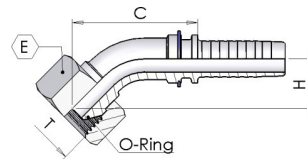

BSP O'Ring 45° Swept Elbow 60° Cone

(DKR-OR 45°)

Product number	hose I.D.		Dimension				
	in	mm	dash size	T	E	H	C
0248-04-04	1/4	6.4	04	1/4-19	19	15	41
0248-06-06	3/8	9.5	06	3/8-19	22	15	47
0248-08-08	1/2	12.7	08	1/2-14	27	19	61
0241-12-12	3/4	19	12	3/4-14	32	28	88
0241-16-16	1	25.4	16	1-11	38	32	114

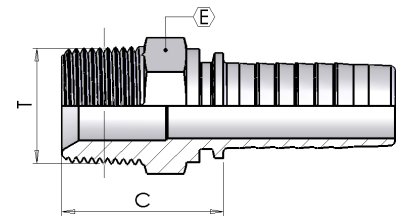
0360**BSP Taper Male 60° cone****(AGR-K)**

Product number	hose I.D.		I.D.	Dimension		
	in	mm		dash size	T	E
0360-03-02	3/16	4.8	03	1/8-28	12	21
0360-03-04	3/16	4.8	03	1/4-19	15	27
0360-04-02	1/4	6.4	04	1/8-28	12	22
0360-04-04	1/4	6.4	04	1/4-19	15	28
0360-04-06	1/4	6.4	04	3/8-19	19	28
0360-05-04	5/16	7.9	05	1/4-19	15	28
0360-05-06	5/16	7.9	05	3/8-19	19	28
0360-06-04	3/8	9.5	06	1/4-19	17	28
0360-06-06	3/8	9.5	06	3/8-19	19	28
0360-06-08	3/8	9.5	06	1/2-14	22	33
0360-08-06	1/2	12.7	08	3/8-19	19	29
0360-08-08	1/2	12.7	08	1/2-14	22	34
0360-08-12	1/2	12.7	08	3/4-14	27	36
0360-12-12	3/4	19	12	3/4-14	27	37
0360-12-16	3/4	19	12	1-11	36	43
0360-16-16	1	25.4	16	1-11	36	44
0360-20-20	1.1/4	31.8	20	1.1/4-11	46	47
0360-24-24	1.1/2	38.1	24	1.1/2-11	50	49
0360-32-32	2	50.8	32	2-11	65	55

0370

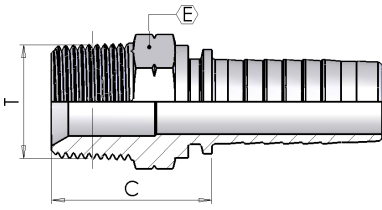

NPTF Male 60° cone

(AGN)

Product number	hose I.D.		Dimension			
	in	mm	dash size	Cut-off C	T	E
0370-03-02	3/16	4.8	03	22	1/8-27	12
0370-03-04	3/16	4.8	03	27	1/4-18	15
0370-04-02	1/4	6.4	04	22	1/8-27	12
0370-04-04	1/4	6.4	04	28	1/4-18	15
0370-04-06	1/4	6.4	04	28	3/8-18	19
0370-05-04	5/16	7.9	05	28	1/4-18	15
0370-05-06	5/16	7.9	05	28	3/8-18	19
0370-06-04	3/8	9.5	06	28	1/4-18	17
0370-06-06	3/8	9.5	06	28	3/8-18	19
0370-06-08	3/8	9.5	06	34	1/2-14	22
0370-08-06	1/2	12.7	08	29	3/8-18	19
0370-08-08	1/2	12.7	08	35	1/2-14	22
0370-08-12	1/2	12.7	08	36	3/4-14	27
0370-10-08	5/8	15.9	10	35	1/2-14	24
0370-10-12	5/8	15.9	10	36	3/4-14	27
0370-12-08	3/4	19	12	36	1/2-14	24
0370-12-12	3/4	19	12	37	3/4-14	27
0370-12-16	3/4	19	12	43	1-11.1/2	36
0370-16-16	1	25.4	16	44	1-11.1/2	36
0370-20-20	1.1/4	31.8	20	47	1.1/4-11.1/2	46
0370-24-24	1.1/2	38.1	24	49	1.1/2-11.1/2	50
0370-32-32	2	50.8	32	55	2-11.1/2	65
0370-40-40	2.1/2	63.5	40	55	2.1/2-8	80
0370-48-48	3	76.2	48	58	3-8	90

037G

NPTF Male Parallel 60° Cone - Rotating (AGN-RO)

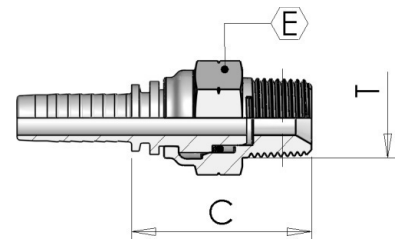

Product number	hose I.D.		I.D.	Dimension		
	in	mm		dash size	T	E
037G-04-04	1/4	6.4	04	1/4-18	19	39
037G-06-06	3/8	9.5	06	3/8-18	22	43
037G-08-08	1/2	12.7	08	1/2-14	27	49
037G-12-12	3/4	19	12	3/4-14	32	52

N051

NPSM Female 60° Cone Rolled Nut (DKN)

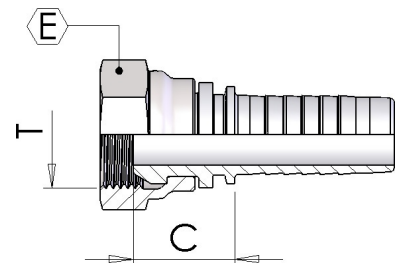

Product number	hose I.D.		I.D.	Dimension		
	in	mm		dash size	T	E
N051-03-04	3/16	4.8	03	1/4-18	19	17
N051-04-04	1/4	6.4	04	1/4-18	19	17
N051-06-06	3/8	9.5	06	3/8-18	22	19
N051-08-08	1/2	12.7	08	1/2-14	27	23
N051-12-12	3/4	19.1	12	3/4-14	32	25
N051-16-16	1	25.4	16	1-11	38	27

0850

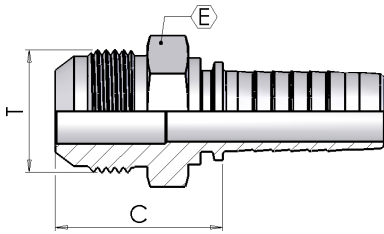

JIC Male 74° cone

(AGJ)

Product number	hose I.D.		I.D.	Dimension		
	in	mm		dash size	T	E
0850-03-04	3/16	4.8	03	7/16-20	12	26
0850-04-04	1/4	6.4	04	7/16-20	12	27
0850-04-05	1/4	6.4	04	1/2-20	14	27
0850-04-06	1/4	6.4	04	9/16-18	15	27
0850-05-05	5/16	7.9	05	1/2-20	14	27
0850-05-06	5/16	7.9	05	9/16-18	15	27
0850-05-08	5/16	7.9	05	3/4-16	19	30
0850-06-06	3/8	9.5	06	9/16-18	15	27
0850-06-07	3/8	9.5	06	5/8-18	17	30
0850-06-08	3/8	9.5	06	3/4-16	19	30
0850-06-10	3/8	9.5	06	7/8-14	24	34
0850-08-08	1/2	12.7	08	3/4-16	19	31
0850-08-10	1/2	12.7	08	7/8-14	24	35
0850-08-12	1/2	12.7	08	1.1/16-12	27	37
0850-10-10	5/8	15.9	10	7/8-14	24	35
0850-10-12	5/8	15.9	10	1.1/16-12	27	37
0850-12-10	3/4	19	12	7/8-14	24	36
0850-12-12	3/4	19	12	1.1/16-12	27	38
0850-12-14	3/4	19	12	1.3/16-12	32	41
0850-12-16	3/4	19	12	1.5/16-12	34	42
0850-16-12	1	25.4	16	1.1/16-12	27	39
0850-16-16	1	25.4	16	1.5/16-12	34	43
0850-16-20	1	25.4	16	1.5/8-12	42	46
0850-20-20	1.1/4	31.8	20	1.5/8-12	42	47
0850-20-24	1.1/4	31.8	20	1.7/8-12	50	52
0850-24-24	1.1/2	38.1	24	1.7/8-12	50	52
0850-32-32	2	50.8	32	2.1/2-12	65	62

0900

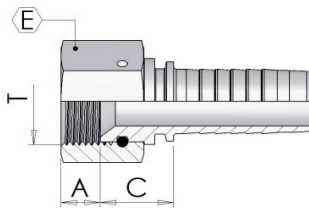

0901

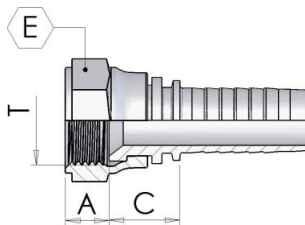

0902

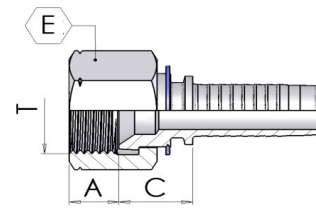

JIC Female 74°

(DKJ)

Product number	hose I.D.		Dimension				
	in	mm	dash size	T	E	Cut-off C	A
0901-03-04	3/16	4.8	03	7/16-20	15	14	8.5
0901-03-05	3/16	4.8	03	1/2-20	17	14	9.5
0901-04-04	1/4	6.4	04	7/16-20	15	14	8.5
0902-04-05	1/4	6.4	04	1/2-20	17	17	9.5
0902-04-06	1/4	6.4	04	9/16-18	19	17	9
0901-04-07	1/4	6.4	04	5/8-18	22	17	11
0901-05-05	5/16	7.9	05	1/2-20	17	17	9.5
0901-05-07	5/16	7.9	05	5/8-18	22	17	11
0901-06-04	3/8	9.5	06	7/16-20	15	15	9
0901-06-05	3/8	9.5	06	1/2-20	17	15	9.5
0901-06-06	3/8	9.5	06	9/16-18	19	16	9
0901-06-07	3/8	9.5	06	5/8-18	22	16	11
0902-06-08	3/8	9.5	06	3/4-16	22	18	10.5
0901-08-08	1/2	12.7	08	3/4-16	24	18	10.5
0902-08-10	1/2	12.7	08	7/8-14	27	20	13
0901-10-10	5/8	15.9	10	7/8-14	27	20	13
0902-10-12	5/8	15.9	10	1.1/16-12	32	20	13.5
0901-12-10	3/4	19	12	7/8-14	27	20	13
0902-12-12	3/4	19	12	1.1/16-12	32	22	13.5
0901-12-14	3/4	19	12	1.3/16-12	36	23	14
0901-12-16	3/4	19	12	1.5/16-12	38	23	15.5
0901-16-12	1	25.4	12	1.1/16-12	32	23	13.5
0901-16-16	1	25.4	16	1.5/16-12	38	24	15.5
0900-16-20	1	25.4	16	1.5/8-12	50	27	16.5
0900-20-20	1.1/4	31.8	20	1.5/8-12	50	28	16.5
0900-20-24	1.1/4	31.8	20	1.7/8-12	55	31	19
0900-24-24	1.1/2	38.1	24	1.7/8-12	55	31	19
0900-32-32	2	50.8	32	2.1/2-12	70	31	20

0901D

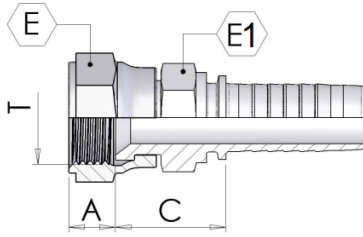

JIC Female 74° Cone- Double Hexagon

(DKJ)

Product number	hose I.D.		Dimension					
	in	mm	dash size	T	E	E1	C	A
0901D04-04	1/4	6.4	04	7/16-20	15	12	20	8.5
0901D04-05	1/4	6.4	04	1/2-20	17	14	20	9.5
0901D04-06	1/4	6.4	04	9/16-18	19	14	22	9
0901D06-06	3/8	9.5	06	9/16-18	19	17	24	9
0901D06-08	3/8	9.5	06	3/4-16	24	19	26	10.5
0901D08-08	1/2	12.7	08	3/4-16	24	22	26	10.5
0901D08-10	1/2	12.7	08	7/8-14	27	22	27	13
0901D10-10	5/8	15.9	10	7/8-14	27	22	26	13
0901D10-12	5/8	15.9	10	1.1/16-12	32	27	27	13.5
0901D12-12	3/4	19	12	1.1/16-12	32	27	32	13.5
0901D16-16	1	25.4	16	1.5/16-12	38	36	33	15.5

0950

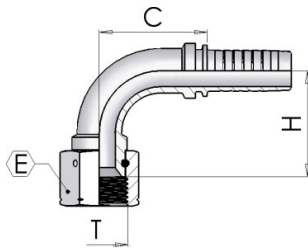

0951

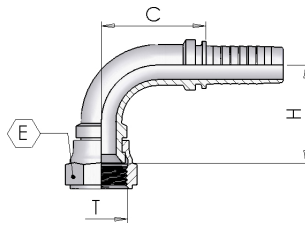

0952

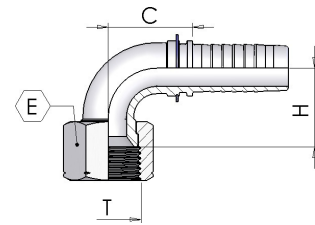

JIC 90° Swept Elbow 74° cone

Product number	hose I.D.		Dimension				
	in	mm	dash size	T	E	H	C
0951-03-04	3/16	4.8	03	7/16-20	15	22	22
0951-03-05	3/16	4.8	03	1/2-20	17	22	22
0951-04-04	1/4	6.4	04	7/16-20	15	22	22
0952-04-05	1/4	6.4	04	1/2-20	17	21	27
0952-04-06	1/4	6.4	04	9/16-18	19	21	26
0951-05-05	5/16	7.9	05	1/2-20	17	30	29
0951-05-06	5/16	7.9	05	9/16-18	19	31	29
0951-06-05	3/8	9.5	06	1/2-20	17	33	30
0951-06-06	3/8	9.5	06	9/16-18	19	32	31
0951-06-07	3/8	9.5	06	5/8-18	22	32	33
0952-06-08	3/8	9.5	06	3/4-16	22	34	41
0951-06-10	3/8	9.5	06	7/8-14	27	36	33
0951-08-08	1/2	12.7	08	3/4-16	24	41	41
0952-08-10	1/2	12.7	08	7/8-14	27	34	41
0951-08-12	1/2	12.7	08	1.1/16-12	32	43	42
0951-10-10	5/8	15.9	10	7/8-14	27	44	43
0951-12-10	3/4	19	12	7/8-14	27	53	56
0952-10-12	5/8	15.9	10	1.1/16-12	32	37	47
0952-12-12	3/4	19	12	1.1/16-12	32	45	58
0951-12-14	3/4	19	12	1.3/16-12	36	53	56
0951-12-16	3/4	19	12	1.5/16-12	38	55	60
0951-16-12	1	25.4	16	1.1/16-12	38	55	60
0951-16-16	1	25.4	16	1.5/16-12	32	63	70
0950-20-20	1.1/4	31.8	20	1.5/8-12	50	85	82
0950-24-24	1.1/2	38.1	24	1.7/8-12	55	97	104
0950-32-32	2	50.8	32	2.1/2-12	70	134	124

1000

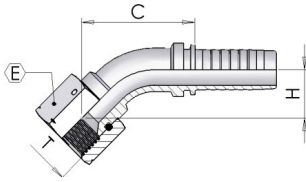

1001

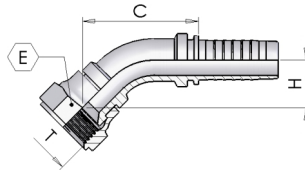

1002

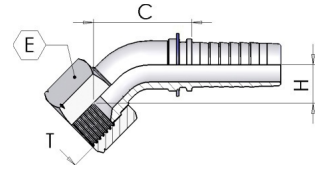

JIC 45° Swept Elbow 74°

(DKJ-45°)

Product number	hose I.D.		Dimension				
	in	mm	dash size	T	E	H	C
1001-03-04	3/16	4.8	03	7/16-20	15	15	33
1001-04-04	1/4	6.4	04	7/16-20	15	13	38
1002-04-05	1/4	6.4	04	1/2-20	17	11	38
1002-04-06	1/4	6.4	04	9/16-18	19	11	38
1001-05-05	5/16	7.9	05	1/2-20	17	17	46
1001-05-06	5/16	7.9	05	9/16-18	19	18	47
1001-06-05	3/8	9.5	06	1/2-20	17	18	49
1001-06-06	3/8	9.5	06	9/16-18	19	17	51
1002-06-08	3/8	9.5	06	3/4-16	22	13	48
1001-06-10	3/8	9.5	06	7/8-14	27	21	54
1001-08-08	1/2	12.7	08	3/4-16	24	22	62
1002-08-10	1/2	12.7	08	7/8-14	27	16	58
1001-08-12	1/2	12.7	08	1.1/16-12	32	25	68
1001-10-10	5/8	15.9	10	7/8-14	27	24	68
1002-10-12	5/8	15.9	10	1.1/16-12	32	18	66
1002-12-12	3/4	19	12	1.1/16-12	32	21	81
1001-12-14	3/4	19	12	1.3/16-12	36	29	84
1001-12-16	3/4	19	12	1.5/16-12	38	28	88
1001-16-16	1	25.4	16	1.5/16-12	38	29	83
1000-20-20	1.1/4	31.8	20	1.5/8-12	50	42	108
1000-24-24	1.1/2	38.1	24	1.7/8-12	55	49	156
1000-32-32	2	50.8	32	2.1/2-12	70	65	142

095S

JIC 90° Swept Elbow 74° cone - ISO SHORT

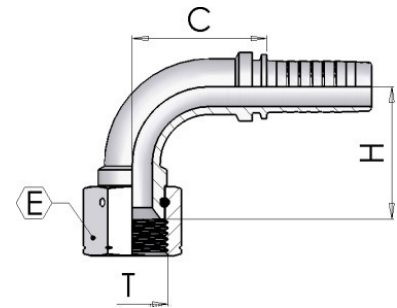

Product number	hose I.D.		Dimension				
	in	mm	dash size	T	E	H	C
095S-04-04	1/4	6.4	04	7/16-20	15	22	25
095S-06-06	3/8	9.5	06	9/16-18	19	23	31
095S-08-08	1/2	12.7	08	3/4-16	24	29	41
095S-10-10	5/8	15.9	10	7/8-14	27	32	43
095S-12-12	3/4	19	12	1.1/16-12	32	48	56
095S-16-16	1	25.4	16	1.5/16-12	41	57	70

2971

JIC 90° Compact Elbow 74° cone - Crimped Nut (DKJ-90°K)

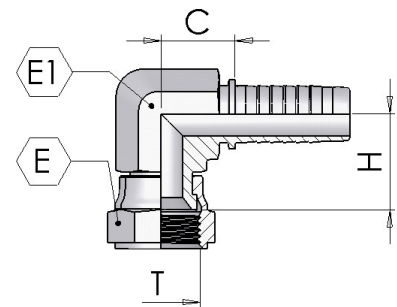

Product number	hose I.D.		Dimension					
	in	mm	dash size	T	E	E1	H	C
2971-04-04	1/4	6.4	04	7/16-20	15	15	17	19
2971-04-05	1/4	6.4	04	1/2-20	17	15	18	19
2971-04-06	1/4	6.4	04	9/16-18	19	15	21	19
2971-05-06	5/16	7.9	05	9/16-18	19	17	21	23
2971-06-06	3/8	9.5	06	9/16-18	19	17	20	24
2971-06-08	3/8	9.5	06	3/4-16	24	19	22	25
2971-08-08	1/2	12.7	08	3/4-16	24	22	22.5	26.5
2971-08-10	1/2	12.7	08	7/8-14	27	22	23.5	26.5
2971-12-12	3/4	19.1	12	1.1/16-12	32	27	28.5	31.5
2971-16-16	1	25.4	16	1.5/16-12	38	32	33.5	37.5

0385

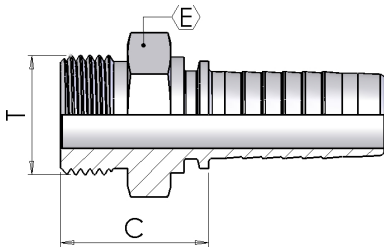

SAE Male O'R Flat Seat

(SAE-OR)

Product number	hose I.D.	I.D.	Dimension			
	in	mm	dash size	T	E	Cut-off C
0385-04-04	1/4	6.4	04	7/16-20	14	24
0385-04-06	1/4	6.4	04	9/16-18	17	24
0385-05-06	5/16	7.9	05	9/16-18	17	24
0385-06-06	3/8	9.5	06	9/16-18	17	25
0385-06-08	3/8	9.5	06	3/4-16	22	28
0385-08-08	1/2	12.7	08	3/4-16	22	28
0385-08-10	1/2	12.7	08	7/8-14	27	30
0385-08-12	1/2	12.7	08	1.1/16-12	32	32
0385-10-10	5/8	15.9	10	7/8-14	27	30
0385-10-12	5/8	15.9	10	1.1/16-12	32	32
0385-12-12	3/4	19	12	1.1/16-12	32	33

Metric Male 24° Seat Light

(CEL)

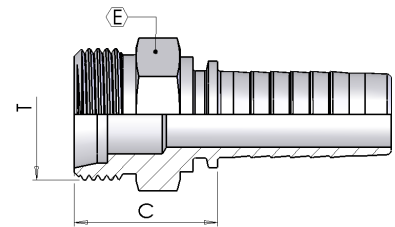

Product number	hose I.D.		Dimension				I.D. Cut-off C
	in	dash size	mm	T	erm.	E	
0500-03-12	3/16	03	4.8	M12-1.5	6	14	22
0500-03-14	3/16	03	4.8	M14-1.5	8	14	22
0500-04-12	1/4	04	6.4	M12-1.5	6	14	23
0500-04-14	1/4	04	6.4	M14-1.5	8	14	22
0500-04-16	1/4	04	6.4	M16-1.5	10	17	23
0500-04-18	1/4	04	6.4	M18-1.5	12	19	24
0500-05-14	5/16	05	7.9	M14-1.5	8	14	22
0500-05-16	5/16	05	7.9	M16-1.5	10	17	23
0500-05-18	5/16	05	7.9	M18-1.5	12	19	24
0500-05-22	5/16	05	7.9	M22-1.5	15	22	25
0500-06-16	3/8	06	9.5	M16-1.5	10	17	23
0500-06-18	3/8	06	9.5	M18-1.5	12	19	24
0500-06-22	3/8	06	9.5	M22-1.5	15	22	25
0500-08-18	1/2	08	12.7	M18-1.5	12	19	25
0500-08-22	1/2	08	12.7	M22-1.5	15	22	26
0500-08-26	1/2	08	12.7	M26-1.5	18	27	27
0500-10-22	5/8	10	15.9	M22-1.5	15	22	26
0500-10-26	5/8	10	15.9	M26-1.5	18	27	27
0500-10-30	5/8	10	15.9	M30-2	22	30	32
0500-12-26	3/4	12	19	M26-1.5	18	27	28
0500-12-30	3/4	12	19	M30-2	22	30	33
0500-16-36	1	16	25.4	M36-2	28	36	32
0500-20-45	1.1/4	20	31.8	M45-2	35	46	36
0500-24-52	1.1/2	24	38.1	M52-2	42	55	38

0085

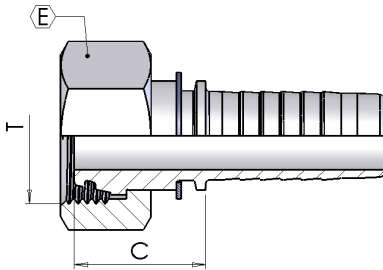

Metric Female 24° Seat Light

(DKOL)

Product number	hose I.D.		Dimension				I.D.
	in	dash size	mm	T	erm.	€	Cut-off C
0085-03-12	3/16	03	4.8	M12-1.5	6	14	23
0085-03-14	3/16	03	4.8	M14-1.5	8	17	24
0085-04-12*	1/4	04	6.4	M12-1.5	6	14	25
0085-04-14	1/4	04	6.4	M14-1.5	8	17	24
0085-04-16	1/4	04	6.4	M16-1.5	10	19	24
0085-04-18	1/4	04	6.4	M18-1.5	12	22	25
0085-05-14*	5/16	05	7.9	M14-1.5	8	17	26
0085-05-16	5/16	05	7.9	M16-1.5	10	19	24
0085-05-18	5/16	05	7.9	M18-1.5	12	22	25
0085-06-16*	3/8	06	9.5	M16-1.5	10	19	25
0085-06-18	3/8	06	9.5	M18-1.5	12	22	25
0085-06-22	3/8	06	9.5	M22-1.5	15	27	29
0085-08-18*	1/2	08	12.7	M18-1.5	12	22	28
0085-08-22	1/2	08	12.7	M22-1.5	15	27	29
0085-08-26	1/2	08	12.7	M26-1.5	18	32	29
0085-10-22*	5/8	10	15.9	M22-1.5	15	27	31
0085-10-26	5/8	10	15.9	M26-1.5	18	32	29
0085-10-30	5/8	10	15.9	M30-2	22	36	29
0085-12-26*	3/4	12	19	M26-1.5	18	32	35
0085-12-30	3/4	12	19	M30-2	22	36	29
0085-12-36	3/4	12	19	M36-2	28	41	28
0085-16-36	1	16	25.4	M36-2	28	41	30
0085-20-45	1.1/4	20	31.8	M45-2	35	50	40
0085-20-52	1.1/4	20	31.8	M52-2	42	60	43
0085-24-52	1.1/2	24	38.1	M52-2	42	60	41

*Rolled Nut

0185

90° Metric Swept Elbow 24° Seat Light

(DKOL-90°)

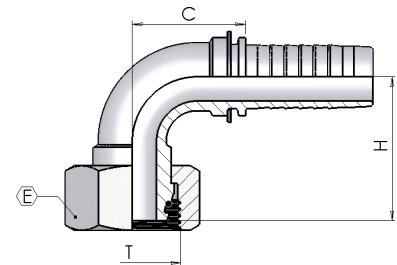

Product number	hose I.D.		Dimension					
	in	mm	dash size	T	erm.	E	H	Cut-off C
0185-03-12	3/16	4.8	03	M12-1.5	6	14	23	22
0185-03-14	3/16	4.8	03	M14-1.5	8	17	24	23
0185-04-12*	1/4	6.4	04	M12-1.5	6	14	34	26
0185-04-14	1/4	6.4	04	M14-1.5	8	17	26	26
0185-04-16	1/4	6.4	04	M16-1.5	10	19	27	25
0185-04-18	1/4	6.4	04	M18-1.5	12	22	30	27
0185-05-14*	5/16	7.9	05	M14-1.5	8	19	38	30
0185-05-16	5/16	7.9	05	M16-1.5	10	19	31	31
0185-05-18	5/16	7.9	05	M18-1.5	12	22	32	31
0185-06-16*	3/8	9.5	06	M16-1.5	10	19	39	32
0185-06-18	3/8	9.5	06	M18-1.5	12	22	35	32
0185-06-22	3/8	9.5	06	M22-1.5	15	27	35	32
0185-08-18*	1/2	12.7	08	M18-1.5	12	24	48	40
0185-08-22	1/2	12.7	08	M22-1.5	15	27	38	41
0185-08-26	1/2	12.7	08	M26-1.5	18	32	39	41
0185-10-22*	5/8	15.9	10	M22-1.5	15	27	55	42
0185-10-26	5/8	15.9	10	M26-1.5	18	32	44	44
0185-12-30	3/4	19	12	M30-2	22	36	52	58
0185-16-36	1	25.4	16	M36-2	28	41	62	72
0185-20-45	1.1/4	31.8	20	M45-2	35	50	81	84
0185-24-52	1.1/2	38.1	24	M52-2	42	60	93	102

*Rolled Nut

0285

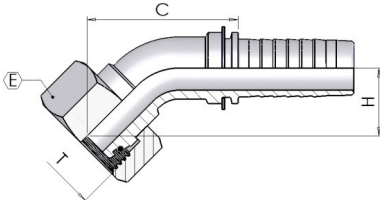

45° Metric Swept Elbow 24° Seat Light

(DKOL-45°)

Product number	hose I.D.		I.D.	Dimension				
	in	mm		dash size	T	erm.	E	H
0285-03-12	3/16	4.8	03	M12-1.5	6	14	14	36
0285-04-12*	1/4	6.4	04	M12-1.5	6	14	21	46
0285-04-14	1/4	6.4	04	M14-1.5	8	17	14	42
0285-04-16	1/4	6.4	04	M16-1.5	10	19	15	42
0285-04-18	1/4	6.4	04	M18-1.5	12	22	16	43
0285-05-16	5/16	7.9	05	M16-1.5	10	19	17	48
0285-05-18	5/16	7.9	05	M18-1.5	12	22	18	48
0285-06-16*	3/8	9.5	06	M16-1.5	10	19	22	55
0285-06-18	3/8	9.5	06	M18-1.5	12	22	19	52
0285-06-22	3/8	9.5	06	M22-1.5	15	27	19	51
0285-08-22	1/2	12.7	08	M22-1.5	15	27	21	63
0285-08-26	1/2	12.7	08	M26-1.5	18	32	22	63
0285-10-22*	5/8	15.9	10	M22-1.5	15	27	32	75
0285-10-26	5/8	15.9	10	M26-1.5	18	32	23	68
0285-12-30	3/4	19	12	M30-2	22	36	25	86
0285-16-36	1	25.4	16	M36-2	28	41	29	81
0285-20-45	1.1/4	31.8	20	M45-2	35	50	32	106
0285-24-52	1.1/2	38.1	24	M52-2	42	60	43	119

*Rolled Nut

Metric Male 24° Seat Heavy

(CES)

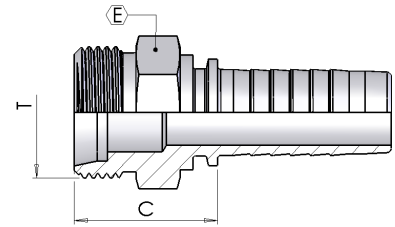

Product number	hose I.D.		Dimension				
	in	mm	dash size	T	erm.	E	Cut-off C
0450-03-16	3/16	4.8	03	M16-1.5	8	17	26
0450-04-14	1/4	6.4	04	M14-1.5	6	14	25
0450-04-16	1/4	6.4	04	M16-1.5	8	17	27
0450-04-18	1/4	6.4	04	M18-1.5	10	19	27
0450-04-20	1/4	6.4	04	M20-1.5	12	22	27
0450-05-18	5/16	7.9	05	M18-1.5	10	19	27
0450-05-20	5/16	7.9	05	M20-1.5	12	22	29
0450-06-18	3/8	9.5	06	M18-1.5	10	19	27
0450-06-20	3/8	9.5	06	M20-1.5	12	22	29
0450-06-22	3/8	9.5	06	M22-1.5	14	22	31
0450-06-24	3/8	9.5	06	M24-1.5	16	24	31
0450-08-20	1/2	12.7	08	M20-1.5	12	22	29
0450-08-22	1/2	12.7	08	M22-1.5	14	22	31
0450-08-24	1/2	12.7	08	M24-1.5	16	24	32
0450-08-30	1/2	12.7	08	M30-2	20	30	33
0450-10-30	5/8	15.9	10	M30-2	20	30	34
0450-12-30	3/4	19	12	M30-2	20	30	35
0450-12-36	3/4	19	12	M36-2	25	36	38
0450-16-36	1	25.4	16	M36-2	25	36	39
0450-16-42	1	25.4	16	M42-2	30	46	42
0450-20-42	1.1/4	31.8	20	M42-2	30	46	43
0450-20-52	1.1/4	31.8	20	M52-2	38	55	45
0450-24-52	1.1/2	38.1	24	M52-2	38	55	45

0084

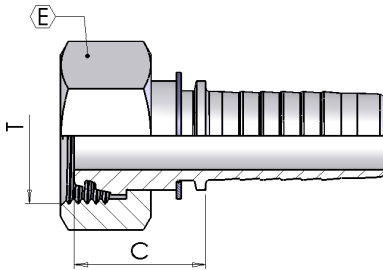

Metric Female 24° Seat Heavy

(DKOS)

Product number	hose I.D.		dash size	Dimension			
	in	mm		T	erm.	E	Cut-off C
0084-03-14	3/16	4.8	03	M14-1.5	6	17	22
0084-03-16	3/16	4.8	03	M16-1.5	8	19	25
0084-04-14	1/4	6.4	04	M14-1.5	6	17	23
0084-04-16	1/4	6.4	04	M16-1.5	8	19	25
0084-04-18	1/4	6.4	04	M18-1.5	10	22	24
0084-04-20	1/4	6.4	04	M20-1.5	12	24	22
0084-05-16	5/16	7.9	05	M16-1.5	8	19	26
0084-05-18	5/16	7.9	05	M18-1.5	10	22	25
0084-05-20	5/16	7.9	05	M20-1.5	12	24	25
0084-06-18	3/8	9.5	06	M18-1.5	10	22	25
0084-06-20	3/8	9.5	06	M20-1.5	12	24	25
0084-06-22	3/8	9.5	06	M22-1.5	14	27	29
0084-06-24	3/8	9.5	06	M24-1.5	16	30	29
0084-08-20*	1/2	12.7	08	M20-1.5	12	27	28
0084-08-22	1/2	12.7	08	M22-1.5	14	27	17
0084-08-24	1/2	12.7	08	M24-1.5	16	30	30
0084-08-30	1/2	12.7	08	M30-2	20	36	33
0084-10-24*	5/8	15.9	10	M24-1.5	16	30	31
0084-10-30	5/8	15.9	10	M30-2	20	36	33
0084-12-30	3/4	19	12	M30-2	20	36	34
0084-12-36	3/4	19	12	M36-2	25	46	40
0084-16-36	1	25.4	16	M36-2	25	46	41
0084-16-42	1	25.4	16	M42-2	30	50	43
0084-20-52	1.1/4	31.8	20	M52-2	38	60	44
0084-24-52	1.1/2	38.1	24	M52-2	38	60	44

*Rolled Nut

0184

90° Metric Swept Elbow 24° Seat Heavy

(DKOS-90°)

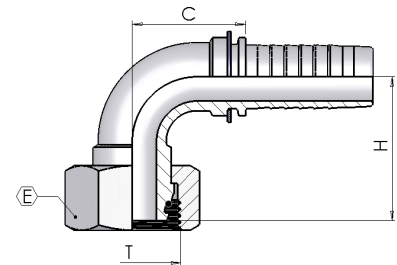

Product number	hose I.D. / I.D.		Dimension					
	in	mm	dash size	T	erm.	E	H	Cut-off C
0184-03-16	3/16	4.8	03	M16-1.5	8	19	25	22
0184-04-14	1/4	6.4	04	M14-1.5	6	17	26	27
0184-04-16	1/4	6.4	04	M16-1.5	8	19	26	26
0184-04-18	1/4	6.4	04	M18-1.5	10	22	31	27
0184-04-20	1/4	6.4	04	M20-1.5	12	24	30	27
0184-05-18	5/16	7.9	05	M18-1.5	10	22	33	33
0184-05-20	5/16	7.9	05	M20-1.5	12	24	34	30
0184-06-18	3/8	9.5	06	M18-1.5	10	22	35	34
0184-06-20	3/8	9.5	06	M20-1.5	12	24	34	34
0184-06-22	3/8	9.5	06	M22-1.5	14	27	33	33
0184-06-24	3/8	9.5	06	M24-1.5	16	30	35	33
0184-08-20*	1/2	12.7	08	M20-1.5	12	27	48	40
0184-08-22	1/2	12.7	08	M22-1.5	14	27	41	40
0184-08-24	1/2	12.7	08	M24-1.5	16	30	41	40
0184-10-24*	5/8	15.9	10	M24-1.5	16	30	60	42
0184-10-30	5/8	15.9	10	M30-2	20	36	50	46
0184-12-30	3/4	19	12	M30-2	20	36	56	58
0184-12-36	3/4	19	12	M36-2	25	46	57	59
0184-16-36	1	25.4	16	M36-2	25	46	67	77
0184-16-42	1	25.4	16	M42-2	30	50	67	72
0184-20-52	1.1/4	31.8	20	M52-2	38	60	82	84
0184-24-52	1.1/2	38.1	24	M52-2	38	60	105	105

*Rolled Nut

0284

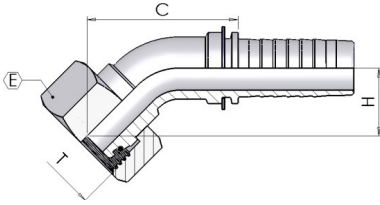

45° Metric Swept Elbow 24° Seat Heavy

(DKOS-45°)

Product number	hose I.D.		I.D.	Dimension				
	in	mm		dash size	T	erm.	E	H
0284-03-16	3/16	4.8	03	M16-1.5	8	19	16	36
0284-04-14	1/4	6.4	04	M14-1.5	6	17	15	37
0284-04-16	1/4	6.4	04	M16-1.5	8	19	15	42
0284-04-18	1/4	6.4	04	M18-1.5	10	22	18	45
0284-05-20	5/16	7.9	05	M20-1.5	12	24	19	49
0284-06-18	3/8	9.5	06	M18-1.5	10	22	19	51
0284-06-20	3/8	9.5	06	M20-1.5	12	24	18	53
0284-06-22	3/8	9.5	06	M22-1.5	14	27	20	54
0284-08-24	1/2	12.7	08	M24-1.5	16	30	21	63
0284-10-30	5/8	15.9	10	M30-2	20	36	29	74
0284-12-30	3/4	19	12	M30-2	20	36	30	87
0284-12-36	3/4	19	12	M36-2	25	46	29	56
0284-16-36	1	25.4	16	M36-2	25	46	30	85
0284-16-42	1	25.4	16	M42-2	30	50	30	85
0284-20-52	1.1/4	31.8	20	M52-2	38	60	39	105
0284-24-52	1.1/2	38.1	24	M52-2	38	60	53	129

Metric Standpipe

(BEL-BES)

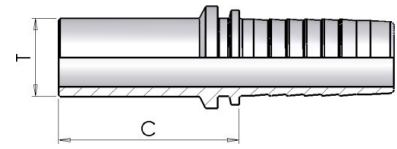

Product number	hose I.D.		Dimension			
	in	mm	dash size	Pipe T	Type	Cut-off C
0550-03-06	3/16	4.8	03	6	L/S	30
0550-03-08	3/16	4.8	03	8	L/S	29
0550-04-06	1/4	6.4	04	6	L/S	32
0550-04-08	1/4	6.4	04	8	L/S	30
0550-04-10	1/4	6.4	04	10	L/S	33
0550-04-12	1/4	6.4	04	12	L/S	30
0550-05-08	5/16	7.9	05	08	L/S	31
0550-05-10	5/16	7.9	05	10	L/S	31
0550-05-12	5/16	7.9	05	12	L/S	33
0550-06-08	3/8	9.5	06	08	L/S	33
0550-06-10	3/8	9.5	06	10	L/S	33
0550-06-12	3/8	9.5	06	12	L/S	32
0550-06-14	3/8	9.5	06	14	S	37
0550-06-15	3/8	9.5	06	15	L	32
0550-08-12	1/2	12.7	08	12	L/S	36
0550-08-14	1/2	12.7	08	14	S	39
0550-08-15	1/2	12.7	08	15	L	34
0550-08-16	1/2	12.7	08	16	S	39
0550-08-18	1/2	12.7	08	18	L	35
0550-08-20	1/2	12.7	08	20	S	45
0550-10-18	5/8	15.9	10	18	L	35
0550-10-20	5/8	15.9	10	20	S	45
0550-10-22	5/8	15.9	10	22	L	33
0550-12-18	3/4	19	12	18	L	37
0550-12-20	3/4	19	12	20	S	46
0550-12-22	3/4	19	12	22	L	38
0550-12-25	3/4	19	12	25	S	49
0550-12-28	3/4	19	12	28	L	40
0550-16-25	1	25.4	16	25	S	51
0550-16-28	1	25.4	16	28	L	41
0550-16-30	1	25.4	16	30	S	54
0550-16-38	1	25.4	16	38	S	60
0550-20-30	1.1/4	31.8	20	30	S	58
0550-20-35	1.1/4	31.8	20	35	L	48
0550-20-38	1.1/4	31.8	20	38	S	62
0550-24-38	1.1/2	38.1	24	38	S	63
0550-24-42	1.1/2	38.1	24	42	L	50

0650

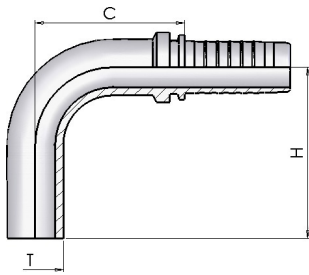

0650S

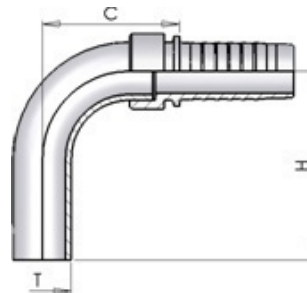

90° Metric Standpipe

(BEL-BES 90°)

Product number	hose I.D.		Dimension				
	in	mm	dash size	Pipe T	Type	H	Cut-off C
0650-03-06	3/16	4.8	03	6	L/S	32	20
0650S03-08	3/16	4.8	03	8	L/S	41	25
0650-04-06	1/4	6.4	04	6	L/S	32	23
0650-04-08	1/4	6.4	04	8	L/S	34	25
0650-04-10	1/4	6.4	04	10	L/S	43	25
0650S04-12	1/4	6.4	04	12	L/S	44	35
0650-05-10	5/16	7.9	05	10	L/S	40	29
0650-05-12	5/16	7.9	05	12	L/S	45	29
0650-06-10	3/8	9.5	06	10	L/S	40	27
0650-06-12	3/8	9.5	06	12	L/S	44	30
0650S06-15	3/8	9.5	06	15	L	52	39
0650S08-12	1/2	12.7	08	12	L/S	44	33
0650S08-15	1/2	12.7	08	15	L	52	39
0650S08-18	1/2	12.7	08	18	L	56	42
0650S10-18	5/8	15.9	10	18	L	56	51
0650S12-22	3/4	19	12	22	L	71	51
0650S12-25	3/4	19	12	25	S	75	57
0650S16-25	1	25.4	16	25	S	75	57
0650S16-28	1	25.4	16	28	L	89	60
0650S24-42	1.1/2	38.1	24	42	L	125	106

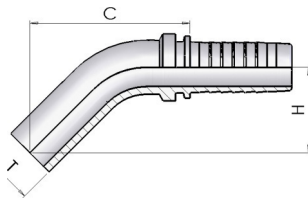
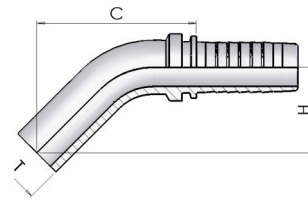
0750**0750S****45° Metric Standpipe****(BEL-BES 45°)**

Product number	hose I.D.		Dimension				
	in	mm	dash size	Pipe T	Type	H	Cut-off C
0750-03-06	3/16	4.8	03	6	L/S	25	38
0750-04-06	1/4	6.4	04	6	L/S	24	41
0750-04-08	1/4	6.4	04	8	L/S	25	43
0750-04-10	1/4	6.4	04	10	L/S	30	47
0750-05-10	5/16	7.9	05	10	L/S	30	49
0750-06-10	3/8	9.5	06	10	L/S	33	50
0750-06-12	3/8	9.5	06	12	L/S	33	52
0750S08-12	1/2	12.7	08	12	L	29	51
0750S08-15	1/2	12.7	08	15	L	29	55
0750S08-18	1/2	12.7	08	18	L	29	56
0750S10-18	5/8	15.7	10	18	L	29	56
0750S12-22	3/4	19	12	22	L	35	65

0035

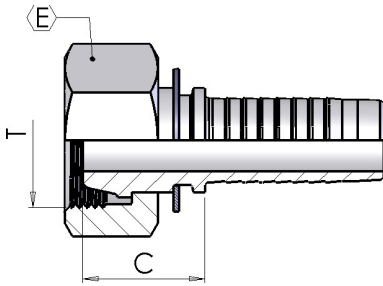

Metric Female 24° Seat Light Multiseal

(DKL)

Product number	hose I.D.		Dimension				I.D.	
	in	dash size	mm	T	erm.	E	Cut-off C	
0035-03-12	3/16	03	4.8	M12-1.5	6	14	19	
0035-03-16	3/16	03	4.8	M16-1.5	10	19	18	
0035-04-14	1/4	04	6.4	M14-1.5	8	17	19	
0035-04-16	1/4	04	6.4	M16-1.5	10	19	19	
0035-05-16	5/16	05	7.9	M16-1.5	10	19	19	
0035-05-18	5/16	05	7.9	M18-1.5	12	22	21	
0035-06-16	3/8	06	9.5	M16-1.5	10	19	23	
0035-06-18	3/8	06	9.5	M18-1.5	12	22	23	
0035-06-22	3/8	06	9.5	M22-1.5	15	27	22	
0035-08-22	1/2	08	12.7	M22-1.5	15	27	22	
0035-08-26	1/2	08	12.7	M26-1.5	18	32	24	
0035-10-26	5/8	10	15.9	M26-1.5	18	32	24	
0035-12-30	3/4	12	19	M30-2	22	36	29	
0035-16-36	1	16	25.4	M36-2	28	41	30	

0135

90° Metric Swept Elbow 24° Seat Light Multiseal

(DKL-90°)

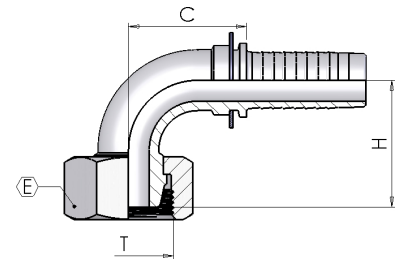

Product number	hose I.D.		Dimension					I.D.
	in	dash size	mm	T	erm.	E	H	Cut-off C
0135-04-14	1/4	04	6.4	M14-1.5	8	17	25	25
0135-04-16	1/4	04	6.4	M16-1.5	10	19	24	26
0135-05-16	5/16	05	7.9	M16-1.5	10	19	29	32
0135-06-18	3/8	06	9.5	M18-1.5	12	22	30	36
0135-08-22	1/2	08	12.7	M22-1.5	15	27	38	41

0400

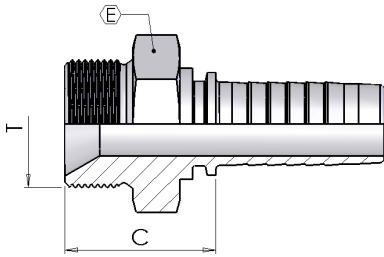

Metric Male 60° cone

(AGM)

Product number	hose I.D.		I.D.	Dimension		
	in	mm		dash size	T	E
0400-03-10	3/16	4.8	03	M10-1	14	19
0400-03-12	3/16	4.8	03	M12-1.5	17	25
0400-04-14	1/4	6.4	04	M14-1.5	19	26
0400-05-16	5/16	7.9	05	M16-1.5	22	26
0400-05-18	5/16	7.9	05	M18-1.5	24	26
0400-06-14	3/8	9.5	06	M14-1.5	19	26
0400-06-16	3/8	9.5	06	M16-1.5	22	26
0400-06-18	3/8	9.5	06	M18-1.5	24	27
0400-08-18	1/2	12.7	08	M18-1.5	24	28
0400-08-22	1/2	12.7	08	M22-1.5	27	30
0400-10-26	5/8	15.9	10	M26-1.5	32	32
0400-12-30	3/4	19	12	M30-1.5	36	36
0400-16-38	1	25.4	16	M38-1.5	46	37
0400-20-45	1.1/4	31.8	20	M45-1.5	55	39

0100

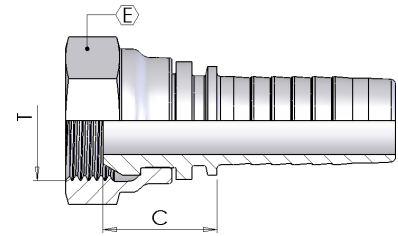
Metric Female 60° cone**(DKM)**

Product number	hose I.D.		I.D.	Dimension		
	in	mm		dash size	T	E
0100-03-10	3/16	4.8	03	M10-1	14	15
0100-04-10	1/4	6.4	04	M10-1	14	15
0100-04-14	1/4	6.4	04	M14-1.5	19	17
0100-05-14	5/16	7.9	05	M14-1.5	19	17
0100-05-16	5/16	7.9	05	M16-1.5	22	19
0100-05-18	5/16	7.9	05	M18-1.5	24	19
0100-06-14	3/8	9.5	06	M14-1.5	19	17
0100-06-16	3/8	9.5	06	M16-1.5	22	19
0100-06-18	1/2	12.7	08	M18-1.5	24	19
0100-08-18	1/2	12.7	08	M18-1.5	24	20
0100-08-20	1/2	12.7	08	M20-1.5	27	22.5
0100-08-22	1/2	12.7	08	M22-1.5	27	22.5
0100-10-26	5/8	15.9	10	M26-1.5	32	25
0100-12-30	3/4	19	12	M30-1.5	36	26
0100-16-38	1	25.4	16	M38-1.5	46	33
0100-20-45	1.1/4	31.8	20	M45-1.5	50	34
0100-24-52	1.1/2	38	24	M52x1.5	60	35
0100-32-65	2	50.8	32	M65-2	75	31

0200

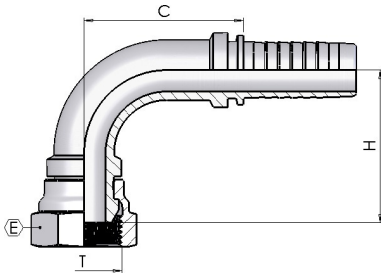

90° Metric Swept Elbow 60° cone

(DKM-90°)

Product number	hose I.D.		Dimension				I.D.
	in	dash size	mm	T	E	H	Cut-off C
0200-03-10	3/16	03	4.8	M10-1	14	23	22
0200-04-10	1/4	04	6.4	M10-1	14	25	24
0200-04-14	1/4	04	6.4	M14-1.5	19	26	24
0200-05-14	5/16	05	7.9	M14-1.5	19	31	29
0200-05-16	5/16	05	7.9	M16-1.5	22	35	29
0200-05-18	5/16	05	7.9	M18-1.5	24	35	29
0200-06-16	3/8	06	9.5	M16-1.5	22	34	33
0200-06-18	3/8	06	9.5	M18-1.5	24	34	33
0200-08-22	1/2	08	12.7	M22-1.5	27	40	41
0200-12-30	3/4	12	19	M30-1.5	36	36	57
0200-16-38	1	16	25.4	M38-1.5	46	71	70

S350

ORFS Male

(ORFS)

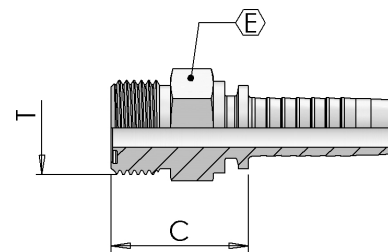

Product number	hose I.D.		Dimension			
	in	mm	dash size	T	E	Cut-off C
S350-04-06-BO	1/4	6.4	04	9/16-18	17	23
S350-04-09-BO	1/4	6.4	04	11/16-16	19	21
S350-05-09-BO	5/16	7.9	05	11/16-16	19	26
S350-06-09-BO	3/8	9.5	06	11/16-16	19	26
S350-06-11-BO	3/8	9.5	6	13/16-16	22	29
S350-08-11-BO	1/2	12.7	08	13/16-16	22	29
S350-08-13-BO	1/2	12.7	08	1-14	27	34
S350-08-14-BO	1/2	12.7	08	1.3/16-12	32	35
S350-10-13-BO	5/8	15.9	10	1-14	27	33
S350-10-14-BO	5/8	15.9	10	1.3/16-12	32	35
S350-12-14-BO	3/4	19	12	1.3/16-12	32	36
S350-12-15-BO	3/4	19	12	1.7/16-12	38	36
S350-16-15-BO	1	25.4	16	1.7/16-12	38	37
S350-16-21-BO	1	25.4	16	1.11/16-12	46	38
S350-20-21-BO	1.1/4	31.8	20	1.11/16-12	46	39

- with plug and O-Ring

S050

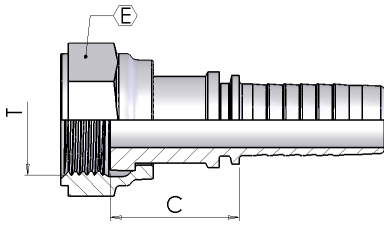

ORFS Female

(ORFS)

Product number	hose I.D.		I.D.	dash size	Dimension		
	in	mm			T	E	Cut-off C
S050-04-06	1/4	6.4	04	9/16-18	19	25	
S050-04-09	1/4	6.4	04	11/16-16	22	29	
S050-05-09	5/16	7.9	05	11/16-16	22	29	
S050-06-09	3/8	9.5	06	11/16-16	22	29	
S050-06-11	3/8	9.5	06	13/16-16	24	30	
S050-08-11	1/2	12.7	08	13/16-16	24	32	
S050-08-13	1/2	12.7	08	1-14	30	35	
S050-08-14	1/2	12.7	08	1.3/16-12	36	37	
S050-10-13	5/8	15.9	10	1-14	30	35	
S050-10-14	5/8	15.9	10	1.3/16-12	36	34	
S050-12-13	3/4	19	12	1-14	30	37	
S050-12-14	3/4	19	12	1.3/16-12	36	35	
S050-12-15	3/4	19	12	1.7/16-12	41	41	
S050-16-15	1	25.4	16	1.7/16-12	41	39	
S050-20-21	1.1/4	31.8	20	1.11/16-12	50	40	
S050-24-32	1.1/2	38.1	24	2-12	60	41	

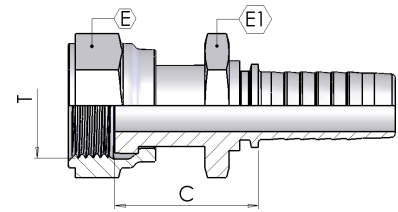
S05T**ORFS Female Back Hexagon****(ORFS)**

Product number	hose I.D.		Dimension				I.D.
	in	dash size	mm	T	E	E1	Cut-off C
S05T-04-06	1/4	04	6.4	9/16-18	17	15	30
S05T-06-09	3/8	06	9.5	11/16-16	22	17	34
S05T-08-11	1/2	08	12.7	13/16-16	24	19	37
S05T-10-13	5/8	10	15.9	1-14	30	24	41
S05T-12-14	3/4	12	19	1.3/16-12	36	30	42
S05T-16-15	1	16	25.4	1.7/16-12	41	36	50

S150

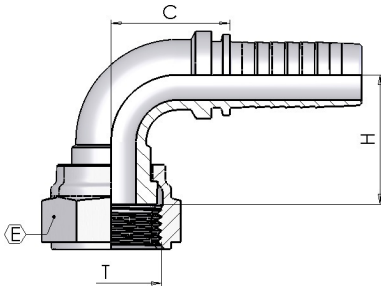

ORFS 90° Swept Elbow

(ORFS-90°)

Product number	hose I.D.		Dimension				I.D.
	in	dash size	mm	T	E	H	Cut-off C
S150-04-06	1/4	04	6.4	9/16-18	19	26	25
S150-04-09	1/4	04	6.4	11/16-16	22	23	25
S150-05-09	5/16	05	7.9	11/16-16	22	32	29
S150-06-09	3/8	06	9.5	11/16-16	22	33	33
S150-06-11	3/8	06	9.5	13/16-16	24	32	33
S150-08-11	1/2	08	12.7	13/16-16	24	36	43
S150-08-13	1/2	08	12.7	1-14	30	40	39
S150-08-14	1/2	08	12.7	1.3/16-12	36	39	42
S150-10-13	5/8	10	15.9	1-14	30	42	44
S150-10-14	5/8	10	15.9	1.3/16-12	36	39	42
S150-12-13	3/4	12	19	1-14	30	39	42
S150-12-14	3/4	12	19	1.3/16-12	36	49	57
S150-12-15	3/4	12	19	1.7/16-12	41	51	56
S150-16-15	1	16	25.4	1.7/16-12	41	62	67
S150-16-21	1	20	25.4	1.11/16-12	50	58	62
S150-20-21	1.1/4	20	31.8	1.11/16-12	50	58	63
S150-24-32	1.1/2	24	38.1	2-12	60	73	80

S15S

ORFS 90° Swept Elbow - ISO SHORT

(ORFS-90°)

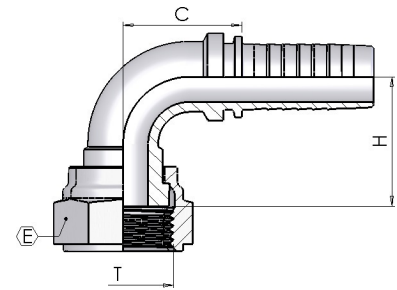

Product number	hose I.D.		Dimension				I.D.
	in	dash size	mm	T	E	H	Cut-off C
S15S-04-06	1/4	04	6.4	9/16-18	19	21	25
S15S-06-09	3/8	06	9.5	11/16-16	22	23	33
S15S-08-11	1/2	08	12.7	13/16-16	24	29	43
S15S-08-13	1/2	08	12.7	1-14	30	32	39
S15S-10-13	5/8	10	15.9	1-14	30	32	47
S15S-12-14	3/4	12	19	1.3/16-12	36	48	57
S15S-16-15	1	16	25.4	1.7/16-12	41	56	67

S250

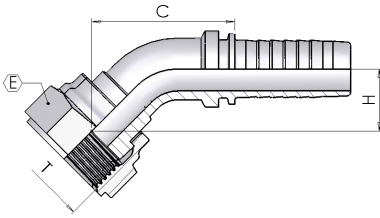

ORFS 45° Swept Elbow

(ORFS-45°)

Product number	hose I.D.		Dimension				
	in	mm	dash size	T	E	H	Cut-off C
S250-04-06	1/4	6.4	04	9/16-18	19	14	40
S250-04-09	1/4	6.4	04	11/16-16	22	14	38
S250-05-09	5/16	7.9	05	11/16-16	22	14	44
S250-06-09	3/8	9.5	06	11/16-16	22	17	52
S250-06-11	3/8	9.5	06	13/16-16	24	18	51
S250-08-11	1/2	12.7	08	13/16-16	24	20	62
S250-08-13	1/2	12.7	08	1-14	30	23	64
S250-08-14	1/2	12.7	08	1.3/16-12	36	17	44
S250-10-13	5/8	15.9	10	1-14	30	22	67
S250-10-14	5/8	15.9	10	1.3/16-12	36	18	44
S250-12-13	3/4	19	12	1-14	30	15	40
S250-12-14	3/4	19	12	1.3/16-12	36	23	84
S250-12-15	3/4	19	12	1.7/16-12	41	26	84
S250-16-15	1	25.4	16	1.7/16-12	41	27	101
S250-20-21	1.1/4	31.8	20	1.11/16-12	50	44	125
S250-24-32	1.1/2	38.1	24	2-12	60	29	78

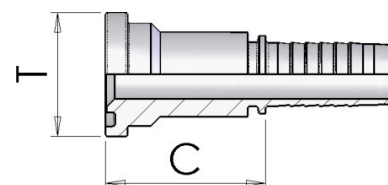
1260**Straight SAE Flange 3000 PSI****(SFL)**

Product number	hose I.D.		Dimension			
	in	mm	dash size	T Flange	mm	Cut-off C
1260-08-08	1/2	12.7	08	1/2	30,2	45
1260-08-12	1/2	12.7	08	3/4	38.1	50
1260-10-08	5/8	15.9	10	1/2	30,2	45
1260-10-10	5/8	15.9	10	5/8	34	56
1260-10-12	5/8	15.9	10	3/4	38.1	49
1260-12-12	3/4	19	12	3/4	38.1	50
1260-12-16	3/4	19	12	1	44.5	53
1260-16-16	1	25.4	16	1	44.5	54
1260-16-20	1	25.4	16	1.1/4	50.8	57
1260-20-20	1.1/4	31.8	20	1.1/4	50.8	59
1260-20-24	1.1/4	31.8	20	1.1/2	60.3	62
1260-24-24	1.1/2	38.1	24	1.1/2	60.3	62
1260-24-32	1.1/2	38.1	24	2	71.4	67
1260-32-32	2	50.8	32	2	71.4	68
1260-32-40	2	50.8	32	2.1/2	84.1	76
1260-40-40	2.1/2	63,5	40	2.1/2	84	76
1260-48-48	3	76,2	48	3	102	63

1060

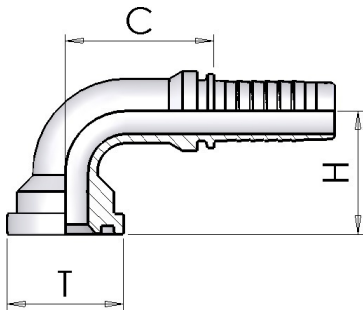

90° SAE Flange 3000 PSI

(SFL 90°)

Product number	hose I.D.		Dimension				
	in	dash size	mm	T Flange	mm	drop H	Cut-off C
1060-08-08	1/2	08	12.7	1/2	30,2	39	39
1060-08-12	1/2	08	12.7	3/4	38.1	44	42
1060-10-08	5/8	10	15.9	1/2	30,2	42	45
1060-10-12	5/8	10	15.9	3/4	38.1	47	45
1060-12-12	3/4	12	19	3/4	38.1	53	56
1060-12-16	3/4	12	19	1	44.5	58	56
1060-16-16	1	16	25.4	1	44.5	65	70
1060-16-20	1	16	25.4	1.1/4	50.8	70	67
1060-16-24	1	16	25.4	1.1/2	60.3	71	72
1060-20-16	1.1/4	20	31.8	1	44.5	73	83
1060-20-20	1.1/4	20	31.8	1.1/4	50.8	79	85
1060-20-24	1.1/4	20	31.8	1.1/2	60.3	81	85
1060-24-24	1.1/2	24	38.1	1.1/2	60.3	89	98
1060-24-32	1.1/2	24	38.1	2	71.4	90	102
1060-32-32	2	32	50.8	2	71.4	113	134

1160

45° SAE Flange 3000 PSI

(SFL 45°)

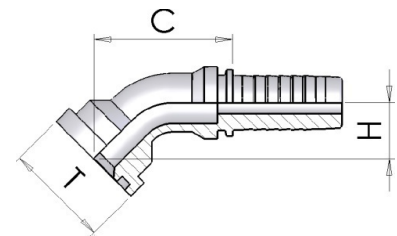

Product number	hose I.D.		Dimension				
	in	mm	dash size	T Flange	mm	H	Cut-off C
1160-08-08	1/2	12.7	08	1/2	30.2	22	62
1160-08-12	1/2	12.7	08	3/4	38.1	25	67
1160-12-12	3/4	19	12	3/4	38.1	25	69
1160-12-16	3/4	19	12	1	44.5	30	88
1160-16-16	1	25.4	16	1	44.5	29	82
1160-20-20	1.1/4	31.8	20	1.1/4	50.8	38	102
1160-20-24	1.1/4	31.8	20	1.1/2	60.3	39	106
1160-24-24	1.1/2	38.1	24	1.1/2	60.3	44	114
1160-24-32	1.1/2	38.1	24	2	71.4	40	115
1160-32-32	2	50.8	32	2	71.4	58	135

FS3L

90° SAE Flange 3000 Psi - Long Drop

(SFL 90° L)

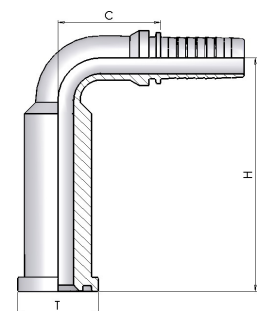

Product number	hose I.D.		Dimension				
	in	dash size	mm	T Flange	mm	drop H	Cut-off C
FS3L-12-12	3/4	12	19	3/8	38.1	123	56
FS3L-16-16	1	16	25.4	1	44.5	127	70
FS3L-20-20	1.1/4	20	31.8	1.1/4	50.8	178	85

S003

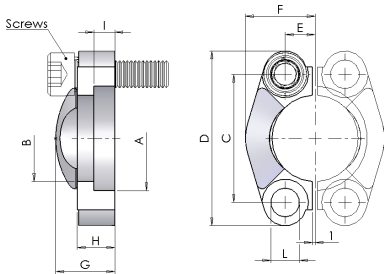

Cut Split Flanges - 3000 psi

Product number	SAE	Dimension									
	size	A	B	C	D	E	F	G	H	I	L
S003-08	1/2"	30.96	24.3	38.1	54	8.7	22.8	19	13	6.2	8.8
S003-12	3/4"	38.89	32.1	47.6	65	11.1	25.9	22	14	6.2	10.8
S003-16	1"	45.24	38.5	52.4	70	13.1	29.2	24	16	7.5	10.8
S003-20	1.1/4"	51.59	43.7	58.7	79	15.1	36.3	22	14	7.5	12
S003-24	1.1/2"	61.09	50.8	69.9	94	17.9	41.1	25	16	7.5	13.5
S003-32	2"	72.24	62.7	77.8	102	21.4	48.2	26	16	9	13.5
S003-40	2.1/2"	84.94	74.9	88.9	114	25.4	54.1	38	19	9	13.5

This product is sold in pairs

1310

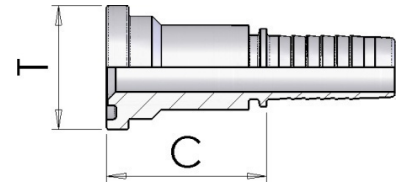
Straight SAE Flange 6000 PSI**(SFS)**

Product number	hose I.D.		Dimension			
	in	mm	dash size	T Flange	mm	Cut-off C
1310-08-08	1/2	12.7	08	1/2	31,8	46
1310-08-12	1/2	12.7	08	3/4	41.3	53
1310-10-08	5/8	15.9	10	1/2	31,8	46
1310-10-12	5/8	15.9	10	3/4	41.3	53
1310-12-12	3/4	19	12	3/4	41.3	54
1310-12-16	3/4	19	12	1	47.6	60
1310-16-12	1	25.4	16	3/4	41.3	55
1310-16-16	1	25.4	16	1	47.6	61
1310-16-20	1	25.4	16	1.1/4	54	68
1310-20-20	1.1/4	31.8	20	1.1/4	54	70
1310-20-24	1.1/4	31.8	20	1.1/2	63.5	76
1310-24-24	1.1/2	38.1	24	1.1/2	63.5	76
1310-24-32	1.1/2	38.1	24	2	79.4	85
1310-32-32	2	50.8	32	2	79.4	85

1110

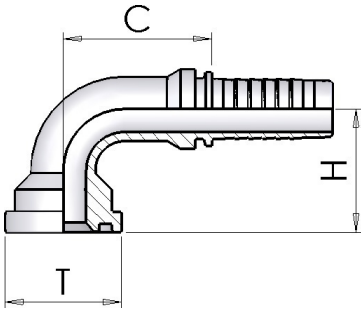

90° SAE Flange 6000 PSI

(SFS 90°)

Product number	hose I.D.		Dimension				
	in	mm	dash size	T Flange	mm	drop H	Cut-off C
1110-08-08	1/2	12.7	08	1/2	31.8	39	39
1110-08-12	1/2	12.7	08	3/4	41.3	48	39
1110-10-08	5/8	15.9	10	1/2	31.8	42	45
1110-10-12	5/8	15.9	10	3/4	41.3	52	44
1110-12-12	3/4	19	12	3/4	41.3	55	56
1110-12-16	3/4	19	12	1	47.6	63	56
1110-16-12	1	25.4	16	3/4	41.3	64	68
1110-16-16	1	25.4	16	1	47.6	69	70
1110-16-20	1	25.4	16	1.1/4	54	74	71
1110-20-20	1.1/4	31.8	20	1.1/4	54	83	97
1110-20-24	1.1/4	31.8	20	1.1/2	63.5	93	97
1110-24-24	1.1/2	38.1	24	1.1/2	63.5	103	100
1110-32-32	2	50.8	32	2	79.4	136	125

1210

45° SAE Flange 6000 PSI

(SFS 45°)

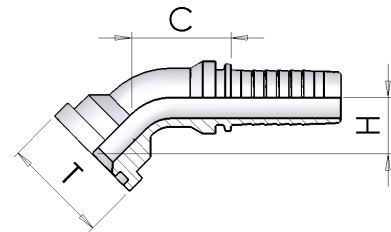

Product number	hose I.D.		Dimension				
	in	mm	dash size	T Flange	mm	drop H	Cut-off C
1210-08-08	1/2	12.7	08	1/2	31.8	22	62
1210-08-12	1/2	12.7	08	3/4	41.3	28	69
1210-10-08	5/8	15.9	10	1/2	31.8	21	66
1210-10-12	5/8	15.9	10	3/4	41.3	27	75
1210-12-12	3/4	19	12	3/4	41.3	28	74
1210-12-16	3/4	19	12	1	47.6	32	90
1210-16-12	1	25.4	16	3/4	41.3	29	94
1210-16-16	1	25.4	16	1	47.6	34	86
1210-16-20	1	25.4	16	1.1/4	54	37	90
1210-20-20	1.1/4	31.8	20	1.1/4	54	41	111
1210-20-24	1.1/4	31.8	20	1.1/2	63.5	48	118
1210-24-24	1.1/2	38.1	24	1.1/2	63.5	50	122
1210-32-32	2	50.8	32	2	79.4	58	151

FS6L

90° SAE Flange 6000 Psi - Long Drop

(SFS 90° L)

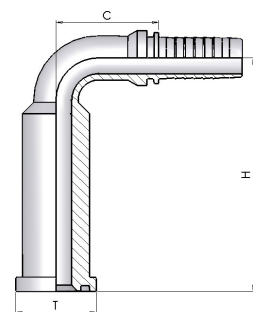

Product number	hose I.D.		Dimension				
	in	mm	dash size	T Flange	mm	drop H	Cut-off C
FS6L-08-08	1/2	12.7	08	1/2	32	75	40
FS6L-12-12	3/4	19	12	3/4	41.3	126	56
FS6L-16-16	1	25.4	16	1	47.6	132	70
FS6L-20-20	1.1/4	31.8	20	1.1/4	54	185	82

S006

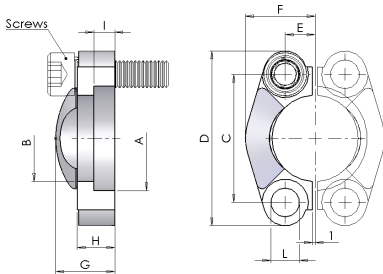

Cut Split Flanges - 6000 psi

Product number	SAE	Dimension									
	size	A	B	C	D	E	F	G	H	I	L
S006-08	1/2"	32.54	24.6	40.5	56	9.1	23.6	22	16	7.2	8.8
S006-12	3/4"	42.06	32.5	50.8	71	11.9	30	28	19	8.3	11
S006-16	1"	48.41	38.9	57.2	81	13.9	34.8	33	24	9	13
S006-20	1 1/4"	54.76	44.5	66.7	95	15.9	38.6	38	27	9.8	15
S006-24	1 1/2"	64.29	51.6	79.4	113	18.3	47.5	43	30	12.1	17
S006-32	2"	80.16	67.6	96.8	133	22.2	56.9	52	37	12.1	21

This product is sold in pairs

130S

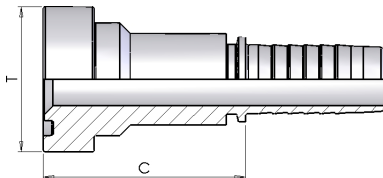

Straight 'CAT' Flange

(SFC)

Product number	hose I.D.	I.D.	Dimension			
	in	mm	dash size	T Flange	mm	Cut-off C
130S-12-12	3/4	19	12	3/4	41.3	58
130S-12-16	3/4	19	12	1	47.6	64
130S-16-16	1	25.4	16	1	47.6	65
130S-16-20	1	25.4	16	1 1/4	54	73
130S-20-20	1 1/4	31.8	20	1 1/4	54	74
130S-24-24	1 1/2	38.1	24	1 1/2	63.5	80

110S

90° 'CAT' Flange

(SFC 90°)

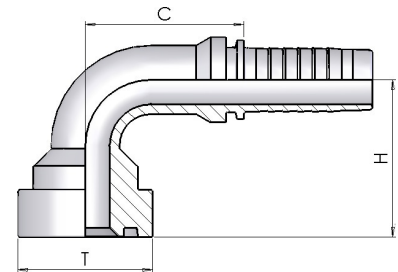

Product number	hose I.D. I.D.		Dimension				
	in	mm	dash size	T Flange	mm	H	Cut-off C
110S-12-12	3/4	19	12	3/4	41.3	62	56
110S-12-16	3/4	19	12	1	47.6	65	56
110S-16-16	1	25.4	16	1	47.6	74	78
110S-16-20	1	25.4	16	1.1/4	54	80	78
110S-20-20	1.1/4	31.8	20	1.1/4	54	90	97
110S-20-24	1.1/4	31.8	20	1.1/2	63.5	95	96
110S-24-24	1.1/2	38.1	24	1.1/2	63.5	104	115

120S

45° 'CAT' Flange

(SFC 45°)

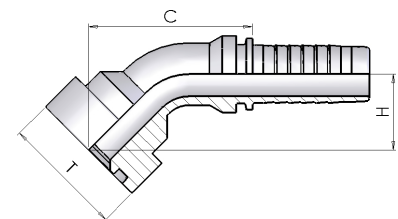

Product number	hose I.D. I.D.		Dimension				
	in	mm	dash size	T Flange	mm	H	Cut-off C
120S-12-12	3/4	19	12	3/4	41.3	32	88
120S-12-16	3/4	19	12	1	47.6	37	93
120S-16-16	1	25.4	16	1	47.6	37	90
120S-16-20	1	25.4	16	1.1/4	54	44	122
120S-20-20	1.1/4	31.8	20	1.1/4	54	43	114
120S-20-24	1.1/4	31.8	20	1.1/2	63.5	48	119
120S-24-24	1.1/2	38.1	24	1.1/2	63.5	52	172

1250

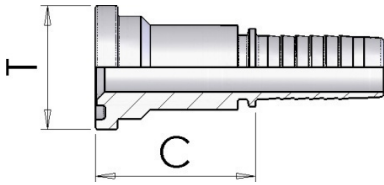

Komatsu Flange - Straight

(JIS-KF)

Product number	hose I.D.		Dimension			
	in	mm	dash size	T Flange	mm	Cut-off C
1250-10-10	5/8	15.9	10	5/8	34	56

1050

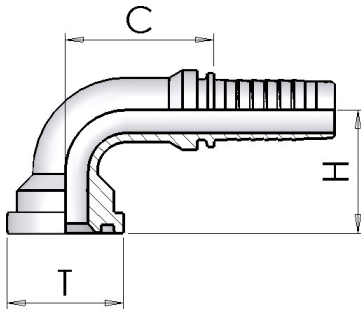

Komatsu Flange 90°

(JIS-KF)

Product number	hose I.D.		Dimension				
	in	dash size	mm	T Flange	mm	drop H	Cut-off C
1050-10-10	5/8	10	15.9	5/8	34	47	58

1150

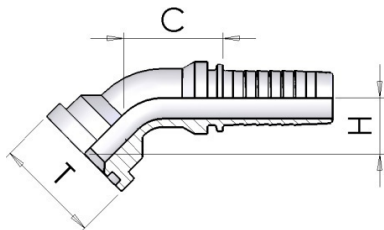

Komatsu Flange 45°

(JIS-KF)

Product number	hose I.D.		Dimension				
	in	dash size	mm	T Flange	mm	drop H	Cut-off C
1150-10-10	5/8	10	15.9	5/8	34	54	23

0940

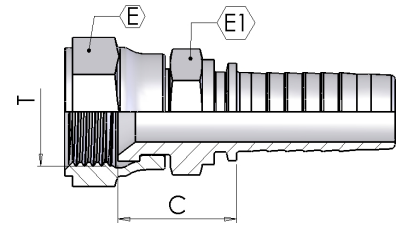
JIS Female 60° Cone (Komatsu)**(JIS-K)**

Product number	hose I.D.		I.D.	Dimension			
	in	mm		dash size	T	E	E1
0940-04-14	1/4	6.4	04	M14x1,5	19	17	22
0940-05-16	5/16	7.9	05	M16x1,5	22	17	22
0940-06-14	3/8	9.5	06	M14x1,5	19	17	22
0940-06-16	3/8	9.5	06	M16x1,5	22	19	22
0940-06-18	3/8	9.5	06	M18x1,5	24	19	21
0940-08-22	1/2	12.7	08	M22x1,5	27	22	27
0940-08-24	1/2	12.7	08	M24x1,5	30	27	25
0940-10-24	5/8	15.9	10	M24x1,5	30	27	26
0940-12-30	3/4	19	12	M30x1,5	36	30	30
0940-16-33	1	25.4	16	M33x1,5	41	36	33
0940-20-36	1.1/4	31.8	20	M36x1,5	46	46	37
0940-24-42	1.1/2	38.1	24	M42x1,5	50	50	38

0990S

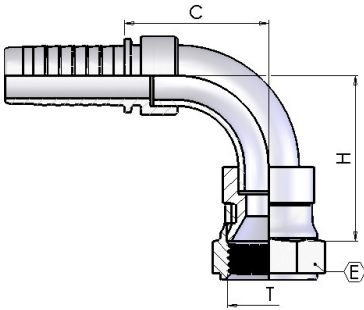

90° JIS Swept Elbow (Komatsu) - welded

(JIS-K 90°)

Product number	hose I.D.		dash size	Dimension			
	in	mm		T	E	H	Cut-off C
0990S04-14	1/4	6.4	04	M14x1,5	19	35	38
0990S05-16	5/16	7.9	05	M16x1,5	22	30	27
0990S06-14	3/8	9.5	06	M14x1,5	19	33	31
0990S06-18	3/8	9.5	06	M18x1,5	24	33	31
0990S08-22	1/2	12.7	08	M22x1,5	27	39	33
0990S10-24	5/8	15.9	10	M24x1,5	30	48	42
0990S12-30	3/4	19	12	M30x1,5	36	43	48
0990S16-33	1	25.4	16	M33x1,5	41	62	57

0930

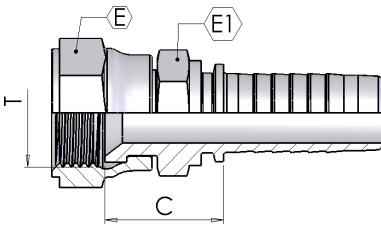

JIS Female 60° cone (Toyota)

(JIS-T)

Product number	hose I.D.		dash size	Dimension			
	in	mm		T	E	E1	Cut-off C
0930-04-04	1/4	6.4	04	1/4-19	19	17	20
0930-06-06	3/8	9.5	06	3/8-19	22	19	22
0930-08-08	1/2	12.7	08	1/2-14	27	22	26
0930-12-12	3/4	19	12	3/4-14	32	30	29
0930-16-16	1	25.4	16	1-11	38	36	31
0930-20-20	1,1/4	31.8	20	1,1/4-11	50	46	35
0930-24-24	1,1/2	38.1	24	1,1/2-11	55	50	28

0980S

90° JIS Swept Elbow (Toyota) - welded

(JIS-T 90°)

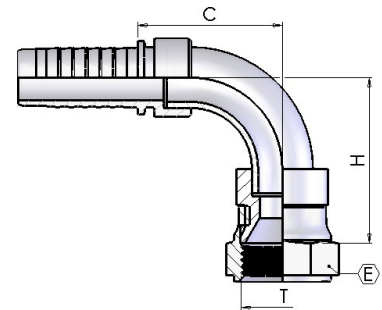

Product number	hose I.D.		I.D.	Dimension				Cut-off C
	in	mm		dash size	T	E	H	
0980S04-04	1/4	6.4	04	1/4-19	19	35	38	
0980S06-06	3/8	9.5	06	3/8-19	22	30	27	
0980S08-08	1/2	12.7	08	1/2-14	27	39	33	
0980S12-12	3/4	19	12	3/4-14	32	55	48	
0980S16-16	1	25.4	16	1-11	38	62	57	

0920

JIS Female 60° cone (Nissan)

(JIS-N)

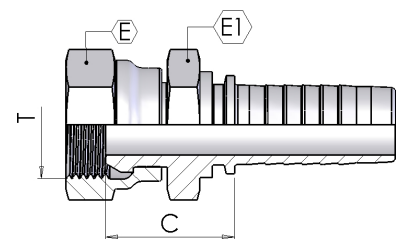

Product number	hose I.D.		I.D.	Dimension				Cut-off C
	in	mm		dash size	T	E	E1	
0920-04-04	1/4	6.4	04	1/4-19	19	19	23	
0920-06-06	3/8	9.5	06	3/8-19	22	22	28	
0920-08-08	1/2	12.7	08	1/2-14	27	27	27	

0030

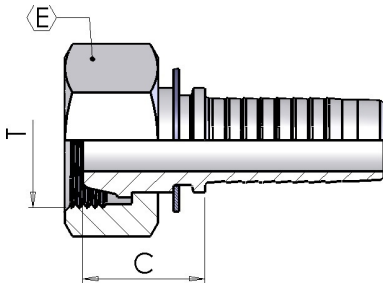

Metric Female 24° Cone French Type

(DKF)

Product number	hose I.D.		I.D.	Dimension		
	in	mm		dash size	T	E
0030-05-20	5/16	7.9	05	M20-1.5	24	25
0030-06-20	3/8	9.5	06	M20-1.5	24	26
0030-08-24	1/2	12.7	08	M24-1.5	30	28
0030-10-30	5/8	15.9	10	M30-1.5	36	25
0030-12-30	3/4	19	12	M30-1.5	36	26
0030-12-36	3/4	19	12	M36-1.5	46	29
0030-16-45	1	25.4	16	M45-1.5	55	30
0030-20-52	1.1/4	31.8	20	M52-1.5	65	34

FK50

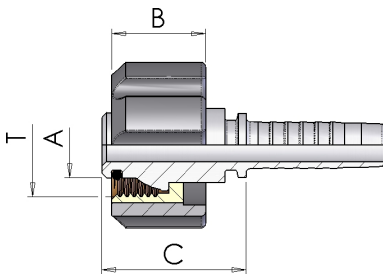

K' Female

Product number	hose I.D.		Dimension				I.D.
	in	dash size	mm	T	A	B	
FK50-04-22	1/4	04	6.4	M22-1.5	14	20	31
FK50-05-22	5/16	05	7.9	M22-1.5	14	20	31
FK50-06-22	3/8	06	9.5	M22-1.5	14	20	31
FK50-04022	1/4	04	6.4	M22-1.5	14	27	31
FK50-05022	5/16	05	7.9	M22-1.5	14	27	31
FK50-06022	3/8	06	9.5	M22-1.5	14	27	31

FN50

'K' Male (for gun) - Diameter 10

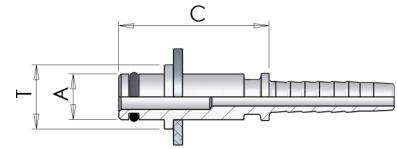

Product number	hose I.D.		Dimension		
	in	mm	dash size	A	C
FN50-04-22	1/4	6.4	04	10	33
FN50-05-22	5/16	7.9	05	10	33
FN50-06-22	3/8	9.5	06	10	33

FN51

'K' Male (for gun) - Diameter 11

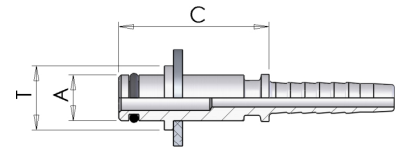

Product number	hose I.D.		Dimension		
	in	mm	dash size	A	C
FN51-04-22	1/4	6.4	04	11	33
FN51-05-22	5/16	7.9	05	11	33

1400

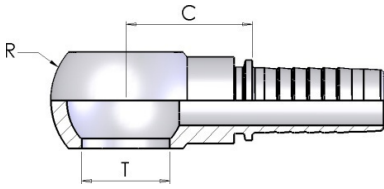

BSP Banjo

Product number	hose I.D.		Dimension				
	in	mm	dash size	hole T	mm	R	Cut-off C
1400-03-02	3/16	4.8	03	1/8-28	10.2	17	19
1400-03-04	3/16	4.8	03	1/4-19	13.3	24	26
1400-04-02	1/4	6.4	04	1/8-28	10.2	17	25
1400-04-04	1/4	6.4	04	1/4-19	13.3	24	26
1400-04-06	1/4	6.4	04	3/8-19	17	28	26
1400-05-04	5/16	7.9	05	1/4-19	13.3	24	26
1400-05-06	5/16	7.9	05	3/8-19	17	28	26
1400-06-04	3/8	9.5	06	1/4-19	13.3	24	26
1400-06-06	3/8	9.5	06	3/8-19	17	28	26
1400-06-08	3/8	9.5	06	1/2-14	21.2	36	31
1400-08-06	1/2	12.7	08	3/8-19	17	28	27
1400-08-08	1/2	12.7	08	1/2-14	21.2	36	31
1400-08-12	1/2	12.7	08	3/4-14	26.5	45	38
1400-10-12	5/8	15.9	10	3/4-14	26.5	45	38
1400-12-12	3/4	19	12	3/4-14	26.5	45	38
1400-12-16	3/4	19	12	1-11	33.5	58	49
1400-16-16	1	25.4	16	1-11	33.5	58	50

1600

Double BSP Perforded Bolt

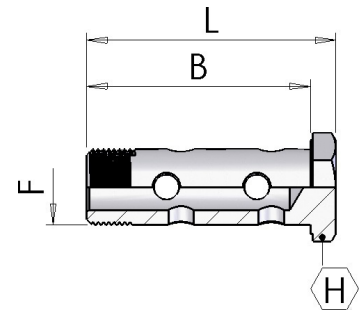

Product number	Dimension			
	F	B	L	H
1600-04-04	1/4-19	43	49	19
1600-06-06	3/8-19	49	57	22
1600-08-08	1/2-14	62	70	27
1600-12-12	3/4-14	78	87	32
1600-16-16	1-11	98	109	41

1600-00

BSP Perforded Bolt

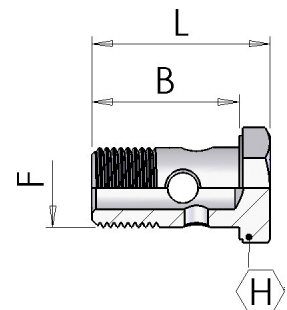

Product number	Dimension			
	F	B	L	H
1600-00-02	1/8-28	19	24	14
1600-00-04	1/4-19	29	34	19
1600-00-06	3/8-19	33	41	22
1600-00-08	1/2-14	38	46	27
1600-00-12	3/4-14	47	56	32
1600-00-16	1-11	58	69	41

1350

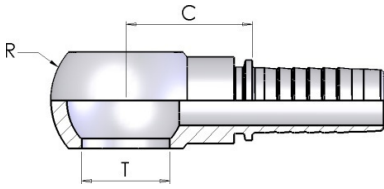

Metric Banjo

Product number	hose I.D.		Dimension				
	in	mm	dash size	hole T	mm	R	Cut-off C
1350-03-10	3/16	4.8	03	M10-1	10.2	17	25
1350-03-12	3/16	4.8	03	M12-1.5	12.2	20	22
1350-04-10	1/4	6.4	04	M10-1	10.2	17	25
1350-04-12	1/4	6.4	04	M12-1.5	12.2	20	22
1350-04-14	1/4	6.4	04	M14-1.5	14.2	24	26
1350-05-14	5/16	7.9	05	M14-1.5	14.2	24	26
1350-05-16	5/16	7.9	05	M16-1.5	16.2	28	26
1350-05-18	5/16	7.9	05	M18-1.5	18.2	32	29
1350-06-14	3/8	9.5	06	M14-1.5	14.2	24	26
1350-06-16	3/8	9.5	06	M16-1.5	16.2	28	26
1350-06-18	3/8	9.5	06	M18-1.5	18.2	32	29
1350-06-22	3/8	9.5	06	M22-1.5	22.2	36	31
1350-08-16	1/2	12.7	08	M16-1.5	16.2	28	27
1350-08-18	1/2	12.7	08	M18-1.5	18.2	32	29
1350-08-22	1/2	12.7	08	M22-1.5	22.2	36	31
1350-10-22	5/8	15.9	10	M22-1.5	22.2	36	31
1350-10-26	5/8	15.9	10	M26-1.5	26.5	45	38
1350-12-22	3/4	19	12	M22-1.5	22.2	36	32
1350-12-26	3/4	19	12	M26-1.5	26.2	46	38
1350-16-30	1	25.4	16	M30-2	30.2	54	45

1650

Metric perforated bolt

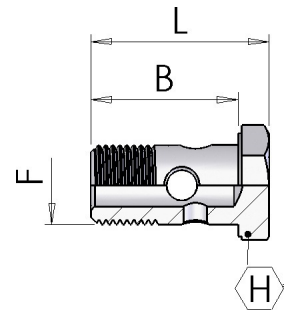

Product number	Dimension			
	F	B	L	H
1650-00-10	M10-1	19	24	14
1650-00-12	M12-1.5	26	31	17
1650-00-14	M14-1.5	29	34	19
1650-00-16	M16-1.5	33	41	22
1650-00-18	M18-1.5	37	44	24
1650-00-22	M22-1.5	38	46	27
1650-00-26	M26-1.5	47	56	32
1650-00-30	M30-1.5	58	68	36

D050

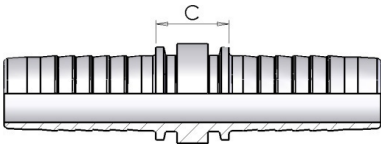

Hose Junction

Product number	hose I.D.		I.D.		Dimension	
	in	mm	dash size	Cut-off C		
D050-03	3/16	4.8	03	17		
D050-04	1/4	6.4	04	22		
D050-05	5/16	7.9	05	22		
D050-06	3/8	9.5	06	22		
D050-08	1/2	12.7	08	23		
D050-10	5/8	15.9	10	18		
D050-12	3/4	19	12	19		
D050-16	1	25.4	16	21		
D050-20	1.1/4	31.8	20	24		
D050-24	1.1/2	38.1	24	24		
D050-32	2	50.8	32	26		

Weldable Fitting

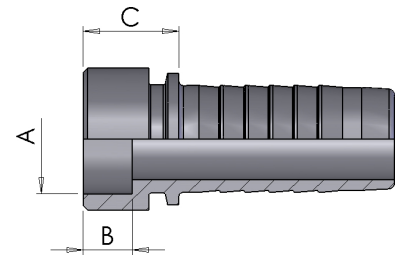

Product number	hose I.D.	I.D.	Dimension			
	in	mm	dash size	A	B	Cut-off C
GS00-03-08	3/16	4,8	03	08	6	12
GS00-04-06	1/4	6.4	04	06	6	14
GS00-04-08	1/4	6.4	04	08	6	14
GS00-04-10	1/4	6.4	04	10	6	15
GS00-04-12	1/4	6.4	04	12	7	17
GS00-05-08	5/16	7,9	05	08	6	14
GS00-05-10	5/16	7,9	05	10	6	14
GS00-05-12	5/16	7,9	05	12	6	14
GS00-06-06	3/8	9.5	06	06	6	15
GS00-06-08	3/8	9.5	06	08	6	15
GS00-06-10	3/8	9.5	06	10	6	14
GS00-06-12	3/8	9.5	06	12	7	15
GS00-06-15	3/8	9.5	06	15	7	14
GS00-08-12	1/2	12.7	08	12	7	15
GS00-08-14	1/2	12.7	08	14	8	15
GS00-08-15	1/2	12.7	08	15	7	15
GS00-08-16	1/2	12.7	08	16	7	15
GS00-08-20	1/2	12.7	08	20	9	18
GS00-10-16	5/8	15.9	10	16	8	16
GS00-10-18	5/8	15.9	10	18	8	16
GS00-10-20	5/8	15.9	10	20	9	18
GS00-12-16	3/4	19	12	16	8	16
GS00-12-18	3/4	19	12	18	8	16
GS00-12-20	3/4	19	12	20	9	18
GS00-12-22	3/4	19	12	22	9	18
GS00-12-25	3/4	19	12	25	9	19
GS00-16-25	1	25.4	16	25	9	19
GS00-16-30	1	25.4	16	30	9	20
GS00-20-35	1.1/4	31.8	20	35	11	23

without zinc plating

N Tail

in!



0NI4



Swaged Ferrule 4WS (no skive)

90

0NI6



Swaged Ferrule (no skive)

90

0370N



NPTF Male 60° cone

91

0350N



BSP Male Parallel 60° cone

91

0050N 0051N



BSP Female 60° Cone

92

0150N 0151N



BSP 90° Swept elbow 60° cone

93

0250N 0251N



BSP 45° Swept Elbow 60° Cone

94

0500N



Metric Male 24° Seat Light

95

0085N



Metric Female 24° Seat Light

96

0185N



90° Metric Swept Elbow 24° Seat Light

96

0285N



45° Metric Swept Elbow 24° Seat Light

97

0450N



Metric Male 24° Seat Heavy

97

0084N



Metric Female 24° Seat Heavy

98

0184N



90° Metric Swept Elbow 24° Seat Heavy

98

0284N



45° Metric Swept Elbow 24° Seat Heavy

99

0850N



JIC Male 74° cone

100

0900N 0901N



JIC Female 74° Cone-
Double Hexagon

101

0950N 0951N



JIC 90° Swept Elbow 74°
cone

102

095SN



JIC 90° Swept Elbow 74°
cone - ISO SHORT

102

1000N 1001N



JIC 45° Swept Elbow 74°

103

S350N



ORFS Male

104

S05TN



ORFS Female Back
Hexagon

104

S150N



ORFS 90° Swept Elbow

105

S15SN



ORFS 90° Swept Elbow -
ISO SHORT

105

S250N



ORFS 45° Swept Elbow

106

1250N



Straight SAE Flange
3000 PSI

106

1050N



90° SAE Flange 3000 PSI

107

1150N



45° SAE Flange 3000 PSI

107

1300N



Straight SAE Flange
6000 PSI

108

1100N



90° SAE Flange 6000 PSI

108

1200N



45° SAE Flange 6000 PSI

109

130SN



Straight 'CAT' Flange

109

110SN



90° 'CAT' Flange

110

120SN



45° 'CAT' Flange

111

ONI4

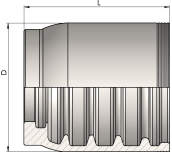

Swaged Ferrule 4WS (no skive)

Product number	hose I.D.	I.D.	Dimension		skive	valid for
	in	mm	D	L	Length	-
ONI4-06	3/8	9.5	30.5	37	NO	SR-ISO
ONI4-08	1/2	12.7	33,5	37,5	NO	SR-ISO
ONI4-10	5/8	15.9	37.5	46	NO	SR-ISO
ONI4-12	3/4	19	44.5	50.5	NO	SR-ISO
ONI4-16	1	25.4	52.5	59.5	NO	SR-ISO
ONI4-20	1.1/4	31.8	60.5	70	NO	SR-ISO
ONI4-24	1.1/2	38.1	69.5	80	NO	SR-ISO

ONI6

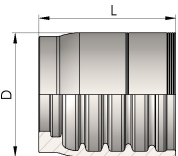

Swaged Ferrule (no skive)

Product number	hose I.D.	I.D.	Dimension		skive	valid for
	in	mm	D	L	Length	-
ONI6-20	1.1/4	31.8	63.5	70	NO	SR-ISO
ONI6-24	1.1/2	38.1	72.5	80	NO	SR-ISO

0370N

NPTF Male 60° cone

(AGN)

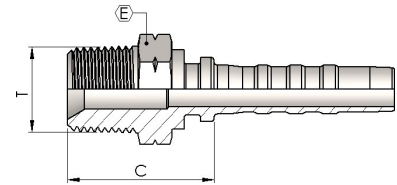

Product number	hose I.D.		Dimension			
	in	mm	dash size	Cut-off C	T	E
0370N06-06	3/8	9.5	06	30	3/8-18	19
0370N06-08	3/8	9.5	06	36	1/2-14	22
0370N08-08	1/2	12.7	08	36	1/2-14	22
0370N12-12	3/4	19	12	39	3/4-14	27
0370N16-16	1	25.4	16	46	1-11.1/2	36
0370N20-20	1.1/4	31.8	20	50	1.1/4-11.1/2	46
0370N24-24	1.1/2	38.1	24	54	1.1/2-11.1/2	50

0350N

BSP Male Parallel 60° cone

(AGR)

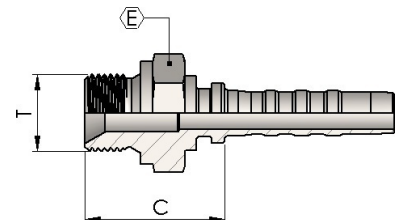

Product number	hose I.D.		Dimension				I.D.
	in	dash size	mm	T	E	Cut-off C	
0350N06-06	3/8	06	9.5	3/8-19	22	31	
0350N06-08	3/8	06	9.5	1/2-14	27	34	
0350N08-08	1/2	08	12.7	1/2-14	27	34	
0350N10-10	5/8	10	15.9	5/8-14	30	37	
0350N10-12	5/8	10	15.9	3/4-14	32	37	
0350N12-12	3/4	12	19	3/4-14	32	38	
0350N12-16	3/4	12	19	1-11	41	41	
0350N16-16	1	16	25.4	1-11	41	42	
0350N16-20	1	16	25.4	1.1/4-11	50	46	
0350N20-20	1.1/4	20	31.8	1.1/4-11	50	48	
0350N24-24	1.1/2	24	38.1	1.1/2-11	55	51	

0050N 0051N

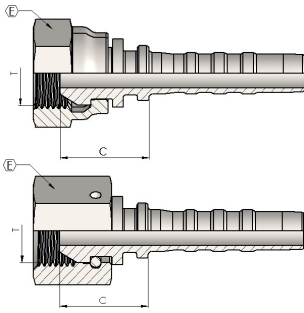

BSP Female 60° Cone

(DKR)

Product number	hose I.D.		Dimension			
	in	mm	dash size	Thread T	hex E	Cut-off C
0051N06-06	3/8	9.5	06	3/8-19	22	21
0051N06-08	3/8	9.5	06	1/2-14	23	24
0051N08-08	1/2	12.7	08	1/2-14	27	24
0051N10-10	5/8	15.9	10	5/8-14	30	22
0050N10-12	5/8	15.9	10	3/4-14	32	27
0050N12-12	3/4	19	12	3/4-14	32	27
0050N12-16	3/4	19	12	1-11	41	28
0050N16-16	1	25.4	16	1-11	41	30
0050N20-20	1.1/4	31.8	20	1.1/4-11	50	34
0050N20-24	1.1/4	31.8	20	1.1/2-11	55	36
0050N24-24	1.1/2	38.1	24	1.1/2-11	55	39

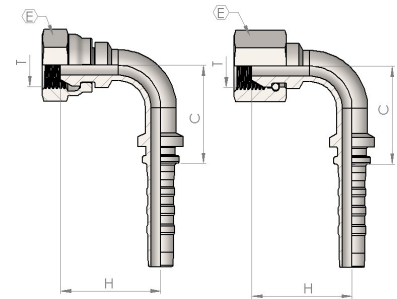
0150N 0151N**BSP 90° Swept elbow 60° cone**

Product number	hose I.D.		dash size	Dimension			
	in	mm		T	E	H	Cut-off C
0151N06-06	3/8	9.5	06	3/8-19	22	35	33
0151N06-08	3/8	9.5	06	1/2-14	27	40	31
0151N08-08	1/2	12.7	08	1/2-14	27	41	39
0151N10-10	5/8	15.9	10	5/8-14	30	43	44
0150N10-12	5/8	15.9	10	3/4-14	32	50	45
0150N12-12	3/4	19	12	3/4-14	32	57	58
0150N16-16	1	25.4	16	1-11	41	70	75
0150N16-20	1	25.4	16	1.1/4-11	50	76	77
0150N20-20	1.1/4	31.8	20	1.1/4-11	50	84	98
0150N24-24	1.1/2	38.1	24	1.1/2-11	55	104	110

0250N 0251N

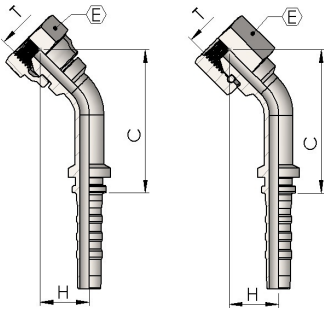

BSP 45° Swept Elbow 60° Cone

(DKR-45°)

Product number	hose I.D.		Dimension				
	in	mm	dash size	T	E	H	C
0251N06-06	3/8	9.5	06	3/8-19	22	19	54
0251N06-08	3/8	9.5	06	1/2-14	27	21	57
0251N08-08	1/2	12.7	08	1/2-14	27	24	66
0251N10-10	5/8	15.9	10	5/8-14	30	23	70
0250N10-12	5/8	15.9	10	3/4-14	32	27	74
0250N12-12	3/4	19	12	3/4-14	32	28	88
0250N16-16	1	25.4	16	1-11	41	38	116
0250N16-20	1	25.4	16	1.1/4-11	50	33	70
0250N20-20	1.1/4	31.8	20	1.1/4-11	50	41	103
0250N24-24	1.1/2	38.1	24	1.1/2-11	55	54	172

0500N

Metric Male 24° Seat Light

(CEL)

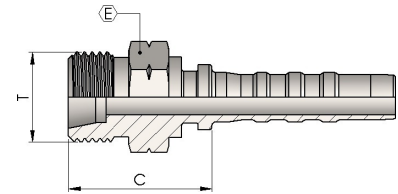

Product number	hose I.D.		Dimension				I.D.
	in	dash size	mm	T	erm.	E	Cut-off C
0500N06-16	3/8	06	9.5	M16-1.5	10	17	23
0500N06-18	3/8	06	9.5	M18-1.5	12	19	24
0500N06-22	3/8	06	9.5	M22-1.5	15	22	25
0500N08-18	1/2	08	12.7	M18-1.5	12	19	25
0500N08-22	1/2	08	12.7	M22-1.5	15	22	26
0500N08-26	1/2	08	12.7	M26-1.5	18	27	27
0500N10-22	5/8	10	15.9	M22-1.5	15	22	26
0500N10-26	5/8	10	15.9	M26-1.5	18	27	27
0500N10-30	5/8	10	15.9	M30-2	22	30	32
0500N12-26	3/4	12	19	M26-1.5	18	27	28
0500N12-30	3/4	12	19	M30-2	22	30	33
0500N16-36	1	16	25.4	M36-2	28	36	32
0500N20-45	1.1/4	20	31.8	M45-2	35	46	36
0500N24-52	1.1/2	24	38.1	M52-2	42	55	38

0085N

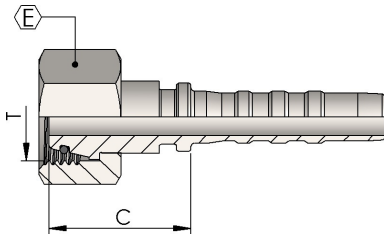

Metric Female 24° Seat Light

(DKOL)

Product number	hose I.D.		Dimension					I.D.
	in	dash size	mm	T	erm.	E	Cut-off C	
0085N06-18	3/8	06	9.5	M18-1.5	12	22	27	
0085N08-22	1/2	08	12.7	M22-1.5	15	27	30	
0085N10-26	5/8	10	15.9	M26-1.5	18	32	31	
0085N12-30	3/4	12	19	M30-2	22	36	31	
0085N16-36	1	16	25.4	M36-2	28	41	32	
0085N20-45	1.1/4	20	31.8	M45-2	35	50	43	
0085N24-52	1.1/2	24	38.1	M52-2	42	60	46	

0185N

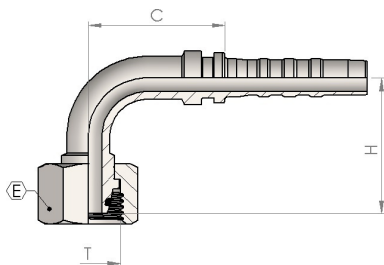

90° Metric Swept Elbow 24° Seat Light

(DKOL-90°)

Product number	hose I.D.		Dimension					
	in	mm	dash size	T	erm.	E	H	Cut-off C
0185N06-18	3/8	9.5	06	M18-1.5	12	22	33	34
0185N08-22	1/2	12.7	08	M22-1.5	15	27	41	41
0185N10-26	5/8	15.9	10	M26-1.5	18	32	44	44
0185N12-30	3/4	19	12	M30-2	22	36	52	58
0185N16-36	1	25.4	16	M36-2	28	41	62	72
0185N20-45	1.1/4	31.8	20	M45-2	35	50	73	63
0185N24-52	1.1/2	38.1	24	M52-2	42	60	83	81

0285N

45° Metric Swept Elbow 24° Seat Light

(DKOL-45°)

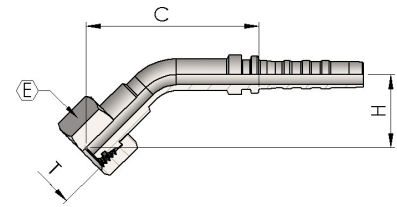

Product number	hose I.D.		Dimension					
	in	mm	dash size	T	erm.	E	H	Cut-off C
0285N06-18	3/8	9.5	06	M18-1.5	12	22	19	52
0285N08-22	1/2	12.7	08	M22-1.5	15	27	21	63
0285N10-26	5/8	15.9	10	M26-1.5	18	32	23	68
0285N16-36	1	25.4	16	M36-2	28	41	29	104
0285N20-45	1.1/4	31.8	20	M45-2	35	50	34	72
0285N24-52	1.1/2	38.1	24	M52-2	42	60	36	85

0450N

Metric Male 24° Seat Heavy

(CES)

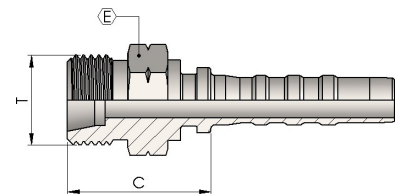

Product number	hose I.D.		Dimension				
	in	mm	dash size	T	erm.	E	Cut-off C
0450N06-20	3/8	9.5	06	M20-1.5	12	22	31
0450N08-24	1/2	12.7	08	M24-1.5	16	24	33
0450N10-30	5/8	15.9	10	M30-2	20	30	36
0450N12-30	3/4	19	12	M30-2	20	30	37
0450N12-36	3/4	19	12	M36-2	25	36	39
0450N16-42	1	25.4	16	M42-2	30	46	44
0450N20-52	1.1/4	31.8	20	M52-2	38	55	48
0450N24-52	1.1/2	38.1	24	M52-2	38	55	50

0084N

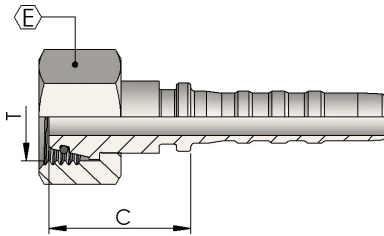

Metric Female 24° Seat Heavy

(DKOS)

Product number	hose I.D.		Dimension				
	in	mm	dash size	T	erm.	E	Cut-off C
0084N06-20	3/8	9.5	06	M20-1.5	12	24	25
0084N08-24	1/2	12.7	08	M24-1.5	16	30	29
0084N10-30	5/8	15.9	10	M30-2	20	34	34
0084N12-30	3/4	19	12	M30-2	20	36	36
0084N12-36	3/4	19	12	M36-2	25	46	41
0084N16-36	1	25.4	16	M36-2	25	46	42
0084N16-42	1	25.4	16	M42-2	30	50	44
0084N20-52	1.1/4	31.8	20	M52-2	38	60	46
0084N24-52	1.1/2	38.1	24	M52-2	38	60	52

0184N

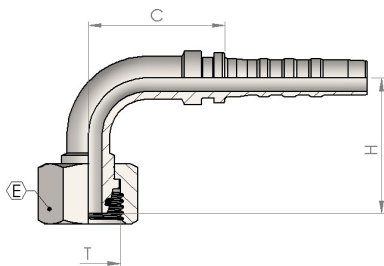

90° Metric Swept Elbow 24° Seat Heavy

(DKOS-90°)

Product number	hose I.D.		Dimension					
	in	mm	dash size	T	erm.	E	H	Cut-off C
0184N06-20	3/8	9.5	06	M20-1.5	12	24	34	34
0184N08-24	1/2	12.7	08	M24-1.5	16	30	41	40
0184N10-30	5/8	15.9	10	M30-2	20	36	50	46
0184N12-30	3/4	19	12	M30-2	20	36	56	58
0184N12-36	3/4	19	12	M36-2	25	46	57	59
0184N16-36	1	25.4	16	M36-2	25	46	67	77
0184N16-42	1	25.4	16	M42-2	30	50	67	72
0184N20-52	1.1/4	31.8	20	M52-2	38	60	82	84
0184N24-52	1.1/2	38.1	24	M52-2	38	60	105	105

0284N

45° Metric Swept Elbow 24° Seat Heavy

(DKOS-45°)

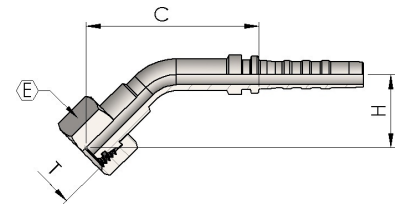

Product number	hose I.D.		I.D.	Dimension				
	in	mm		dash size	T	erm.	E	H
0284N06-20	3/8	9.5	06	M20-1.5	12	24	18	53
0284N08-24	1/2	12.7	08	M24-1.5	16	30	21	63
0284N10-30	5/8	15.9	10	M30-2	20	36	29	74
0284N12-30	3/4	19	12	M30-2	20	36	30	87
0284N12-36	3/4	19	12	M36-2	25	46	29	56
0284N16-36	1	25.4	16	M36-2	25	46	34	105
0284N16-42	1	25.4	16	M42-2	30	50	30	85
0284N20-52	1.1/4	31.8	20	M52-2	38	60	39	105
0284N24-52	1.1/2	38.1	24	M52-2	38	60	53	129

0850N

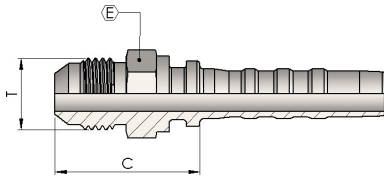

JIC Male 74° cone

(AGJ)

Product number	hose I.D.		I.D.	Dimension		
	in	mm		dash size	T	E
0850N06-06	3/8	9.5	06	9/16-18	15	29
0850N06-08	3/8	9.5	06	3/4-16	19	32
0850N08-08	1/2	12.7	08	3/4-16	19	32
0850N08-10	1/2	12.7	08	7/8-14	24	36
0850N08-12	1/2	12.7	08	1.1/16-12	27	38
0850N10-10	5/8	15.9	10	7/8-14	24	37
0850N12-12	3/4	19	12	1.1/16-12	27	40
0850N16-16	1	25.4	16	1.5/16-12	34	45
0850N20-20	1.1/4	31.8	20	1.5/8-12	42	50
0850N24-24	1.1/2	38.1	24	1.7/8-12	55	52

JIC Female 74° Cone- Double Hexagon

(DKJ)

0900N 0901N

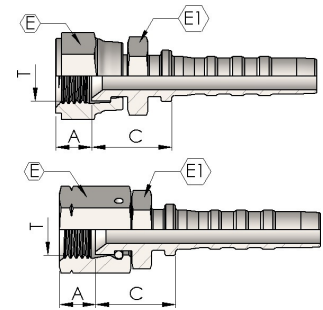

Product number	hose I.D.		Dimension					
	in	mm	dash size	T	E	E1	C	A
0901N06-06	3/8	9.5	06	9/16-18	19	17	26	9
0901N06-08	3/8	9.5	06	3/4-16	24	19	28	10.5
0901N08-08	1/2	12.7	08	3/4-16	24	22	28	10.5
0901N08-10	1/2	12.7	08	7/8-14	27	22	28	13
0900N08-12	1/2	12.7	08	1.1/16-12	32	27	33	13.5
0901N10-10	5/8	15.9	10	7/8-14	27	22	28	13
0900N12-12	3/4	19	12	1.1/16-12	32	27	34	13.5
0900N16-16	1	25.4	16	1.5/16-12	38	36	35	15.5
0900N20-20	1.1/4	31.8	20	1.5/8-12	50	46	42	16.5
0900N24-24	1.1/2	38.1	24	1.7/8-12	55	50	46	19

0950N 0951N

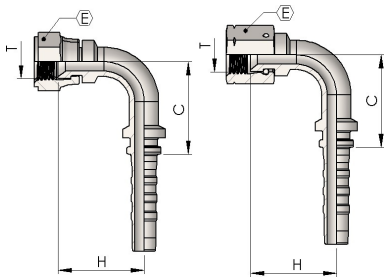

JIC 90° Swept Elbow 74° cone

Product number	hose I.D.		Dimension				
	in	mm	dash size	T	E	H	C
0951N06-06	3/8	9.5	06	9/16-18	19	32	31
0951N06-08	3/8	9.5	06	3/4-16	24	34	35
0951N08-08	1/2	12.7	08	3/4-16	24	41	41
0951N08-10	1/2	12.7	08	7/8-14	27	40	41
0950N08-12	1/2	12.7	08	1.1/16-12	32	43	39
0950N10-10	5/8	15.9	10	7/8-14	27	45	42
0950N12-12	3/4	19	12	1.1/16-12	32	54	56
0950N16-16	1	25.4	16	1.5/16-12	41	65	70
0950N20-20	1.1/4	31.8	20	1.5/8-12	50	85	82
0950N24-24	1.1/2	38.1	24	1.7/8-12	55	97	104

095SN

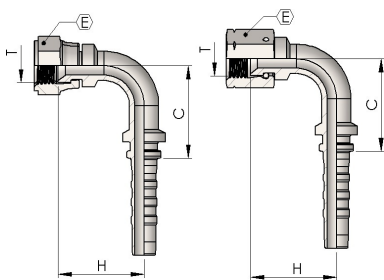

JIC 90° Swept Elbow 74° cone - ISO SHORT

Product number	hose I.D.		Dimension				
	in	mm	dash size	T	E	H	C
095SN06-06	3/8	9.5	06	9/16-18	19	23	31
095SN08-08	1/2	12.7	08	3/4-16	24	29	41
095SN10-10	5/8	15.9	10	7/8-14	27	32	42
095SN12-12*	3/4	19	12	1.1/16-12	32	48	56

*Thrust Wire Nut

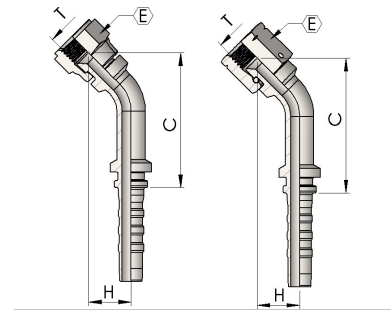
1000N 1001N**JIC 45° Swept Elbow 74°****(DKJ-45°)**

Product number	hose I.D.		Dimension				
	in	mm	dash size	T	E	H	C
1001N06-06	3/8	9.5	06	9/16-18	19	17	51
1001N06-08	3/8	9.5	06	3/4-16	24	19	51
1001N08-08	1/2	12.7	08	3/4-16	24	22	62
1001N08-10	1/2	12.7	08	7/8-14	27	23	64
1000N08-12	1/2	12.7	08	1.1/16-12	32	25	68
1001N10-10	5/8	15.9	10	7/8-14	27	24	68
1000N12-12	3/4	19	12	1.1/16-12	32	28	84
1000N16-16	1	25.4	16	1.5/16-12	41	32	83
1000N20-20	1.1/4	31.8	20	1.5/8-12	50	42	108
1000N24-24	1.1/2	38.1	24	1.7/8-12	55	49	156

S350N

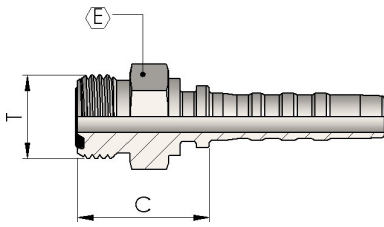

ORFS Male

(ORFS)

Product number	hose I.D.		Dimension			
	in	mm	dash size	T	E	Cut-off C
S350N06-09	3/8	9.5	06	11/16-16	19	26
S350N06-11	3/8	9.5	6	13/16-16	22	29
S350N08-11	1/2	12.7	08	13/16-16	22	29
S350N10-13	5/8	15.9	10	1-14	27	33
S350N12-14	3/4	19	12	1.3/16-12	32	36
S350N16-15	1	25.4	16	1.7/16-12	38	37
S350N16-21	1	25.4	16	1.11/16-12	46	38
S350N20-21	1.1/4	31.8	20	1.11/16-12	46	39
S350N20-32	1.1/4	31.8	20	2-12	55	48.5
S350N24-32	1.1/2	38.1	24	2-12	55	52.5

- with plug and O-Ring

S05TN

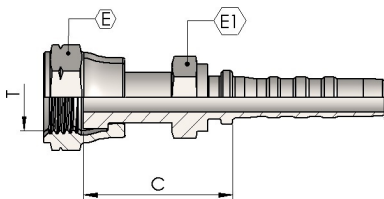

ORFS Female Back Hexagon

(ORFS)

Product number	hose I.D.		Dimension				I.D. Cut-off C
	in	dash size	mm	T	E	E1	
S05TN06-09	3/8	06	9.5	11/16-16	22	17	36
S05TN06-11	3/8	06	9.5	13/16-16	24	19	38
S05TN08-11	1/2	08	12.7	13/16-16	24	19	38
S05TN10-13	5/8	10	15.9	1-14	30	24	43
S05TN12-14	3/4	12	19	1.3/16-12	36	30	44
S05TN16-15	1	16	25.4	1.7/16-12	41	36	52
S05TN20-21	1.1/4	20	31.8	1.11/16-12	50	46	56
S05TN24-32	1.1/2	24	38.1	2-21	60	50	62

S150N

ORFS 90° Swept Elbow

(ORFS-90°)

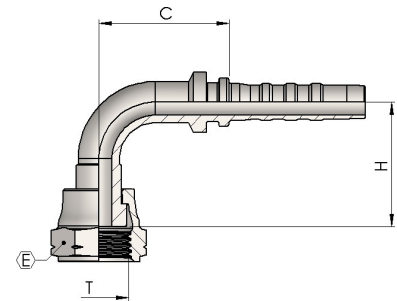

Product number	hose I.D.		Dimension				I.D.
	in	dash size	mm	T	E	H	Cut-off C
S150N06-09	3/8	06	9.5	11/16-16	22	33	33
S150N06-11	3/8	06	9.5	13/16-16	24	32	33
S150N08-11	1/2	08	12.7	13/16-16	24	36	43
S150N10-13	5/8	10	15.9	1-14	30	42	46
S150N12-14	3/4	12	19	1.3/16-12	36	49	57
S150N16-15	1	16	25.4	1.7/16-12	41	62	67
S150N16-21	1	20	25.4	1.11/16-12	50	58	62
S150N20-21	1.1/4	20	31.8	1.11/16-12	50	58	63
S150N20-32	1.1/4	20	31.8	2-12	60	73	63
S150N24-32	1.1/2	24	38.1	2-12	60	73	80

S155N

ORFS 90° Swept Elbow - ISO SHORT

(ORFS-90°)

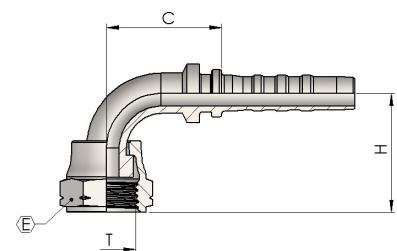

Product number	hose I.D.		Dimension				I.D.
	in	dash size	mm	T	E	H	Cut-off C
S155N04-06	1/4	04	6.4	9/16-18	19	21	25
S155N06-09	3/8	06	9.5	11/16-16	22	23	35
S155N08-11	1/2	08	12.7	13/16-16	24	29	44
S155N10-13	5/8	10	15.9	1-14	30	32	48
S155N12-14	3/4	12	19	1.3/16-12	36	48	58

S250N

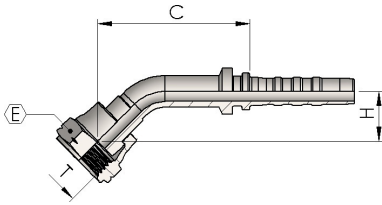

ORFS 45° Swept Elbow

(ORFS-45°)

Product number	hose I.D.		dash size	Dimension			
	in	mm		T	E	H	Cut-off C
S250N06-09	3/8	9.5	06	11/16-16	22	17	52
S250N06-11	3/8	9.5	06	13/16-16	24	18	51
S250N08-11	1/2	12.7	08	13/16-16	24	20	62
S250N10-13	5/8	15.9	10	1-14	30	22	67
S250N12-14	3/4	19	12	1.3/16-12	36	23	84
S250N16-15	1	25.4	16	1.7/16-12	41	27	101
S250N20-21	1.1/4	31.8	20	1.11/16-12	50	44	125
S250N20-32	1.1/4	31.8	20	2-12	60	44	125
S250N24-32	1.1/2	38.1	24	2-12	60	44	127

1250N

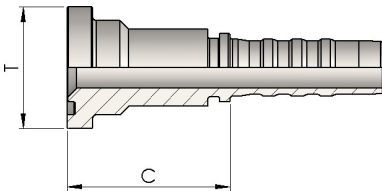

Straight SAE Flange 3000 PSI

(SFL)

Product number	hose I.D.		dash size	Dimension		
	in	mm		T Flange	mm	Cut-off C
1250N08-08	1/2	12.7	08	1/2	30,2	48
1250N12-12	3/4	19	12	3/4	38.1	54
1250N12-16	3/4	19	12	1	44.5	55
1250N16-16	1	25.4	16	1	44.5	56
1250N16-20	1	25.4	16	1.1/4	50.8	59
1250N20-20	1.1/4	31.8	20	1.1/4	50.8	62
1250N20-24	1.1/4	31.8	20	1.1/2	60.3	65
1250N24-24	1.1/2	38.1	24	1.1/2	60.3	67
1250N24-32	1.1/2	38.1	24	2	71.4	72

1050N

90° SAE Flange 3000 PSI

(SFL 90°)

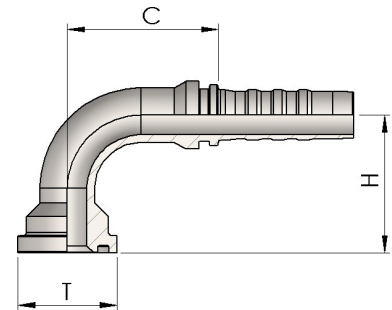

Product number	hose I.D.		Dimension				
	in	dash size	mm	T Flange	mm	drop H	Cut-off C
1050N08-08	1/2	08	12.7	1/2	30.2	39	40
1050N12-12	3/4	12	19	3/4	38.1	53	58
1050N12-16	3/4	12	19	1	44.5	58	58
1050N16-16	1	16	25.4	1	44.5	65	72
1050N16-20	1	16	25.4	1.1/4	50.8	70	72
1050N20-20	1.1/4	20	31.8	1.1/4	50.8	82	96.5
1050N20-24	1.1/4	20	31.8	1.1/2	60.3	85	96
1050N24-24	1.1/2	24	38.1	1.1/2	60.3	94	117

1150N

45° SAE Flange 3000 PSI

(SFL 45°)

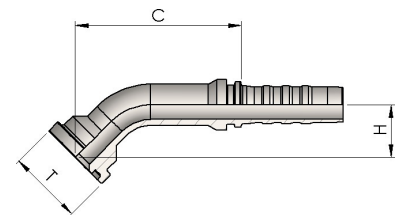

Product number	hose I.D.		Dimension				
	in	mm	dash size	T Flange	mm	drop H	Cut-off C
1150N12-12	3/4	19	12	3/4	38.1	25	81
1150N12-16	3/4	19	12	1	44.5	28	86
1150N16-16	1	25.4	16	1	44.5	32	79
1150N16-20	1	25.4	16	1.1/4	50.8	37	113
1150N20-20	1.1/4	31.8	20	1.1/4	50.8	39	103
1150N20-24	1.1/4	31.8	20	1.1/2	60.3	39	107
1150N24-24	1.1/2	38.1	24	1.1/2	60.3	44	159

1300N

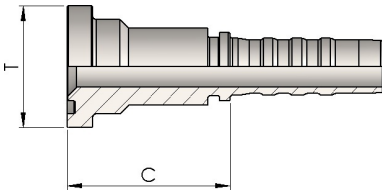

Straight SAE Flange 6000 PSI

(SFS)

Product number	hose I.D.		Dimension			
	in	mm	dash size	T Flange	mm	Cut-off C
1300N08-08	1/2	12.7	08	1/2	31,8	47
1300N12-12	3/4	19	12	3/4	41.3	56
1300N12-16	3/4	19	12	1	47.6	62
1300N16-16	1	25.4	16	1	47.6	63
1300N16-20	1	25.4	16	1.1/4	54	71
1300N20-20	1.1/4	31.8	20	1.1/4	54	73
1300N20-24	1.1/4	31.8	20	1.1/2	63.5	79
1300N24-24	1.1/2	38.1	24	1.1/2	63.5	81
1300N24-32	1.1/2	38.1	24	2	79.4	90

1100N

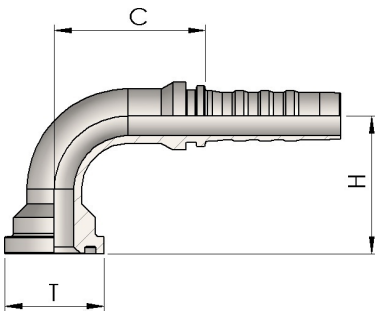

90° SAE Flange 6000 PSI

(SFS 90°)

Product number	hose I.D.		Dimension				
	in	mm	dash size	T Flange	mm	drop H	Cut-off C
1100N08-08	1/2	12.7	08	1/2	31,8	39	42
1100N10-12	5/8	15.9	10	3/4	41.3	51	46
1100N12-12	3/4	19	12	3/4	41.3	57	58
1100N12-16	3/4	19	12	1	47.6	63	56
1100N16-16	1	25.4	16	1	47.6	69	72
1100N16-20	1	25.4	16	1.1/4	54	77	72
1100N20-20	1.1/4	31.8	20	1.1/4	54	84.5	100
1100N20-24	1.1/4	31.8	20	1.1/2	63.5	92	101
1100N24-24	1.1/2	38.1	24	1.1/2	63.5	101	121.5

1200N

45° SAE Flange 6000 PSI

(SFS 45°)

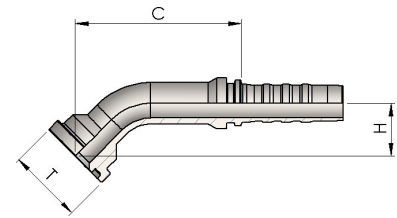

Product number	hose I.D.		Dimension				
	in	mm	dash size	T Flange	mm	drop H	Cut-off C
1200N08-08	1/2	12.7	08	1/2	31.8	22	62
1200N12-12	3/4	19	12	3/4	41.3	28	74
1200N12-16	3/4	19	12	1	47.6	32	90
1200N16-16	1	25.4	16	1	47.6	34	86
1200N16-20	1	25.4	16	1.1/4	54	39	90
1200N20-16	1.1/4	31.8	20	1	47.6	51	100
1200N20-20	1.1/4	31.8	20	1.1/4	54	41	111
1200N20-24	1.1/4	31.8	20	1.1/2	63.5	48	118
1200N24-20	1.1/2	38.1	24	1.1/4	54	40	154
1200N24-24	1.1/2	38.1	24	1.1/2	63.5	50	122
1200N24-32	1.1/2	38.1	24	2	79.4	59	128

130SN

Straight 'CAT' Flange

(SFC)

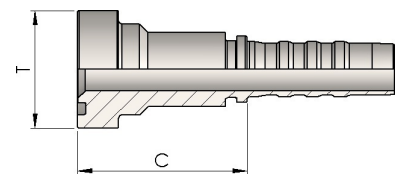

Product number	hose I.D.		I.D.	Dimension		
	in	mm		dash size	T Flange	mm
130SN12-12	3/4	19	12	3/4	41.3	60
130SN12-16	3/4	19	12	1	47.6	66
130SN16-16	1	25.4	16	1	47.6	67
130SN16-20	1	25.4	16	1.1/4	54	75
130SN20-20	1.1/4	31.8	20	1.1/4	54	77
130SN24-24	1.1/2	38.1	24	1.1/2	63.5	85

110SN

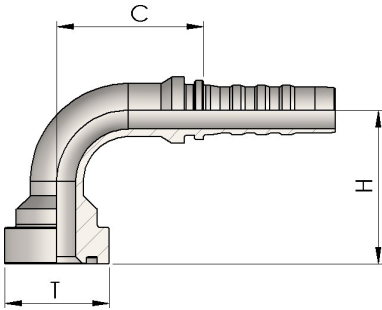

90° 'CAT' Flange

(SFC 90°)

Product number	hose I.D.		Dimension				
	in	mm	dash size	T Flange	mm	H	Cut-off C
110SN12-12	3/4	19	12	3/4	41.3	62	56
110SN12-16	3/4	19	12	1	47.6	65	56
110SN16-16	1	25.4	16	1	47.6	74	78
110SN16-20	1	25.4	16	1.1/4	54	80	78
110SN20-16	1.1/4	31.8	20	1	47.6	87	97
110SN20-20	1.1/4	31.8	20	1.1/4	54	90	97
110SN20-24	1.1/4	31.8	20	1.1/2	63.5	95	97
110SN24-20	1.1/2	38.1	24	1.1/4	54	101	115
110SN24-24	1.1/2	38.1	24	1.1/2	63.5	104	115
110SN24-32	1.1/2	38.1	24	2	79.4	114	115

120SN

45° 'CAT' Flange

(SFC 45°)

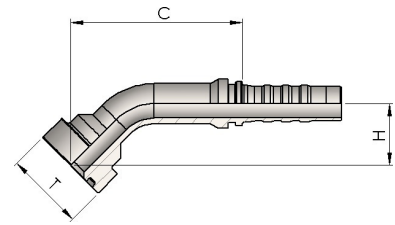

Product number	hose I.D.		Dimension				
	in	mm	dash size	T Flange	mm	H	Cut-off C
120SN12-12	3/4	19	12	3/4	41.3	32	88
120SN12-16	3/4	19	12	1	47.6	37	93
120SN16-16	1	25.4	16	1	47.6	37	90
120SN16-20	1	25.4	16	1.1/4	54	44	122
120SN20-16	1.1/4	31.8	20	1	47.6	40	111
120SN20-20	1.1/4	31.8	20	1.1/4	54	43	114
120SN20-24	1.1/4	31.8	20	1.1/2	63.5	48	119
120SN24-20	1.1/2	38.1	24	1.1/4	54	50	170
120SN24-24	1.1/2	38.1	24	1.1/2	63.5	52	172

Interlock Tail





004N



Swaged Ferrule (skive)

116

0042



Swaged Ferrule (skive)

116

0013



Swaged Ferrule (skive)

117

00J4



Swaged Ferrule (skive)

117

00J6



Swaged Ferrule (skive)

117



0370H



NPTF Male 60° cone

118



0350H



BSP Male Parallel 60° cone

118

0050H



BSP Female 60° cone Thrust Wire

119

0150H



BSP 90° Swept Elbow 60° cone Thrust Wire

119

0250H



BSP 45° Swept Elbow 60° Cone - Thrust Wire

120



0850H



JIC Male 74° cone

120



0900H



JIC Female 74° - Thrust Wire Nut

121

1000H



JIC 45° Swept Elbow 74° Cone - Thrust Wire

121



0450H



Metric Male 24° Seat Heavy

122

0084H



Metric Female 24° Seat Heavy

122



0184H



90° Metric Swept Elbow 24° Seat Heavy

123

0284H



45° Metric Swept Elbow 24° Seat Heavy

123



S350H



ORFS Male

124

S05TH



ORFS Female Back Hexagon

124

S150H



ORFS 90° Swept Elbow Hexagon

125

S250H



ORFS 45° Swept Elbow

125



1250H



Straight SAE Flange 3000 PSI

126

1050H



90° SAE Flange 3000 PSI

126

1150H



45° SAE Flange 3000 PSI

127

1300H



Straight SAE Flange
6000 PSI

128

1100H



90° SAE Flange 6000 PSI

129

1200H



45° SAE Flange 6000 PSI

130



130SH



Straight 'CAT' Flange

130

110SH



90° 'CAT' Flange

131

120SH



45° 'CAT' Flange

131



D050H



Hose Junction

132

004N

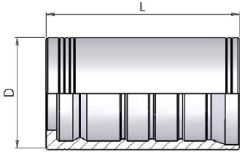

Swaged Ferrule (skive)

Product number	hose I.D.		Dimension		skive	valid for
	in	mm	D	L	Length	-
004N-12	3/4	19	38	60	52/15	R13-4SH-R15 -(4SP)
004N-16	1	25.4	46	75	64/17	4SH-R13-R15-(4SP)
004N-20	1.1/4	31.8	55	88	74/22	4SH
004N-24	1.1/2	38.1	62	94	81/22,5	4SH
004N-32	2	50.8	78	99	85/30	4SH

0042

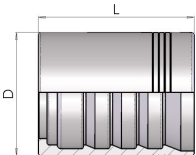

Swaged Ferrule (skive)

Product number	hose I.D.		Dimension		skive	valid for
	in	D	mm	L	Length	-
0042-20	1.1/4	60	31.8	88	74/22	IS42 - HyTraktion
0042-24	1.1/2	70	38.1	94	82/22	IS42 - HyTraktion

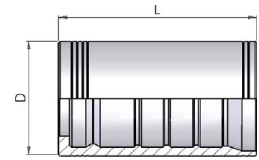
0013**Swaged Ferrule (skive)**

Product number	hose I.D.		Dimension		skive	valid for
	in	D	mm	L	Length	
0013-10	5/8	35.5	15.9	57.5	47/15	R15
0013-16	1	48	25.4	75	64/17	R13-R15
0013-20	1.1/4	60	31.8	88	74/22	R13 -R15
0013-24	1.1/2	67	38.1	94	81/22,5	R13 -R15
0013-32	2	85	50.8	99	85/30	R13-R15

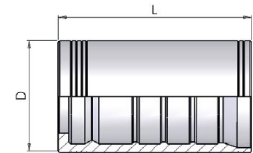
00J4**Swaged Ferrule (skive)**

Product number	hose I.D.		Dimension		skive	valid for
	in	mm	D	L	Length	
00J4-16	1	25.4	49	72.5	62/17	HySpir 500

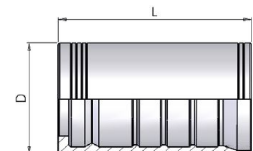
00J6**Swaged Ferrule (skive)**

Product number	hose I.D.		Dimension		skive	valid for
	in	mm	D	L	Length	
00J6-16	1	25.4	51	74.5	65/17	MegaJet

0370H

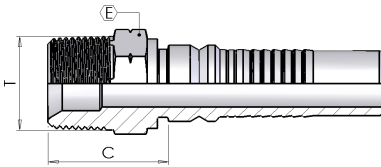

NPTF Male 60° cone

(AGN)

Product number	hose I.D.		Dimension			
	in	mm	dash size	Thread T	hex E	Cut-off C
0370H12-12	3/4	19	12	3/4-14	27	35
0370H16-16	1	25.4	16	1-11.1/2	36	41
0370H20-20	1.1/4	31.8	20	1.1/4-11.1/2	46	44
0370H24-24	1.1/2	38.1	24	1.1/2-11.1/2	50	47
0370H32-32	2	50.8	32	2-11.1/2	65	54

0350H

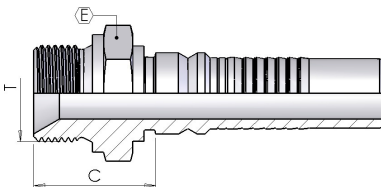

BSP Male Parallel 60° cone

(AGR)

Product number	hose I.D.		Dimension			
	in	mm	dash size	Thread T	hex E	Cut-off C
0350H12-12	3/4	19	12	3/4-14	32	33
0350H12-16	3/4	19	12	1-11	41	36
0350H16-16	1	25.4	16	1-11	41	37
0350H16-20	1	25.4	16	1.1/4-11	50	41
0350H20-20	1.1/4	31.8	20	1.1/4-11	50	42
0350H24-24	1.1/2	38.1	24	1.1/2-11	55	44
0350H32-32	2	50.8	32	2-11	70	53

0050H

BSP Female 60° cone Thrust Wire

(DKR)

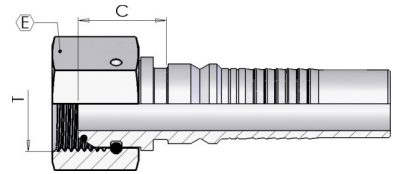

Product number	hose I.D.		Dimension			
	in	mm	dash size	Thread T	hex E	Cut-off C
0050H12-12	3/4	19	12	3/4-14	32	23
0050H12-16	3/4	19	12	1-11	41	25
0050H16-16	1	25.4	16	1-11	41	26
0050H20-20	1.1/4	31.8	20	1.1/4-11	50	29
0050H20-24	1.1/4	31.8	20	1.1/2-11	55	31
0050H24-24	1.1/2	38.1	24	1.1/2-11	55	31
0050H32-32	2	50.8	32	2-11	70	30

0150H

BSP 90° Swept Elbow 60° cone Thrust Wire

(DKR 90°)

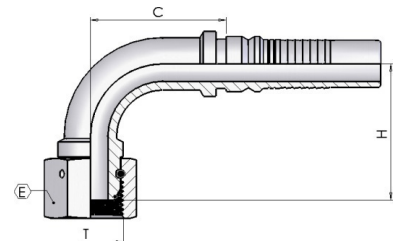

Product number	hose I.D.		Dimension				
	in	dash size	mm	Thread T	hex E	drop H	Cut-off C
0150H12-12	3/4	12	19	3/4-14	32	60	51
0150H16-16	1	16	25.4	1-11	41	70	73
0150H16-20	1	16	25.4	1.1/4-11	50	76	73
0150H20-20	1.1/4	20	31.8	1.1/4-11	50	83	93
0150H24-24	1.1/2	24	38.1	1.1/2-11	55	104	111

0250H

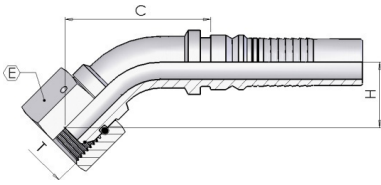

BSP 45° Swept Elbow 60° Cone - Thrust Wire

(DKR 45°)

Product number	hose I.D.		Dimension				
	in	dash size	mm	Thread T	hex E	drop H	Cut-off C
0250H12-12	3/4	12	19	3/4-14	32	31	85
0250H16-16	1	16	25.4	1-11	41	38	112
0250H20-20	1.1/4	20	31.8	1.1/4-11	50	41	98
0250H24-24	1.1/2	24	38.1	1.1/2-11	55	54	166
0250H32-32	2	32	50.8	2-11	70	71	143

0850H

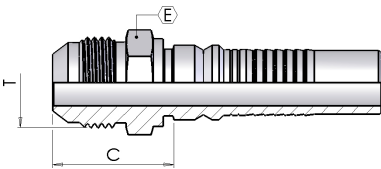

JIC Male 74° cone

(AGJ)

Product number	hose I.D.		Dimension			
	in	mm	dash size	Thread T	hex E	Cut-off C
0850H12-12	3/4	19	12	1.1/16-12	27	36
0850H16-16	1	25.4	16	1.5/16-12	34	40
0850H20-20	1.1/4	31.8	20	1.5/8-12	42	44
0850H24-24	1.1/2	38.1	24	1.7/8-12	50	49

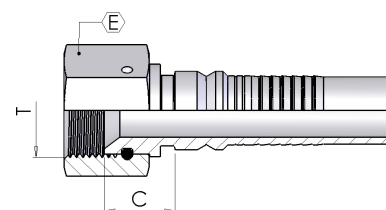
0900H**JIC Female 74° - Thrust Wire Nut****(DKJ)**

Product number	hose I.D.		Dimension			
	in	mm	dash size	Thread T	hex E	Cut-off C
0900H12-12	3/4	19	12	1.1/16-12	32	19
0900H12-16	3/4	19	12	1.5/16-12	41	22
0900H16-16	1	25.4	16	1.5/16-12	41	23
0900H20-20	1.1/4	31.8	20	1.5/8-12	50	26
0900H24-24	1.1/2	38.1	24	1.7/8-12	55	29
0900H32-32	2	50.8	32	2.1/2-12	70	30

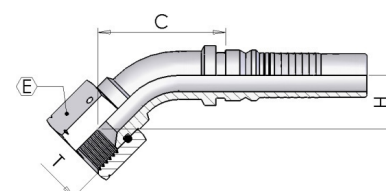
1000H**JIC 45° Swept Elbow 74° Cone - Thrust Wire****(DKJ 45°)**

Product number	hose I.D.		Dimension				
	in	dash size	mm	Thread T	hex E	drop H	Cut-off C
1000H12-12	3/4	12	19	1.1/16-12	32	28	85
1000H12-16	3/4	12	19	1.5/16-12	41	32	88
1000H16-16	1	16	25.4	1.5/16-12	41	33	83
1000H20-20	1.1/4	20	31.8	1.5/8-12	50	40	109
1000H24-24	1.1/2	24	38.1	1.7/8-12	55	49	165

0450H

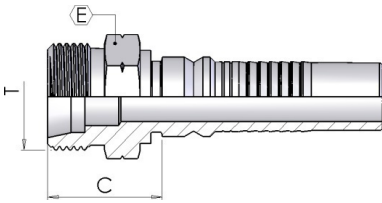

Metric Male 24° Seat Heavy

(CES)

Product number	hose I.D.		Dimension				
	in	mm	dash size	Thread T	erm.	hex E	Cut-off C
0450H12-36	3/4	19	12	M36-2	25	36	36
0450H16-42	1	25.4	16	M42-2	30	46	39
0450H20-52	1.1/4	31.8	20	M52-2	38	55	42
0450H24-52	1.1/2	38.1	24	M52-2	38	55	42.5

0084H

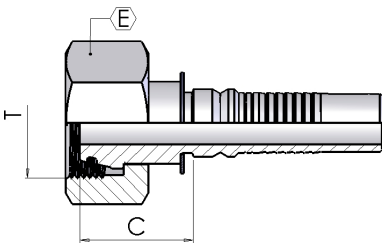

Metric Female 24° Seat Heavy

(DKOS)

Product number	hose I.D.		Dimension				
	in	mm	dash size	Thread T	erm.	hex E	Cut-off C
0084H12-36	3/4	19	12	M36-2	25	46	37
0084H16-36	1	25.4	16	M36-2	25	46	38
0084H16-42	1	25.4	16	M42-2	30	50	41
0084H20-42	1.1/4	31.8	20	M42-2	30	50	32
0084H20-52	1.1/4	31.8	20	M52-2	38	60	41
0084H24-52	1.1/2	38.1	24	M52-2	38	60	42

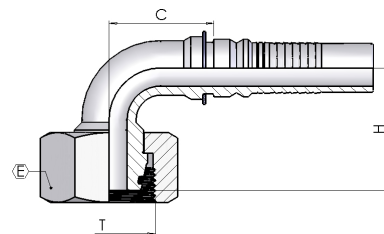
0184H**90° Metric Swept Elbow 24° Seat
Heavy****(DKOS 90°)**

Product number	hose I.D.		Dimension					
	in	dash size	mm	Thread T	erm.	hex E	drop H	Cut-off C
0184H12-36	3/4	12	19	M36-2	25	46	58	55
0184H16-36	1	16	25.4	M36-2	25	46	68	75
0184H16-42	1	16	25.4	M42-2	30	50	69	74
0184H20-52	1.1/4	20	31.8	M52-2	38	60	83	94

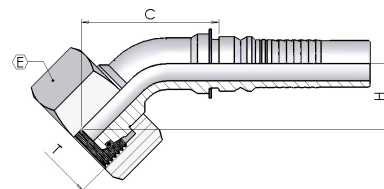
0284H**45° Metric Swept Elbow 24° Seat
Heavy****(DKOS 45°)**

Product number	hose I.D.		Dimension					
	in	dash size	mm	Thread T	erm.	hex E	drop H	Cut-off C
0284H12-36	3/4	12	19	M36-2	25	46	31	86
0284H16-36	1	16	25.4	M36-2	25	46	34	82
0284H16-42	1	16	25.4	M42-2	30	50	33	84
0284H20-52	1.1/4	20	31.8	M52-2	38	60	40	105

S350H

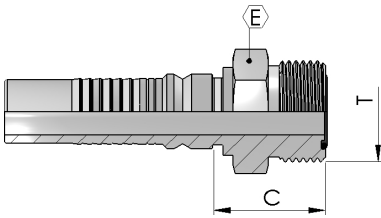

ORFS Male

(ORFS)

Product number	hose I.D.		Dimension			
	in	mm	dash size	Thread T	hex E	Cut-off C
S350H12-14-BO	3/4	19	12	1.3/16-12	32	34
S350H16-15-BO	1	25.4	16	1.7/16-12	38	35
S350H20-21-BO	1.1/4	31.8	20	1.11/16-12	46	36
S350H24-32-BO	1.1/2	38.1	24	2-12	55	38

S05TH

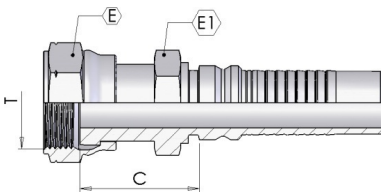

ORFS Female Back Hexagon

(ORFS)

Product number	hose I.D.		Dimension				
	in	mm	dash size	Thread T	hex E	E1	Cut-off C
S05TH12-14	3/4	19	12	1.3/16-12	36	30	39
S05TH16-15	1	25.4	16	1.7/16-12	41	36	47
S05TH20-21	1.1/4	31.8	20	1.11/16-12	50	46	50

S150H

ORFS 90° Swept Elbow

(ORFS 90°)

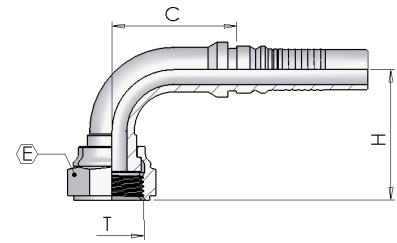

Product number	hose I.D.		Dimension				
	in	mm	dash size	Thread T	hex E	drop H	Cut-off C
S150H12-14	3/4	19	12	1.3/16-12	36	54	50
S150H16-15	1	25.4	16	1.7/16-12	41	66	69
S150H20-21	1.1/4	31.8	20	1.11/16-12	50	80	87

S250H

ORFS 45° Swept Elbow

(ORFS 45°)

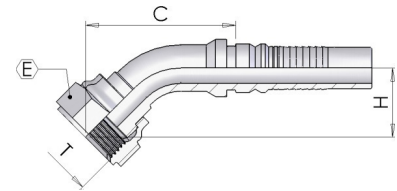

Product number	hose I.D.		Dimension				
	in	mm	dash size	Thread T	hex E	drop H	Cut-off C
S250H12-14	3/4	19	12	1.3/16-12	36	23	84
S250H16-15	1	25.4	16	1.7/16-12	41	28	77
S250H20-21	1.1/4	31.8	20	1.11/16-12	50	37	130

1250H

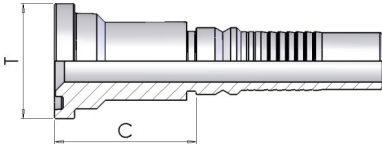

Straight SAE Flange 3000 PSI

(SFL)

Product number	hose I.D.		Dimension			
	in	mm	dash size	T Flange	mm	Cut-off C
1250H12-12	3/4	19	12	3/4	38.1	47
1250H12-16	3/4	19	12	1	44.5	50
1250H16-16	1	25.4	16	1	44.5	52
1250H20-20	1.1/4	31.8	20	1.1/4	50.8	56
1250H20-24	1.1/4	31.8	20	1.1/2	60.3	59
1250H24-24	1.1/2	38.1	24	1.1/2	60.3	60
1250H32-32	2	50.8	32	2	71.4	67

1050H

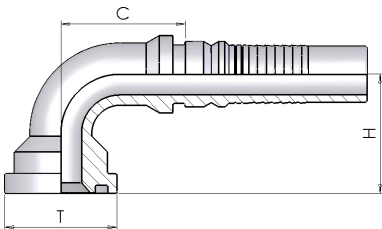

90° SAE Flange 3000 PSI

(SFL 90°)

Product number	hose I.D.		Dimension				
	in	dash size	mm	T Flange	mm	drop H	Cut-off C
1050H12-12	3/4	12	19	3/4	38.1	52	52
1050H12-16	3/4	12	19	1	44.5	56	55
1050H16-16	1	16	25.4	1	44.5	65	73
1050H20-20	1.1/4	20	31.8	1.1/4	50.8	82	91
1050H24-24	1.1/2	24	38.1	1.1/2	60.3	94	109
1050H32-32	2	32	50.8	2	71.4	113	128

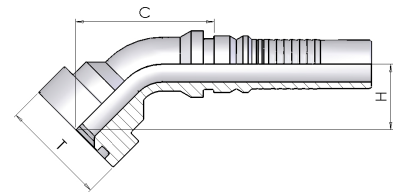
1150H**45° SAE Flange 3000 PSI****(SFL 45°)**

Product number	hose I.D.		Dimension				
	in	mm	dash size	T Flange	mm	drop H	Cut-off C
1150H12-12	3/4	19	12	3/4	38.1	25	81
1150H12-16	3/4	19	12	1	44.5	28	86
1150H16-16	1	25.4	16	1	44.5	35	107
1150H16-20	1	25.4	16	1.1/4	50.8	37	113
1150H20-20	1.1/4	31.8	20	1.1/4	50.8	37	113
1150H20-24	1.1/4	31.8	20	1.1/2	60.3	40	113
1150H24-24	1.1/2	38.1	24	1.1/2	60.3	44	125
1150H24-32	1.1/2	38.1	24	2	71.4	40	126
1150H32-32	2	50.8	32	2	71.4	50	133

1300H

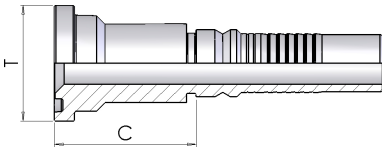

Straight SAE Flange 6000 PSI

(SFS)

Product number	hose I.D.		Dimension			
	in	mm	dash size	T Flange	mm	Cut-off C
1300H12-12	3/4	19	12	3/4	41.3	51
1300H12-16	3/4	19	12	1	47.6	57
1300H16-12	1	25.4	16	3/4	41.3	52
1300H16-16	1	25.4	16	1	47.6	59
1300H16-20	1	25.4	16	1.1/4	54	66
1300H20-16	1.1/4	31.8	20	1	47.6	60
1300H20-20	1.1/4	31.8	20	1.1/4	54	67
1300H20-24	1.1/4	31.8	20	1.1/2	63.5	73
1300H24-20	1.1/2	38.1	24	1.1/4	54	75
1300H24-24	1.1/2	38.1	24	1.1/2	63.5	74
1300H24-32	1.1/2	38.1	24	2	79.4	82
1300H32-32	2	50.8	32	2	79.4	84

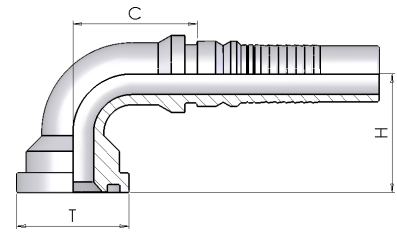
1100H**90° SAE Flange 6000 PSI****(SFS 90°)**

Product number	hose I.D.		Dimension				
	in	mm	dash size	T Flange	mm	drop H	Cut-off C
1100H12-12	3/4	19	12	3/4	41.3	55	53
1100H12-16	3/4	19	12	1	47.6	63	52
1100H16-12	1	25.4	16	3/4	41.3	66	73
1100H16-16	1	25.4	16	1	47.6	69	75
1100H16-20	1	25.4	16	1.1/4	54	74	71
1100H20-16	1.1/4	31.8	20	1	47.6	80	93
1100H20-20	1.1/4	31.8	20	1.1/4	54	84,5	93
1100H20-24	1.1/4	31.8	20	1.1/2	63.5	92	94
1100H24-24	1.1/2	38.1	24	1.1/2	63.5	101	114
1100H24-32	1.1/2	38.1	24	2	79.4	115	115
1100H32-32	2	50.8	32	2	79.4	126	136.5

1200H

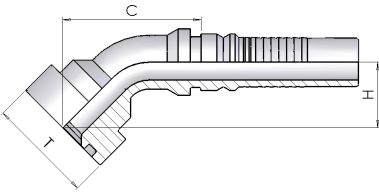

45° SAE Flange 6000 PSI

(SFS 45°)

Product number	hose I.D.		Dimension				
	in	mm	dash size	T Flange	mm	drop H	Cut-off C
1200H12-12	3/4	19	12	3/4	41.3	28	85
1200H12-16	3/4	19	12	1	47.6	34	88
1200H16-12	1	25.4	16	3/4	41.3	31	79
1200H16-16	1	25.4	16	1	47.6	34	85
1200H16-20	1	25.4	16	1.1/4	54	40	89
1200H20-16	1.1/4	31.8	20	1	47.6	34	93
1200H20-20	1.1/4	31.8	20	1.1/4	54	41	109
1200H24-24	1.1/2	38.1	24	1.1/2	63.5	50	133
1200H32-32	2	50.8	32	2	79.4	58	151

130SH

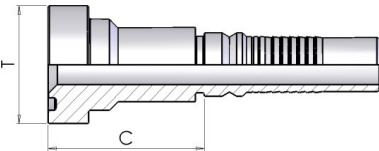

Straight 'CAT' Flange

(SFC)

Product number	hose I.D.		Dimension			
	in	mm	dash size	T Flange	mm	Cut-off C
130SH12-12	3/4	19	12	3/4	41.3	55
130SH12-16	3/4	19	12	1	47.6	62
130SH16-16	1	25.4	16	1	47.6	63
130SH16-20	1	25.4	16	1.1/4	54	70
130SH20-20	1.1/4	31.8	20	1.1/4	54	71
130SH24-24	1.1/2	38.1	24	1.1/2	64	78

110SH

90° 'CAT' Flange

(SFC 90°)

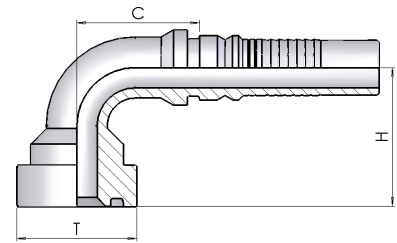

Product number	hose I.D.		Dimension				
	in	mm	dash size	T Flange	mm	drop H	Cut-off C
110SH12-12	3/4	19	12	3/4	41.3	62	51
110SH16-16	1	25.4	16	1	47.6	75	73.2
110SH16-20	1	25.4	16	1.1/4	54	82	74
110SH20-20	1.1/4	31.8	20	1.1/4	54	89	93
110SH24-24	1.1/2	38.1	24	1.1/2	63.5	106	110

120SH

45° 'CAT' Flange

(SFC 45°)

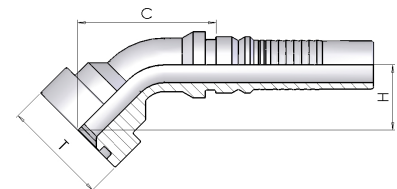

Product number	hose I.D.		Dimension				
	in	mm	dash size	T Flange	mm	drop H	Cut-off C
120SH12-12	3/4	19	12	3/4	41.3	30	89
120SH16-16	1	25.4	16	1	47.6	38	115
120SH24-24	1.1/2	38.1	24	1.1/2	63.5	52	169

D050H

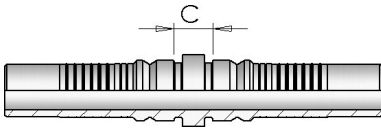

Hose Junction

Product number	hose I.D.		I.D.		Dimension	
	in	mm	dash size	Cut-off C		
D050H12	3/4	19	12	15		
D050H16	1	25.4	16	16		
D050H20	1.1/4	31.8	20	19		
D050H24	1.1/2	38.1	24	19		
D050H32	2	50.8	32	24		

Hyblast / Multispiral Tail





00Y4



Swaged Ferrule (skive)

136

00Y6



Swaged Ferrule (skive)

136

0019



Swaged Ferrule (skive)

136

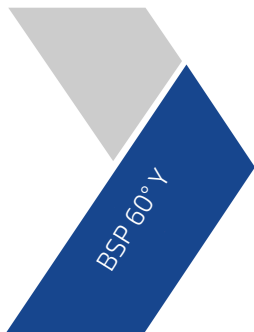

0050Y



BSP Female 60° cone
Thrust Wire

137



0370Y



NPTF Male 60° cone

137



0084Y



Metric Female 24° Seat
Heavy

138



002M

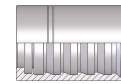

Swaged Ferrule (skive)

138



0900M



JIC Female 74° - Thrust
Wire Nut

139

0950M



JIC 90° Swept Elbow 74°
Cone - Thrust Wire

139



0050M



BSP Female 60° cone Thrust Wire

139

0150M



BSP 90° Swept Elbow 60° cone Thrust Wire

140



0370M



NPTF Male 60° cone

140



0084M



Metric Female 24° Seat Heavy

140

0184M



90° Metric Swept Elbow 24° Seat Heavy

141

00Y4

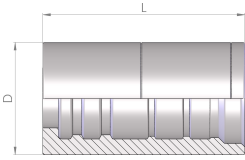

Swaged Ferrule (skive)

Product number	hose I.D.	I.D.	Dimension		valid for
	in	mm	D	L	
00Y4-06	3/8	9.5	32.5	58.5	HB18k
00Y4-08	1/2	12.7	36.5	62	HB18k
00Y4-12	3/4	19	43.8	69	HB15k

00Y6

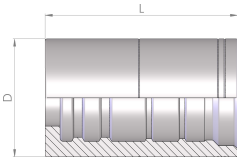

Swaged Ferrule (skive)

Product number	hose I.D.	I.D.	Dimension	
	in	mm	D	L
00Y6-06	3/8	9.5	35.5	58.5
00Y6-08	1/2	12.7	39.8	62
00Y6-12	3/4	19	47	69

0019

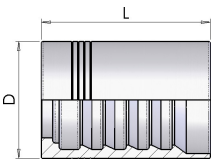

Swaged Ferrule (skive)

Product number	hose I.D.	Dimension		skive	valid for	
	in	D	mm	L		Length
0019-04	1/4	21	6.4	40	30	WB-VHP-4SP-4SH

0050Y

BSP Female 60° cone Thrust Wire

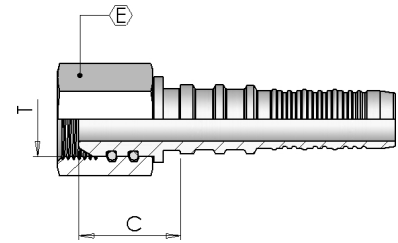

Product number	hose I.D.		Dimension			
	in	mm	dash size	Thread T	hex E	Cut-off C
0050Y08-08	1/2	12.7	08	1/2-14	30	33
0050Y16-16	1	25.4	16	1-11	38	40

0370Y

NPTF Male 60° cone

(AGN)

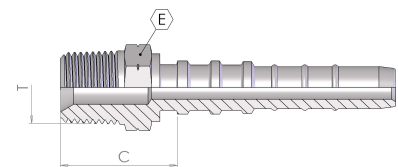

Product number	hose I.D.		I.D.	Dimension		
	in	mm		dash size	Cut-off C	T
0370Y06-06	3/8	9.5	06	29	3/8-18	19
0370Y08-08	1/2	12.7	08	35	1/2-14	22
0370Y12-12	3/4	19	12	37	3/4-14	27
0370Y16-16	1	25.4	16	49	1-11.1/2	38

0084Y

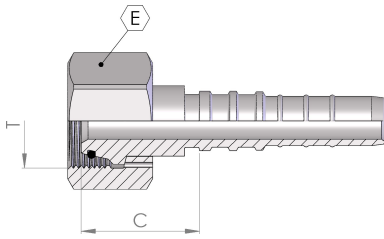

Metric Female 24° Seat Heavy

(DKOS)

Product number	hose I.D.		Dimension				
	in	mm	dash size	T	erm.	E	Cut-off C
0084Y06-22	3/8	9.5	06	M22-1.5	14	30	38
0084Y06-24	3/8	9.5	06	M24-1.5	16	32	39
0084Y08-24	1/2	12.7	08	M24-1.5	16	34	39
0084Y12-36	3/4	19	12	M36-2	25	46	45

002M

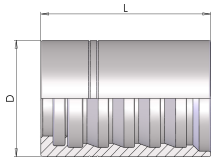

Swaged Ferrule (skive)

Product number	hose I.D.	Dimension		I.D.	skive
	in	D	mm	L	Length
002M-04	1/4	19.6	6.4	38	29
002M-06	3/8	24	9.5	40	31

0900M

JIC Female 74° - Thrust Wire Nut

(DKJ)

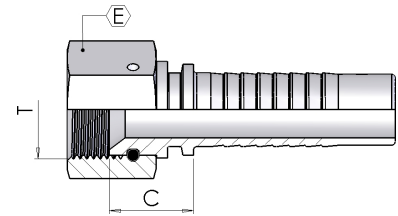

Product number	hose I.D.		Dimension			
	in	mm	dash size	Thread T	hex E	Cut-off C
0900M04-04	1/4	6.4	04	7/16-20	17	16
0900M06-06	3/8	9.5	06	9/16-18	19	18
0900M06-08	3/8	9.5	06	3/4-16	24	20

0950M

JIC 90° Swept Elbow 74° Cone - Thrust Wire

(DKJ 90°)

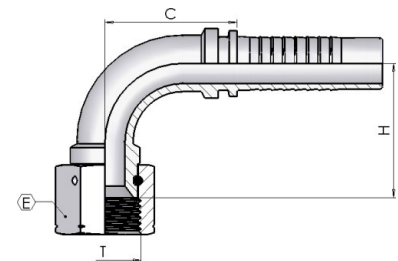

Product number	hose I.D.		Dimension				
	in	mm	dash size	Thread T	hex E	drop H	Cut-off C
0950M04-04	1/4	6.4	04	7/16-20	17	26	26
0950M06-06	3/8	9.5	06	9/16-18	19	33	35
0950M06-08	3/8	9.5	06	3/4-16	24	34	35

0050M

BSP Female 60° cone Thrust Wire

(DKR)

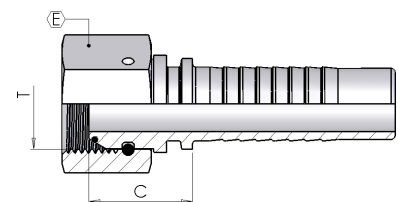

Product number	hose I.D.		Dimension			
	in	mm	dash size	Thread T	hex E	Cut-off C
0050M04-04	1/4	6.4	04	1/4-19	19	20

0150M

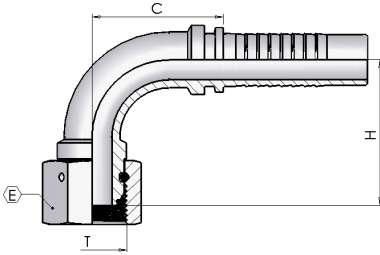

BSP 90° Swept Elbow 60° cone Thrust Wire

(DKR 90°)

Product number	hose I.D.		Dimension				
	in	mm	dash size	Thread T	hex E	drop H	Cut-off C
0150M04-04	1/4	6.4	04	1/4-19	19	28	26

0370M

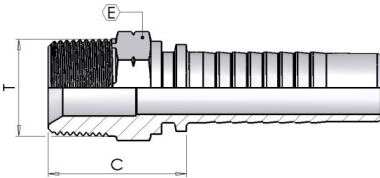

NPTF Male 60° cone

(AGN)

Product number	hose I.D.		Dimension			
	in	mm	dash size	Thread T	hex E	Cut-off C
0370M04-04	1/4	6.4	04	1/4-18	15	29
0370M06-06	3/8	9.5	06	3/8-18	19	29

0084M

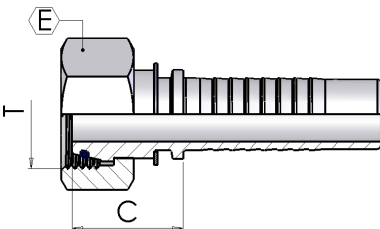

Metric Female 24° Seat Heavy

(DKOS)

Product number	hose I.D.		Dimension				
	in	mm	dash size	Thread T	erm.	hex E	Cut-off C
0084M04-16	1/4	6.4	04	M16-1.5	8	19	27
0084M04-18	1/4	6.5	04	M18-1.5	10	22	24

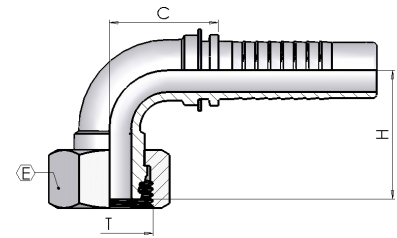
0184M**90° Metric Swept Elbow 24° Seat Heavy****(DKOS 90°)**

Product number	hose I.D.		Dimension					
	in	dash size	mm	Thread T	erm.	hex E	drop H	Cut-off C
0184M04-16	1/4	04	6.4	M16-1.5	8	19	26	28
0184M04-18	1/4	04	6.4	M18-1.5	10	22	31	33

Low Pressure Fittings





P050



BSP Female 60° cone - UniLock

144

P150



BSP 90° Swept elbow 60° cone - UniLock

144



BA



Steel ferrule

145

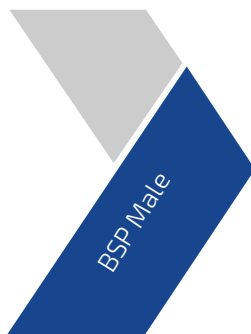

0345B



BSP Male - Flat Seat

146

0350B



BSP Male Parallel 60° cone

147

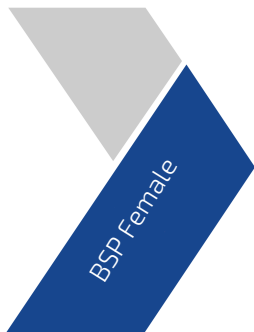

0051B



BSP Female 60° Cone

148

0151B



BSP 90° Swept Elbow 60° Cone

149

0251B



BSP 45° Swept Elbow 60° Cone

150

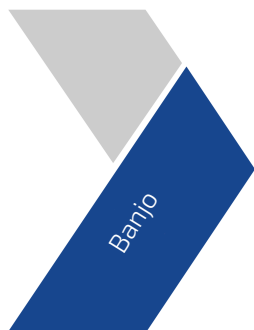

1350B



Metric Banjo

151

P050

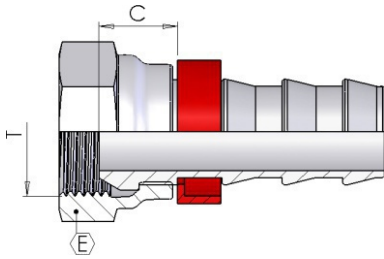

BSP Female 60° cone - UniLock

Product number	hose I.D.		Dimension			
	in	mm	dash size	Thread T	hex E	Cut-off C
P050-04-04	1/4	6.4	04	1/4-19	17	10
P050-06-06	3/8	9.5	06	3/8-19	19	10
P050-08-08	1/2	12.7	08	1/2-14	27	13
P050-12-12	3/4	19	12	3/4-14	32	16
P050-16-16	1	25.4	16	1-11	38	15

P150

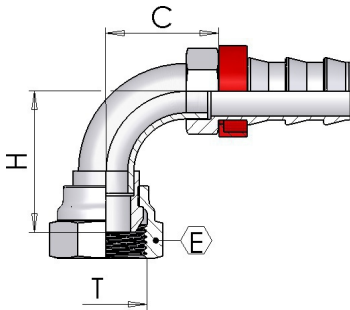

BSP 90° Swept elbow 60° cone - UniLock

Product number	hose I.D.		Dimension				
	in	mm	dash size	Thread T	hex E	drop H	Cut-off C
P150-04-04	1/4	6.4	04	1/4-19	17	23	21
P150-06-06	3/8	9.5	06	3/8-19	19	29	31
P150-08-08	1/2	12.7	08	1/2-14	27	36	38
P150-12-12	3/4	19	12	3/4-14	32	65	54
P150-16-16	1	25.4	16	1-11	38	55	44

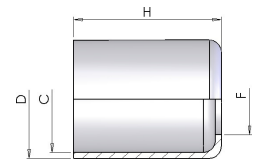
BA**Steel ferrule**

Product number	Dimension			
	D	C	F	H
BA-021-024	24	21	16	31
BA-024-027	27	24	18	31
BA-027-030	30	27	20	34
BA-029-032	32	29	21	35
BA-035-038	38	35	27	36
BA-037-040	40	37	28	38
BA-039-042	42	39	29	40
BA-046-050	50	46	34	46
BA-085-090	90	85	68	63
BA-095-100	100	95	78	68

0345B

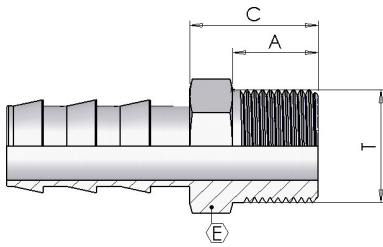

BSP Male - Flat Seat

Product number	hose I.D.		Dimensions		Dimension		
	in	mm	DN	Thread T	Cut-off C	A	hex E
0345B04-02	1/4	6.4	06	1/8	16	10	14
0345B04-04	1/4	6.4	06	1/4	16	10	14
0345B05-04	5/16	7.9	08	1/4	16	10	14
0345B05-06	5/16	7.9	08	3/8	19	12	17
0345B06-04	3/8	9.5	10	1/4	16	10	17
0345B06-06	3/8	9.5	10	3/8	19	12	17
0345B06-08	3/8	9.5	10	1/2	21	13	22
0345B08-06	1/2	12.7	13	3/8	19	12	19
0345B08-08	1/2	12.7	13	1/2	21	13	22
0345B10-06	5/8	15.9	16	3/8	19	12	19
0345B10-08	5/8	15.9	16	1/2	21	13	22
0345B10-12	5/8	15.9	16	3/4	21	15	27
0345B12-08	3/4	19	19	1/2	21	13	24
0345B12-12	3/4	19	19	3/4	23	15	27
0345B12-16	3/4	19	19	1	25	16	34
0345B16-12	1	25.4	25	3/4	23	15	30
0345B16-16	1	25.4	25	1	25	16	34
0345B20-12	1.1/4	31.8	32	3/4	23	15	34
0345B20-16	1.1/4	31.8	32	1	26	16	36
0345B20-20	1.1/4	31.8	32	1.1/4	27	17	42
0345B24-20	1.1/2	38.1	38	1.1/4	27	17	42
0345B24-24	1.1/2	38.1	38	1.1/2	29	18	50
0345B32-32	2	50.8	50	2	31	19	60
0345B40-40	2.1/2	63.5	70	2.1/2	36	23	75

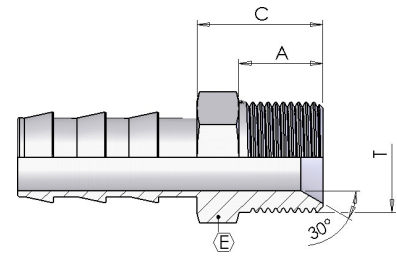
0350B**BSP Male Parallel 60° cone**

Product number	hose I.D.		Dimensions		Dimension		
	in	mm	DN	Thread T	Cut-off C	A	hex E
0350B04-02	1/4	6.4	06	1/8	14	9	14
0350B04-04	1/4	6.4	06	1/4	16	10	19
0350B05-04	5/16	7.9	08	1/4	16	10	19
0350B06-04	3/8	9.5	10	1/4	16	10	19
0350B06-06	3/8	9.5	10	3/8	18	12	22

0051B

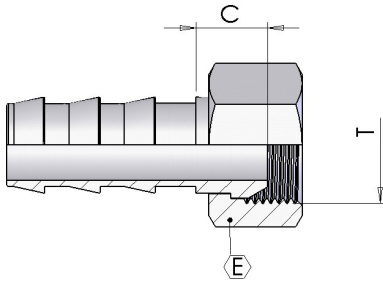

BSP Female 60° Cone

Product number	hose I.D.		Dimensions	Dimension		
	in	mm		DN	Thread T	Cut-off C
0051B03-02	3/16	4.8	05	1/8	9	14
0051B04-02	1/4	6.4	06	1/8	9	14
0051B04-04	1/4	6.4	06	1/4	10	17
0051B05-04	5/16	7.9	08	1/4	10	17
0051B05-06	5/16	7.9	08	3/8	11	19
0051B06-06	3/8	9.5	10	3/8	11	19
0051B06-08	3/8	9.5	10	1/2	12	24
0051B08-06	1/2	12.7	13	3/8	11	19
0051B08-08	1/2	12.7	13	1/2	12	24
0051B10-08	5/8	15.9	16	1/2	12	24
0051B10-12	5/8	15.9	16	3/4	14	30
0051B12-12	3/4	19	19	3/4	14	30
0051B12-16	3/4	19	19	1	15	38
0051B16-16	1	25.4	25	1	16	38
0051B20-20	1.1/4	31.8	32	1.1/4	16	46
0051B20-24	1.1/4	31.8	32	1.1/2	18	55
0051B24-24	1.1/2	38.1	38	1.1/2	18	55
0051B32-32	2	50.8	50	2	19	65
0051B40-40	2.1/2	63.5	60	2.1/2	24	85
0051B48-48	3	76.2	70	3	26	100

0151B

BSP 90° Swept Elbow 60° Cone

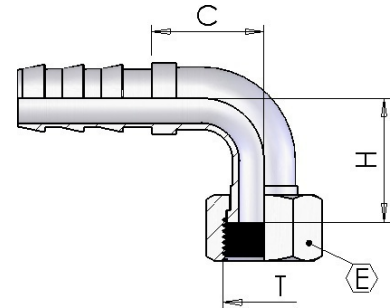

Product number	hose I.D.		Dimensions DN	Dimension			
	in	mm		Thread T	Cut-off C	drop H	hex E
0151B04-04	1/4	6.4	06	1/4	28	25	17
0151B05-04	5/16	7.9	08	1/4	28	25	17
0151B05-06	5/16	7.9	08	3/8	32	32	19
0151B06-06	3/8	9.5	10	3/8	33	33	19
0151B06-08	3/8	9.5	10	1/2	38	35	24
0151B08-06	1/2	12.7	13	3/8	38	35	19
0151B08-08	1/2	12.7	13	1/2	43	41	24
0151B08-12	1/2	12.7	13	3/4	40	45	30
0151B10-08	5/8	15.9	16	1/2	44	41	24
0151B10-12	5/8	15.9	16	3/4	40	45	30
0151B12-12	3/4	19	19	3/4	51	49	30
0151B12-16	3/4	19	19	1	45	49	38
0151B16-12	1	25.4	25	3/4	45	57	32
0151B16-16	1	25.4	25	1	60	58	38
0151B16-20	1	25.4	25	1.1/4	56	64	46
0151B20-20	1.1/4	31.8	32	1.1/4	70	66	46
0151B24-24	1.1/2	38.1	38	1.1/2	70	75	55
0151B32-32	2	50.8	50	2	66	70	65
0151B40-40	2.1/2	63.5	60	2.1/2	82	85	85

0251B

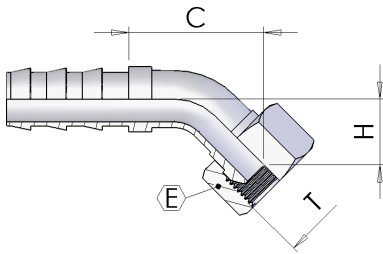

BSP 45° Swept Elbow 60° Cone

Product number	hose I.D.		Dimensions DN	Dimension			
	in	mm		Thread T	Cut-off C	drop H	hex E
0251B04-04	1/4	6.4	06	1/4	44	17	17
0251B05-06	5/16	7.9	08	3/8	50	19	19
0251B06-06	3/8	9.5	10	3/8	52	20	19
0251B06-08	3/8	9.5	10	1/2	54	23	24
0251B08-06	1/2	12.7	13	3/8	54	23	19
0251B08-08	1/2	12.7	13	1/2	60	25	24
0251B10-12	5/8	15.9	16	3/4	65	28	30
0251B12-12	3/4	19	19	3/4	65	28	30
0251B12-16	3/4	19	19	1	55	30	38
0251B16-16	1	25.4	25	1	74	30	38
0251B20-20	1.1/4	31.8	32	1.1/4	72	35	46
0251B24-24	1.1/2	38.1	38	1.1/2	72	35	55
0251B32-32	2	50.8	50	2	90	50	65

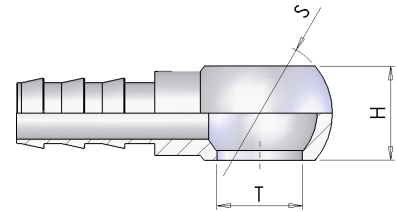
1350B**Metric Banjo**

Product number	hose I.D.		Dimensions DN	Dimension		
	in	mm		hole T	H	S
1350B04-10	1/4	6.4	06	M10-1	11	17
1350B04-12	1/4	6.4	06	M12-1,5	12	20
1350B04-14	1/4	6.4	06	M14-1,5	14	24
1350B05-12	5/16	7.9	08	M12-1,5	12	20
1350B05-14	5/16	7.9	08	M14-1,5	14	24
1350B05-16	5/16	7.9	08	M16-1,5	19	28
1350B06-16	3/8	9.5	10	M16-1,5	19	28
1350B06-18	3/8	9.5	10	M18-1,5	20	32
1350B08-18	1/2	12.7	13	M18-1,5	20	32
1350B08-22	1/2	12.7	13	M22-1,5	23	36
1350B10-18	5/8	15.9	16	M18-1,5	20	32

Analytic Index

001C	11	0550	51
0022	12	0650	52
012N	13	0650S	52
0001	14	0750	53
0002	15	0750S	53
0009	16	0035	54
004H	16	0135	55
OSI4	17	0400	56
BMC1	17	0100	57
BMC2	18	0200	58
0007	18	S350	59
0008	19	S050	60
0003	19	S05T	61
PTFE	20	S150	62
PTFE-C	20	S15S	63
0345	21	S250	64
0060	22	1260	65
0350	23	1060	66
035G	24	1160	67
0050	25	FS3L	67
0051	25	S003	68
0058	25	1310	69
0051D	26	1110	70
0150	27	1210	71
0151	27	FS6L	71
0158	27	S006	72
0250	28	130S	72
0251	28	110S	73
0258	28	120S	73
2321	29	1250	74
2300	29	1050	74
0041	30	1150	74
0048	30	0940	75
0141	31	0990S	76
0148	31	0930	76
0241	32	0980S	77
0248	32	0920	77
0360	33	0030	78
0370	34	FK50	78
037G	35	FN50	79
N051	35	FN51	79
0850	36	1400	80
0900	37	1600	81
0901	37	1600-00	81
0902	37	1350	82
0901D	38	1650	83
0950	39	D050	84
0951	39	G500	85
0952	39	ONI4	90
1000	40	ONI6	90
1001	40	0370N	91
1002	40	0350N	91
095S	41	0050N 0051N	92
2971	41	0150N 0151N	93
0385	42	0250N 0251N	94
0500	43	0500N	95
0085	44	0085N	96
0185	45	0185N	96
0285	46	0285N	97
0450	47	0450N	97
0084	48	0084N	98
0184	49	0184N	98
0284	50	0284N	99

Analytic Index

0850N	100	0184M	141
0900N 0901N	101	P050	144
0950N 0951N	102	P150	144
0955N	102	BA	145
1000N 1001N	103	0345B	146
S350N	104	0350B	147
S05TN	104	0051B	148
S150N	105	0151B	149
S155N	105	0251B	150
S250N	106	1350B	151
1250N	106		
1050N	107		
1150N	107		
1300N	108		
1100N	108		
1200N	109		
1305N	109		
1105N	110		
1205N	111		
004N	116		
0042	116		
0013	117		
00J4	117		
00J6	117		
0370H	118		
0350H	118		
0050H	119		
0150H	119		
0250H	120		
0850H	120		
0900H	121		
1000H	121		
0450H	122		
0084H	122		
0184H	123		
0284H	123		
S350H	124		
S05TH	124		
S150H	125		
S250H	125		
1250H	126		
1050H	126		
1150H	127		
1300H	128		
1100H	129		
1200H	130		
1305H	130		
1105H	131		
1205H	131		
D050H	132		
00Y4	136		
00Y6	136		
0019	136		
0050Y	137		
0370Y	137		
0084Y	138		
002M	138		
0900M	139		
0950M	139		
0050M	139		
0150M	140		
0370M	140		
0084M	140		

Sections Index

Inserto Standard

Boccola a Pressare (non skive)	11	Curva Metrica 45° cono 24° Serie Pesante	50
Boccola a Pressare (non skive)	12	Femmina Metrica Tubolare Diritta	51
Boccola a Pressare	13	Femmina Metrica Tubolare 90°	52
Boccola a Pressare (skive)	14	Femmina Metrica Tubolare 90° (saldato)	52
Boccola a Pressare (skive)	15	Femmina Metrica Tubolare 45°	53
Boccola a Pressare (skive)	16	Femmina Metrica Tubolare 45° (saldato)	53
Boccola a Pressare (skive)	16	Femmina Metrica Cono 24° Serie Leggera Multiseal	54
Boccola a Pressare (non skive)	17	Curva Metrica 90° Cono 24° Serie Leggera Multiseal	55
Boccola a Pressare (non skive)	17	Maschio Metrico Svas.60°	56
Boccola a Pressare (non skive)	18	Femmina Metrica Cono 60°	57
Boccola a Pressare (non skive)	18	Curva Metrica 90° cono 60°	58
Boccola a Pressare (non skive)	18	Maschio ORFS	59
Boccola a Pressare (non skive)	19	Femmina ORFS	60
Boccola a Pressare (non skive)	19	Femmina ORFS doppio esagono	61
Boccola per tubo PTFE	20	Curva ORFS 90°	62
Boccola per tubo PTFE	20	Curva ORFS 90° - ISO SHORT	63
Maschio BSP - Sede Piana	21	Curva ORFS 45°	64
Femmina BSP Sede Piana	22	Flangia Diritta SAE 3000 PSI	65
Maschio BSP svas. 60°	23	Flangia 90° SAE 3000 PSI	66
Maschio BSP Svas.60° - girevole	24	Flangia 45° SAE 3000 PSI	67
Femmina BSP cono 60°	25	Flangia 90° SAE 3000 PSI - Tipo Lungo	67
Femmina BSP cono 60° Dado Rullato	25	Semiflange tagliate - 3000 psi	68
Femmina BSP cono 60° Dado Libero	25	Flangia Diritta SAE 6000 PSI	69
Femmina BSP cono 60° Doppio esagono	26	Flangia 90° SAE 6000 PSI	70
Curva BSP 90° cono 60°	27	Flangia 45° SAE 6000 PSI	71
Curva BSP 90° cono 60° Dado Rullato	27	Flangia 90° SAE 6000 PSI - Tipo Lungo	71
Curva BSP 90° cono 60° Dado Libero	27	Semiflange tagliate - 6000 psi	72
Curva BSP 45° cono 60°	28	Flangia Diritta SUPERCAT	72
Curva BSP 45° cono 60° - Dado rullato	28	Flangia 90° SUPERCAT	73
Curva BSP 45° cono 60° - Dado libero	28	Flangia 45° SUPERCAT	73
Compatta BSP 90° cono 60°	29	Flangia Komatsu diritta	74
Compatta BSP 90° cono 60° - Dado spinato - Welded	29	Flangia Komatsu 90°	74
Femmina BSP cono 60° con O-Ring	30	Flangia Komatsu 45°	74
Femmina BSP cono 60° con O-Ring - Dado Libero	30	Femmina JIS Cono 60° (Komatsu)	75
Curva BSP 90° cono 60° con O-Ring	31	Curva 90° JIS Cono 60° (Komatsu) - saldato	76
Curva BSP 90° cono 60° con O-Ring - Dado Libero	31	Femmina JIS cono 60° (Toyota)	76
Curva BSP 45° cono 60° con O-Ring	32	Curva JIS 90° (Toyota) - saldato	77
Curva BSP 45° cono 60° con O-Ring - Dado libero	32	Femmina JIS cono 60° (Nissan)	77
Maschio BSP svas. 60°	33	Femmina Metrica Cono 24° Serie Francese	78
Maschio NPTF svas. 60°	34	Femmina Tipo 'K' per Idropultrici	78
Maschio NPTF Svas.60° - girevole	35	Inseri Tipo 'K' (per lancia) - Diametro 10	79
Femmina NPSM cono 60° dado rullato	35	Inseri Tipo 'K' (per lancia) - Diametro 11	79
Maschio JIC cono 74°	36	Occhio a Pressare BSP	80
Femmina JIC svas. 74°	37	Bullone forato Gas Doppio	81
Femmina JIC svas. 74° - Dado Rullato	37	Bullone forato Gas	81
Femmina JIC svas. 74° - Dado libero	37	Occhio a Pressare Metrico	82
Femmina JIC svas. 74° - Doppio esagono	38	Bullone forato Metrico	83
Curva JIC 90° svas.74°	39	Giunzione per Tubi Flessibili	84
Curva JIC 90° svas.74° - Dado rullato	39	Gambo a Saldare	85
Curva JIC 90° svas.74° - Dado libero	39	Inserto N	86
Curva JIC 45° svas.74°	40	Boccola a Pressare 4WS (non skive)	90
Curva JIC 45° svas.74° Dado Rullato	40	Boccola a Pressare (non skive)	90
Curva JIC 45° svas.74° Dado libero	40	Maschio NPTF svas. 60°	91
Curva JIC 90° svas.74° - ISO SHORT	41	Maschio BSP svas. 60°	91
Compatta JIC 90° svas.74° - Dado crimpato	41	Femmina BSP cono 60°	92
Maschio SAE O'R Sede Piana	42	Curva BSP 90° cono 60°	93
Maschio Metrico svas. 24° Serie Leggera	43	Curva BSP 45° cono 60°	94
Femmina Metrica cono 24° Serie Leggera	44	Maschio Metrico svas. 24° Serie Leggera	95
Curva Metrica 90° cono 24° Serie Leggera	45	Femmina Metrica cono 24° Serie Leggera	96
Curva Metrica 45° cono 24° Serie Leggera	46	Curva Metrica 90° cono 24° Serie Leggera	96
Maschio Metrico svas. 24° Serie Pesante	47	Curva Metrica 45° cono 24° Serie Leggera	97
Femmina Metrica cono 24° Serie Pesante	48	Maschio Metrico svas. 24° Serie Pesante	97
Curva Metrica 90° cono 24° Serie Pesante	49	Femmina Metrica cono 24° Serie Pesante	98

Sections Index

Curva Metrica 90° cono 24° Serie Pesante	98	Femmina BSP cono 60° Dado Spinato	139
Curva Metrica 45° cono 24° Serie Pesante	99	Curva BSP 90° cono 60° Dado Spinato	140
Maschio JIC cono 74°	100	Maschio NPTF svas. 60°	140
Femmina JIC svas. 74° - Doppio esagono	101	Femmina Metrica cono 24° Serie Pesante	140
Curva JIC 90° svas.74°	102	Curva Metrica 90° cono 24° Serie Pesante	141
Curva JIC 90° svas.74° - ISO SHORT	102	Raccordi bassa pressione	142
Curva JIC 45° svas.74°	103	Femmina BSP cono 60° - UniLock	144
Maschio ORFS	104	Curva 90° BSP cono 60° - UniLock	144
Femmina ORFS doppio esagono	104	Boccola in Acciaio	145
Curva ORFS 90°	105	Maschio BSP - Sede Piana	146
Curva ORFS 90° - ISO SHORT	105	Maschio BSP svas. 60°	147
Curva ORFS 45°	106	Femmina BSP cono 60°	148
Flangia Diritta SAE 3000 PSI	106	Curva 90° BSP cono 60°	149
Flangia 90° SAE 3000 PSI	107	Curva 45° BSP cono 60°	150
Flangia 45° SAE 3000 PSI	107	Occhio a Pressare Metrico	151
Flangia Diritta SAE 6000 PSI	108		
Flangia 90° SAE 6000 PSI	108		
Flangia 45° SAE 6000 PSI	109		
Flangia Diritta SUPERCAT	109		
Flangia 90° SUPERCAT	110		
Flangia 45° SUPERCAT	111		
Inserto Interlock	112		
Boccola a Pressare (skive)	116		
Boccola a Pressare (skive)	116		
Boccola a Pressare (skive)	117		
Boccola a Pressare (skive)	117		
Boccola a Pressare (skive)	117		
Maschio NPTF svas. 60°	118		
Maschio BSP svas. 60°	118		
Femmina BSP cono 60° Dado Spinato	119		
Curva BSP 90° cono 60° Dado Spinato	119		
Curva BSP 45° cono 60° Dado Spinato	120		
Maschio JIC cono 74°	120		
Femmina JIC svas. 74° Dado Spinato	121		
Curva JIC 45° svas. 74° Dado Spinato	121		
Maschio Metrico svas. 24° Serie Pesante	122		
Femmina Metrica cono 24° Serie Pesante	122		
Curva Metrica 90° cono 24° Serie Pesante	123		
Curva Metrica 45° cono 24° Serie Pesante	123		
Maschio ORFS	124		
Femmina ORFS doppio esagono	124		
Curva ORFS 90°	125		
Curva ORFS 45°	125		
Flangia Diritta SAE 3000 PSI	126		
Flangia 90° SAE 3000 PSI	126		
Flangia 45° SAE 3000 PSI	127		
Flangia Diritta SAE 6000 PSI	128		
Flangia 90° SAE 6000 PSI	129		
Flangia 45° SAE 6000 PSI	130		
Flangia Diritta SUPERCAT	130		
Flangia 90° SUPERCAT	131		
Flangia 45° SUPERCAT	131		
Giunzione per Tubi Flessibili	132		
Inserto Hyblast / Multispiral	133		
Boccola a Pressare (skive)	136		
Boccola a Pressare (skive)	136		
Boccola a Pressare (skive)	136		
Femmina BSP cono 60° Dado Spinato	137		
Maschio NPTF svas. 60°	137		
Femmina Metrica cono 24° Serie Pesante	138		
Boccola a Pressare (skive)	138		
Femmina JIC svas. 74° Dado Spinato	139		
Curva JIC 90° svas. 74° Dado Spinato	139		



INTERPUMP

FLUID SOLUTIONS 

Powered by I.M.M. Hydraulics



I.M.M. Hydraulics Spa
interpumpfluidsolutions.com

Via Italia, 49-51
66041 - Atessa (Ch) - Italy
T. +39 (0) 0872 889225
F. +39 (0) 0872 889226

