

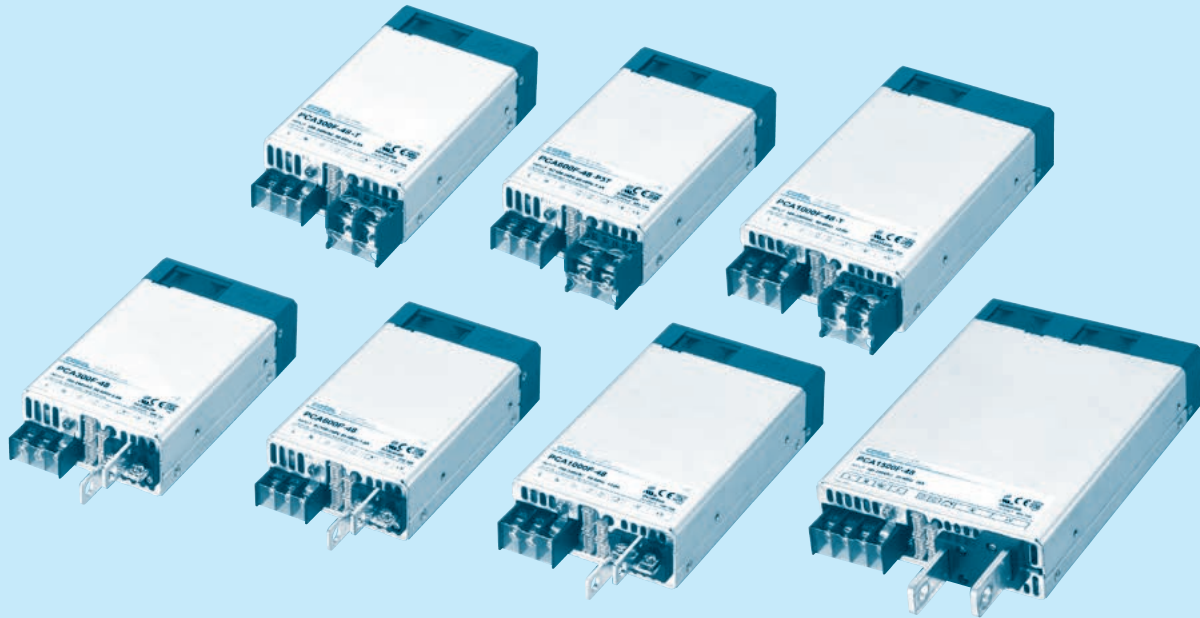

# PCA-series



PCA300F

PCA600F

PCA1000F

PCA1500F

## Feature

- Low profile (41mm, 1.61 inch = meet 1U height)
- Universal input 85 - 264VAC  
(Refer to "Input voltage Derating")
- DC input 88 - 370VDC possible : Excluding PCA1000F and PCA1500F  
(Refer to "Input voltage Derating")
- For medical electric equipment (ANSI/AAMI ES60601-1, EN60601-1 3rd)
- Medical Isolation Grade 2MOPP
- With AUX output 12V 0.1A (Voltage adjustable range 5 - 12V)
- Constant current function
- Output voltage can be adjusted to near 0V (the item 2.6 on Instruction Manual)
- With various alarms
- Parallel Operation / N+1 Parallel Redundancy Operation possible
- Monitoring function and various setting values can be changed by communication (the item 2.11 on Instruction Manual)
- UL508 (Optional)

## Safety agency approval

- UL62368-1, C-UL (CSA62368-1), EN62368-1, ANSI/AAMI ES60601-1, EN60601-1 3rd
- UL508 (Optional)

## Up to 5-year warranty (Refer to Instruction Manual)

## CE marking

- Low Voltage Directive
- RoHS Directive

## UKCA marking

- Electrical Equipment Safety Regulations
- RoHS Regulations

## EMI

- PCA300F, PCA600F  
Complies with FCC-B, CISPR32-B, EN55011-B, EN55032-B, VCCI-B
- PCA1000F, PCA1500F  
Complies with FCC-A, CISPR32-A, EN55011-A, EN55032-A, VCCI-A

## EMS Compliance : EN61204-3, EN61000-6-2

IEC60601-1-2 (2014), EN60601-1-2 (2015)

- EN61000-4-2
- EN61000-4-3
- EN61000-4-4
- EN61000-4-5
- EN61000-4-6
- EN61000-4-8
- EN61000-4-11

# PCA300F

PC A 300 F -5 -□

① ② ③ ④ ⑤ ⑥

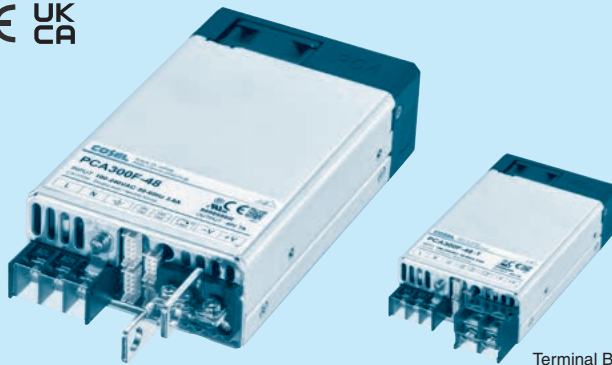
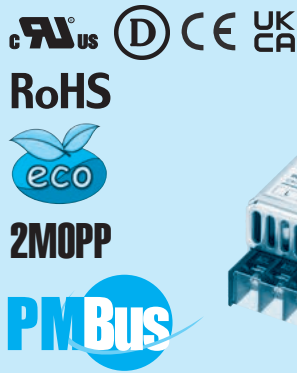

Example recommended EMI/EMC filter  
NAC-06-472



High voltage pulse noise type : NAP series  
Low leakage current type : NAM series  
Low profile type : EAC series

\*A higher current rating EMI/EMC filter may be recommended in view of the other devices that could be connected in parallel with the power supply.

- ① Series name
- ② Single output
- ③ Output wattage
- ④ Universal input
- ⑤ Output voltage
- ⑥ Optional \*7
- C :with Coating
- G :Low leakage current
- T :Terminal Block Style
- I :with PMBus interface
- F2 :Reverse air exhaust type
- P3 :Master-slave Operation
- W1 :Alarm function
- T5 :UL508

For option details, refer to instruction manual 6.1.

\*Make sure necessary tests will be carried out on your end equipment with the power supply installed in accordance with any required EMC/EMI regulations.

MODEL	PCA300F-5	PCA300F-12	PCA300F-15	PCA300F-24	PCA300F-32	PCA300F-48
MAX OUTPUT WATTAGE[W]	300	324	330	336	320	336
DC OUTPUT	5V 60A	12V 27A	15V 22A	24V 14A	32V 10A	48V 7A

## SPECIFICATIONS

MODEL		PCA300F-5	PCA300F-12	PCA300F-15	PCA300F-24	PCA300F-32	PCA300F-48	
INPUT	VOLTAGE	[VAC] 85 - 264 1 φ						
		[VDC] *1 88 - 370						
	CURRENT[A]	ACIN 100V 3.8typ						
		ACIN 230V 1.6typ						
	FREQUENCY[Hz]	50/60 (45 - 66)						
	EFFICIENCY[%]	ACIN 100V	(Io=50%) 86typ	87typ	87typ	88typ	88typ	88typ
			(Io=100%) 87typ	88typ	88typ	89typ	89typ	89typ
		ACIN 230V	(Io=50%) 87typ	88typ	88typ	89typ	89typ	89typ
			(Io=100%) 89typ	90typ	90typ	91typ	91typ	91typ
	POWER FACTOR	ACIN 100V 0.98typ (Io=100%)						
ACIN 230V 0.95typ (Io=100%)								
INRUSH CURRENT[A]	ACIN 100V*2 20/40 typ (Io=100%) (Primary inrush current / Secondary inrush current) (More than 3 sec. to re-start)							
	ACIN 230V*2 40/40 typ (Io=100%) (Primary inrush current / Secondary inrush current) (More than 3 sec. to re-start)							
LEAKAGE CURRENT[ma]	0.5max (ACIN 240V 60Hz, Io=100%, According to IEC60601-1)							
OUTPUT	VOLTAGE[V]	5	12	15	24	32	48	
	CURRENT[A]	60	27	22	14	10	7	
	LINE REGULATION[mV]	20max	48max	60max	96max	128max	192max	
	LOAD REGULATION[mV]	40max	100max	120max	150max	150max	480max	
	RIPPLE[mVp-p]	0 to +50°C *3*4 160max	240max	240max	240max	320max	480max	
		-20 to 0°C *3 280max	320max	320max	320max	420max	640max	
	RIPPLE NOISE[mVp-p]	0 to +50°C *3*4 240max	300max	300max	300max	400max	600max	
		-20 to 0°C *3 320max	360max	360max	360max	480max	720max	
	TEMPERATURE REGULATION[mV]	0 to +50°C *4 50max	120max	150max	240max	320max	480max	
		-20 to +50°C *4 75max	180max	180max	290max	400max	600max	
	DRIFT[mV]	*5 20max	48max	60max	96max	128max	192max	
	START-UP TIME[ms]	700typ (ACIN 100/230V Io=100%)						
	HOLD-UP TIME[ms]	20typ (ACIN 230V Io=80%) / 16typ (ACIN 230V Io=100%)						
OUTPUT VOLTAGE ADJUSTMENT RANGE[V]	3.00 to 6.00	7.20 to 14.40	9.00 to 18.00	14.40 to 28.80	19.20 to 38.40	28.80 to 57.60		
OUTPUT VOLTAGE SETTING[V]	5.00 to 5.05	12.00 to 12.12	15.00 to 15.15	24.00 to 24.24	32.00 to 32.32	48.00 to 48.48		
PROTECTION CIRCUIT AND OTHERS	OVERCURRENT PROTECTION	Works over 105% of rating (Recovers automatically, Hiccup overcurrent)						
	OVERVOLTAGE PROTECTION[V]	6.25 to 7.00	15.00 to 16.80	18.75 to 21.00	30.00 to 33.60	40.00 to 44.80	60.00 to 67.20	
	REMOTE SENSING	Provided						
	REMOTE ON/OFF (RC)	Provided						
	DC_OK LAMP	LED (Blue)						
	ALARM LAMP	LED (Orange)						
COMMUNICATION FUNCTION	Provided (Extended UART)							
ISOLATION	INPUT-OUTPUT	AC4,000V 1minute, Cutoff current = 10mA, DC500V 50MΩ min (At Room Temperature) 2MOPP						
	INPUT-FG	AC2,000V 1minute, Cutoff current = 10mA, DC500V 50MΩ min (At Room Temperature) 1MOPP						
	OUTPUT-FG	AC500V 1minute, Cutoff current = 100mA, DC500V 50MΩ min (At Room Temperature)						
	OUTPUT-AUX·RC·PG·INFO·DS·ADDR0·ADDR1·ADDR2	AC500V 1minute, Cutoff current = 100mA, DC500V 50MΩ min (At Room Temperature)						
ENVIRONMENT	OPERATING TEMP., HUMIDITY AND ALTITUDE	-20 to +70°C, 20 - 90%RH (Non condensing)						
	STORAGE TEMP., HUMIDITY AND ALTITUDE	-20 to +75°C, 20 - 90%RH (Non condensing)						
	VIBRATION	10 - 55Hz 19.6m/s <sup>2</sup> (2G) 3minutes period, 60minutes each along X, Y and Z axis						
	IMPACT	196.1m/s <sup>2</sup> (20G) 11ms, once each X, Y and Z axis						
SAFETY AND NOISE REGULATIONS	AGENCY APPROVALS	UL62368-1, EN62368-1, C-UL (equivalent to CAN/CSA-C22.2 No.62368-1), ANSI/AAMI ES60601-1, EN60601-1 3rd, C-UL (equivalent to CAN/CSA-C22.2 No.60601-1), UL508 (Optional), Complies with IEC60601-1-2 4th Ed.						
	CONDUCTED NOISE	Complies with FCC Part15 classB, VCCI-B, CISPR32-B, EN55011-B, EN55032-B						
	HARMONIC ATTENUATOR *6	Complies with IEC61000-3-2 (class A)						

## SPECIFICATIONS

OTHERS	CASE SIZE/WEIGHT	89 X 41 X 152mm [3.50 X 1.61 X 5.98 inches] (without terminal block and screw) (W X H X D) / 840g max
	COOLING METHOD	Forced cooling (internal fan)

- \*1 DC input safety agency approvals deleted.
- \*2 The value is primary surge. The current of input surge to a built-in EMI/EMS Filter(0.2ms or less) is excluded.
- \*3 Measured by 20MHz oscilloscope or Ripple-Noise meter (equivalent to KEISOKU-GIKEN:RM103). Please refer to the instruction manual 1.2.
- \*4 5V output product, the maximum temperature of 40°C.
- \*5 Drift is the change in DC output for an eight hours period after a half-hour warm-up at 25°C.
- \*6 Please contact us about another class.
- \*7 The listed options may affect the published standard specifications. Please contact us for detailed product specifications and safety approvals.
- \* A sound may occur from power supply at pulse loading.

### Features

- Low profile (41mm, 1.61 inch = meet 1U height)
- Universal input 85 - 264VAC
- DC input 88 - 370VDC possible
- For medical electric equipment (ANSI/AAMI ES60601-1, EN60601-1 3rd, IEC60601-1-2 4th Ed.)
- Medical Isolation Grade 2MOPP
- With AUX output 12V 0.1A (Voltage adjustable range 5 - 12V)
- Constant current function
- Output voltage can be adjusted to near 0V (the item 2.6 on Instruction Manual)
- With various alarms
- Parallel Operation / N+1 Parallel Redundancy Operation possible
- Monitoring function and various setting values can be changed by communication (the item 2.11 on Instruction Manual)
- Complies with SEMI F47 (the item 2.1 on Instruction Manual)
- UL508 approval

### Block diagram

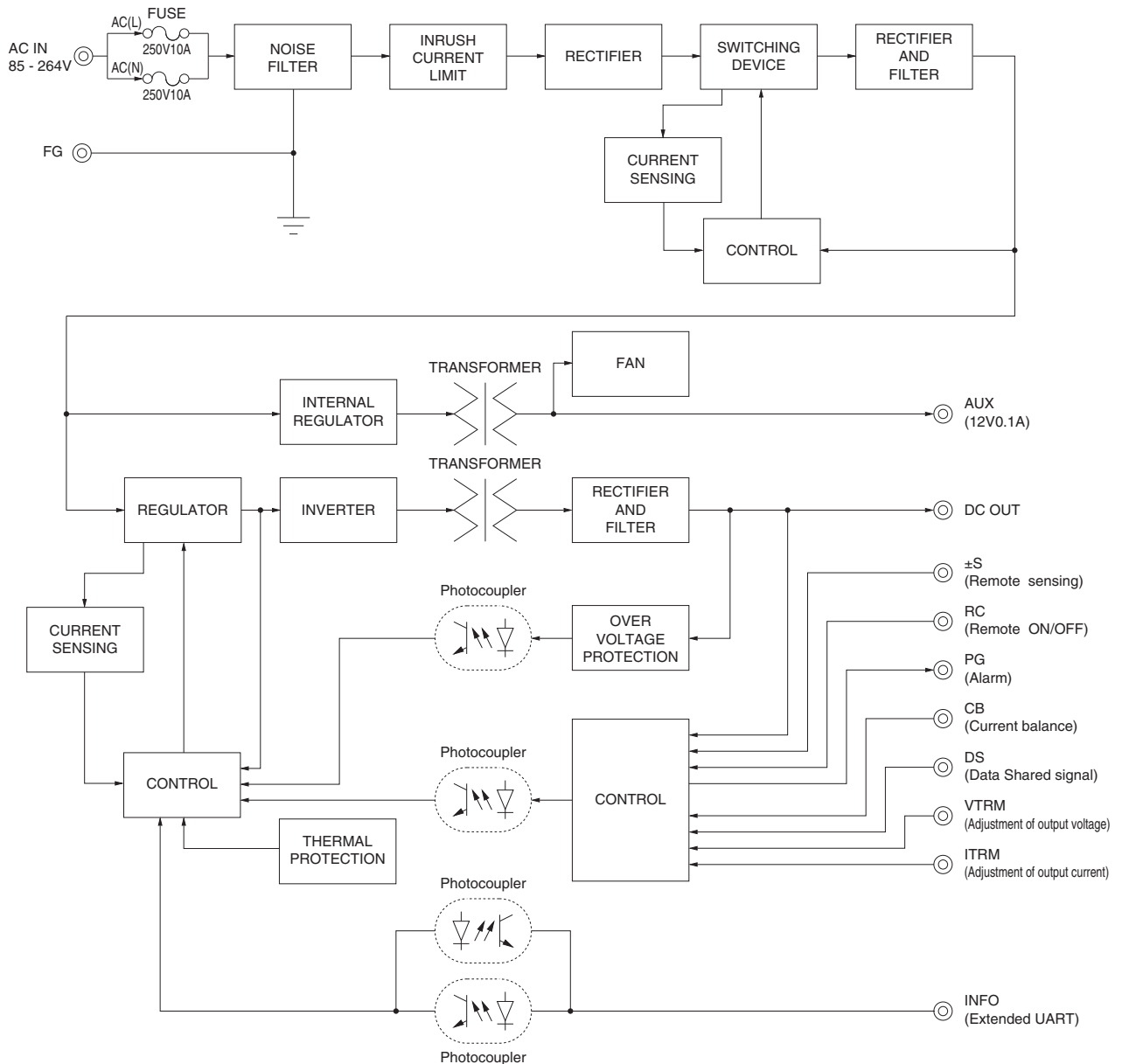

## External view

<PCA300F-□ (Bus Bar Style) >

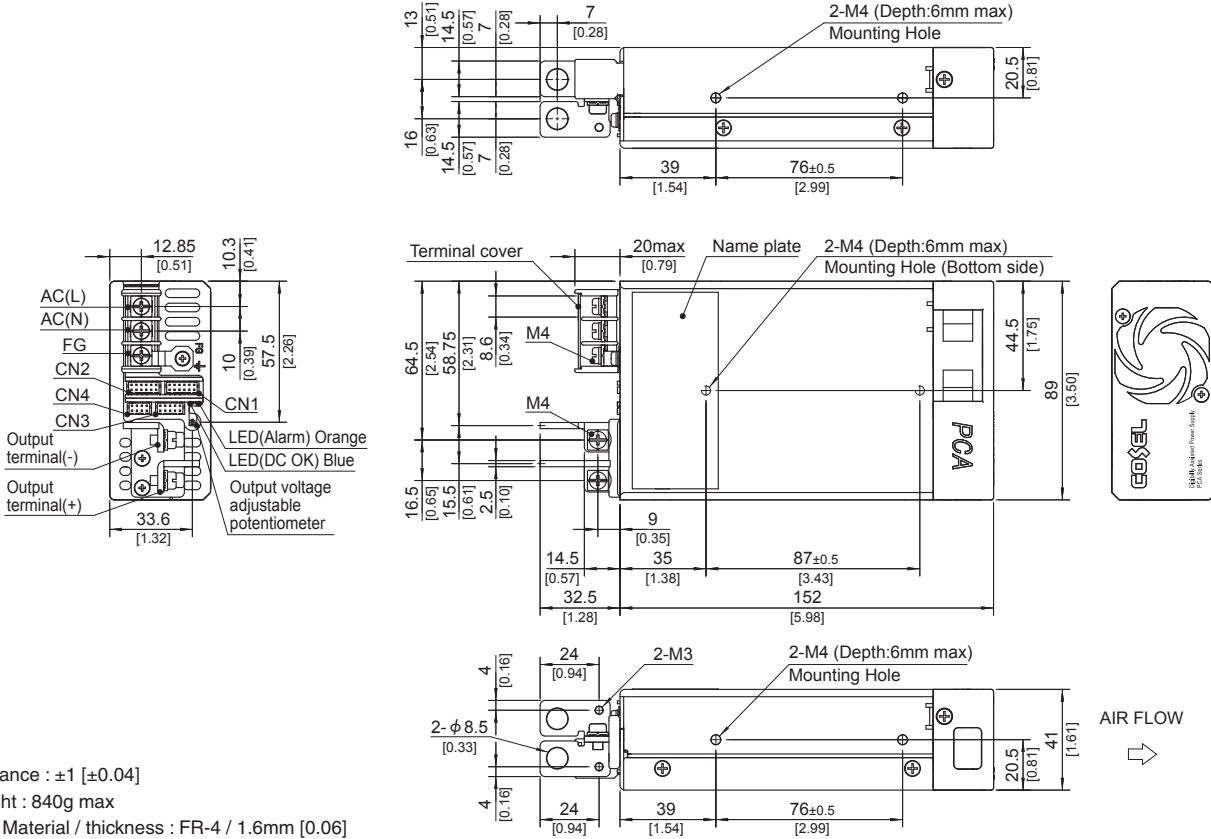

- ※ Tolerance : ±1 [±0.04]
- ※ Weight : 840g max
- ※ PCB Material / thickness : FR-4 / 1.6mm [0.06]
- ※ Chassis Material : Aluminum
- ※ Fan cover Material : PBT
- ※ Dimensions in mm, [ ] = inches
- ※ Mounting torque : 1.2N·m max
- ※ Input and output terminal screw tightening torque
  - M3 0.6N·m max
  - M4 1.6N·m max
- ※ Please connect safety ground to FG terminal on the unit.

## External view

### <PCA300F-□-T (Terminal Block Style) >

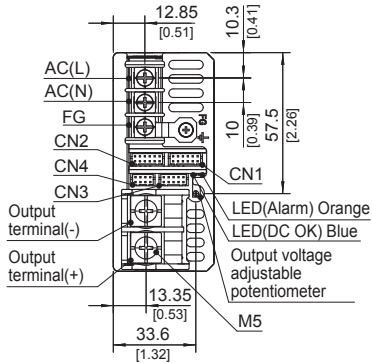

- ※ Tolerance : ±1 [±0.04]
- ※ Weight : 840g max
- ※ PCB Material / thickness : FR-4 / 1.6mm [0.06]
- ※ Chassis Material : Aluminum
- ※ Fan cover Material : PBT
- ※ Dimensions in mm, [ ] = inches
- ※ Mounting torque : 1.2N·m max
- ※ Input and output terminal screw tightening torque  
M4 1.6N·m max  
M5 2.5N·m max
- ※ Please connect safety ground to FG terminal on the unit.

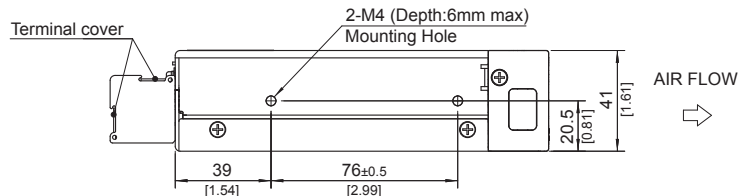
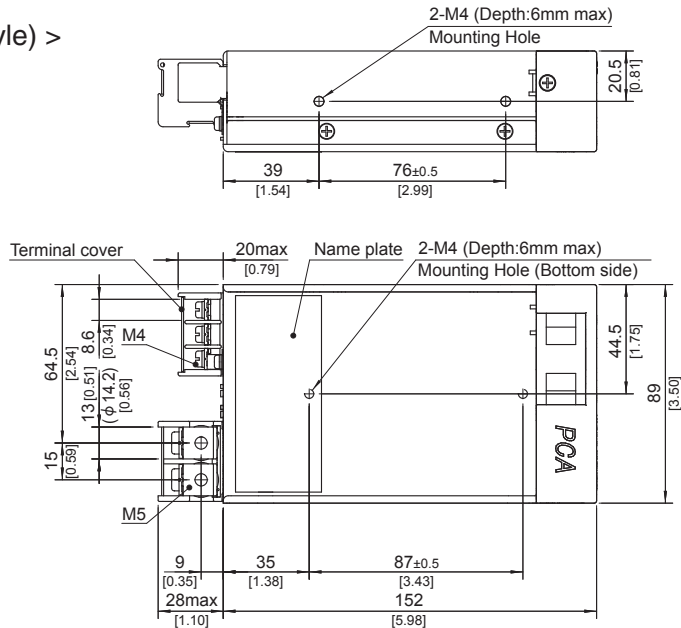

### <PCA300F-□-T5 (Acquired UL508) >

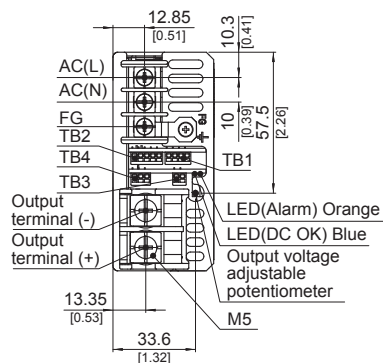

- ※ Tolerance : ±1 [±0.04]
- ※ Weight : 840g max
- ※ PCB Material / thickness : FR-4 / 1.6mm [0.06]
- ※ Chassis Material : Aluminum
- ※ Fan cover Material : PBT
- ※ Dimensions in mm, [ ] = inches
- ※ Mounting torque : 1.2N·m max
- ※ Input and output terminal screw tightening torque  
M4 1.6N·m max  
M5 2.5N·m max
- ※ Please connect safety ground to FG terminal on the unit.

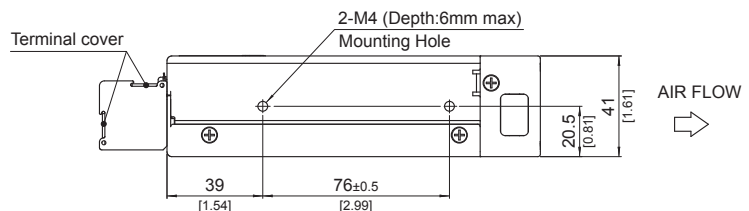
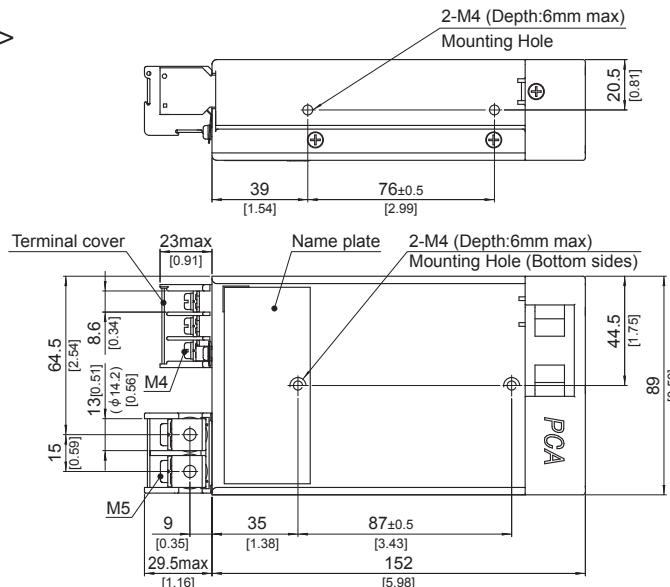

# PCA600F

PC A 600 F -5 -□

① ② ③ ④ ⑤ ⑥



RoHS



2MOPP

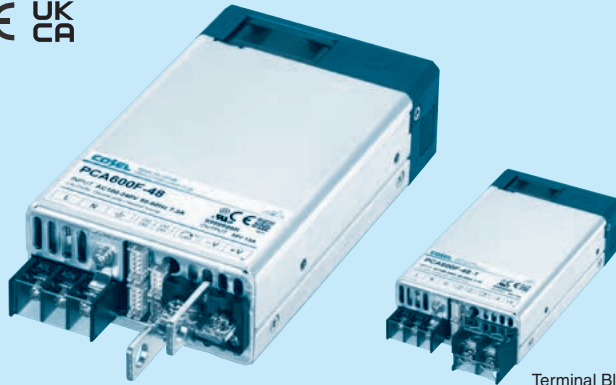

Terminal Block Style

Example recommended EMI/EMC filter  
NAC-16-472



High voltage pulse noise type : NAP series  
Low leakage current type : NAM series  
Low profile type : EAC series

\*A higher current rating EMI/EMC filter may be recommended in view of the other devices that could be connected in parallel with the power supply.

- ① Series name
- ② Single output
- ③ Output wattage
- ④ Universal input
- ⑤ Output voltage
- ⑥ Optional \*7
- C : with Coating
- G : Low leakage current
- T : Terminal Block Style (Only 12V, 15V, 24V, 32V and 48V)
- I : with PMBus interface
- F2 : Reverse air exhaust type
- P3 : Master-slave Operation
- W1 : Alarm function
- T5 : UL508 (Only 12V, 15V, 24V, 32V and 48V)

For option details, refer to instruction manual 6.1.

\*Make sure necessary tests will be carried out on your end equipment with the power supply installed in accordance with any required EMC/EMI regulations.

MODEL	PCA600F-5	PCA600F-12	PCA600F-15	PCA600F-24	PCA600F-32	PCA600F-48
MAX OUTPUT WATTAGE[W]	600	636	645	648	640	624
DC OUTPUT	5V 120A	12V 53A	15V 43A	24V 27A	32V 20A	48V 13A

## SPECIFICATIONS

	MODEL	PCA600F-5	PCA600F-12	PCA600F-15	PCA600F-24	PCA600F-32	PCA600F-48		
INPUT	VOLTAGE	[VAC]	85 - 264 1φ (Output derating is required at less than 90V. Refer to "Derating")						
		[VDC] *1	88 - 370 (Output derating is required at less than 110V. Refer to "Derating")						
	CURRENT[A]	ACIN 100V	7.3typ						
		ACIN 230V	3.2typ						
	FREQUENCY[Hz]		50/60 (45 - 66)						
	EFFICIENCY[%]	ACIN 100V	(Io=50%)	90typ	91typ	91typ	91typ	91typ	91typ
			(Io=100%)	89typ	90typ	90typ	91typ	91typ	91typ
		ACIN 230V	(Io=50%)	92typ	92typ	92typ	93typ	93typ	93typ
			(Io=100%)	91typ	92typ	92typ	93typ	93typ	93typ
	POWER FACTOR	ACIN 100V	0.98typ (Io=100%)						
ACIN 230V		0.95typ (Io=100%)							
INRUSH CURRENT[A]	ACIN 100V*2	20/40 typ (Io=100%) (Primary inrush current / Secondary inrush current) (More than 3 sec. to re-start)							
	ACIN 230V*2	40/40 typ (Io=100%) (Primary inrush current / Secondary inrush current) (More than 3 sec. to re-start)							
LEAKAGE CURRENT[ma]		0.5max (ACIN 240V 60Hz, Io=100%, According to IEC60601-1)							
OUTPUT	VOLTAGE[V]	5	12	15	24	32	48		
	CURRENT[A]	120	53	43	27	20	13		
	LINE REGULATION[mV]	20max	48max	60max	96max	128max	192max		
	LOAD REGULATION[mV]	40max	100max	120max	150max	150max	480max		
	RIPPLE[mVp-p]	0 to +50°C *3*4	160max	240max	240max	240max	320max	480max	
		-20 to 0°C *3	280max	320max	320max	320max	420max	640max	
	RIPPLE NOISE[mVp-p]	0 to +50°C *3*4	240max	300max	300max	300max	400max	600max	
		-20 to 0°C *3	320max	360max	360max	360max	480max	720max	
	TEMPERATURE REGULATION[mV]	0 to +50°C *4	50max	120max	150max	240max	320max	480max	
		-20 to +50°C *4	75max	180max	180max	290max	400max	600max	
	DRIFT[mV]	*5	20max	48max	60max	96max	128max	192max	
	START-UP TIME[ms]		700typ (ACIN 100/230V Io=100%)						
	HOLD-UP TIME[ms]		20typ (ACIN 230V Io=80%) / 16typ (ACIN 230V Io=100%)						
OUTPUT VOLTAGE ADJUSTMENT RANGE[V]		3.00 to 6.00	7.20 to 14.40	9.00 to 18.00	14.40 to 28.80	19.20 to 38.40	28.80 to 57.60		
OUTPUT VOLTAGE SETTING[V]		5.00 to 5.05	12.00 to 12.12	15.00 to 15.15	24.00 to 24.24	32.00 to 32.32	48.00 to 48.48		
PROTECTION CIRCUIT AND OTHERS	OVERCURRENT PROTECTION	Works over 105% of rating (Recovers automatically, Hiccup overcurrent)							
	OVERVOLTAGE PROTECTION[V]	6.25 to 7.00	15.00 to 16.80	18.75 to 21.00	30.00 to 33.60	40.00 to 44.80	60.00 to 67.20		
	REMOTE SENSING	Provided							
	REMOTE ON/OFF (RC)	Provided							
	DC_OK LAMP	LED (Blue)							
	ALARM LAMP	LED (Orange)							
COMMUNICATION FUNCTION	Provided (Extended UART)								
ISOLATION	INPUT-OUTPUT	AC4,000V 1minute, Cutoff current = 10mA, DC500V 50MΩ min (At Room Temperature) 2MOPP							
	INPUT-FG	AC2,000V 1minute, Cutoff current = 10mA, DC500V 50MΩ min (At Room Temperature) 1MOPP							
	OUTPUT-FG	AC500V 1minute, Cutoff current = 100mA, DC500V 50MΩ min (At Room Temperature)							
	OUTPUT - AUX · RC · PG · INFO · DS · ADDR0 · ADDR1 · ADDR2	AC500V 1minute, Cutoff current = 100mA, DC500V 50MΩ min (At Room Temperature)							
ENVIRONMENT	OPERATING TEMP., HUMIDITY AND ALTITUDE	-20 to +70°C, 20 - 90%RH (Non condensing)							
	STORAGE TEMP., HUMIDITY AND ALTITUDE	-20 to +75°C, 20 - 90%RH (Non condensing)							
	VIBRATION	10 - 55Hz 19.6m/s <sup>2</sup> (2G) 3minutes period, 60minutes each along X, Y and Z axis							
	IMPACT	196.1m/s <sup>2</sup> (20G) 11ms, once each X, Y and Z axis							
SAFETY AND NOISE REGULATIONS	AGENCY APPROVALS	UL62368-1, EN62368-1, C-UL (equivalent to CAN/CSA-C22.2 No.62368-1), ANSI/AAMI ES60601-1, EN60601-1 3rd, C-UL (equivalent to CAN/CSA-C22.2 No.60601-1), UL508 (Optional), Complies with IEC60601-1-2 4th Ed.							
	CONDUCTED NOISE	Complies with FCC Part15 classB, VCCI-B, CISPR32-B, EN55011-B, EN55032-B							
	HARMONIC ATTENUATOR *6	Complies with IEC61000-3-2 (class A)							

## SPECIFICATIONS

OTHERS	CASE SIZE/WEIGHT	89 X 41 X 152mm [3.50 X 1.61 X 5.98 inches] (without terminal block and screw) (W X H X D) / 840g max
	COOLING METHOD	Forced cooling (internal fan)

- \*1 DC input safety agency approvals deleted.
- \*2 The value is primary surge. The current of input surge to a built-in EMI/EMS Filter(0.2ms or less) is excluded.
- \*3 Measured by 20MHz oscilloscope or Ripple-Noise meter (equivalent to KEISOKU-GIKEN:RM103). Please refer to the instruction manual 1.2.
- \*4 5V output product, the maximum temperature of 40°C.
- \*5 Drift is the change in DC output for an eight hours period after a half-hour warm-up at 25°C.
- \*6 Please contact us about another class.
- \*7 The listed options may affect the published standard specifications. Please contact us for detailed product specifications and safety approvals.
- \* A sound may occur from power supply at pulse loading.

### Features

- Low profile (41mm, 1.61 inch = meet 1U height)
- Universal input 85 - 264VAC (Refer to “Derating”, when using at 85 - 90VAC)
- DC input 88 - 370VDC possible (Refer to when using at 88 - 110VDC)
- For medical electric equipment (ANSI/AAMI ES60601-1, EN60601-1 3rd, IEC60601-1-2 4th Ed.)
- Medical Isolation Grade 2MOPP
- With AUX output 12V 0.1A (Voltage adjustable range 5 - 12V)
- Constant current function
- Output voltage can be adjusted to near 0V (the item 2.6 on Instruction Manual)
- With various alarms
- Parallel Operation / N+1 Parallel Redundancy Operation possible
- Monitoring function and various setting values can be changed by communication (the item 2.11 on Instruction Manual)
- Complies with SEMI F47 (the item 2.1 on Instruction Manual)
- UL508 approval

### Block diagram

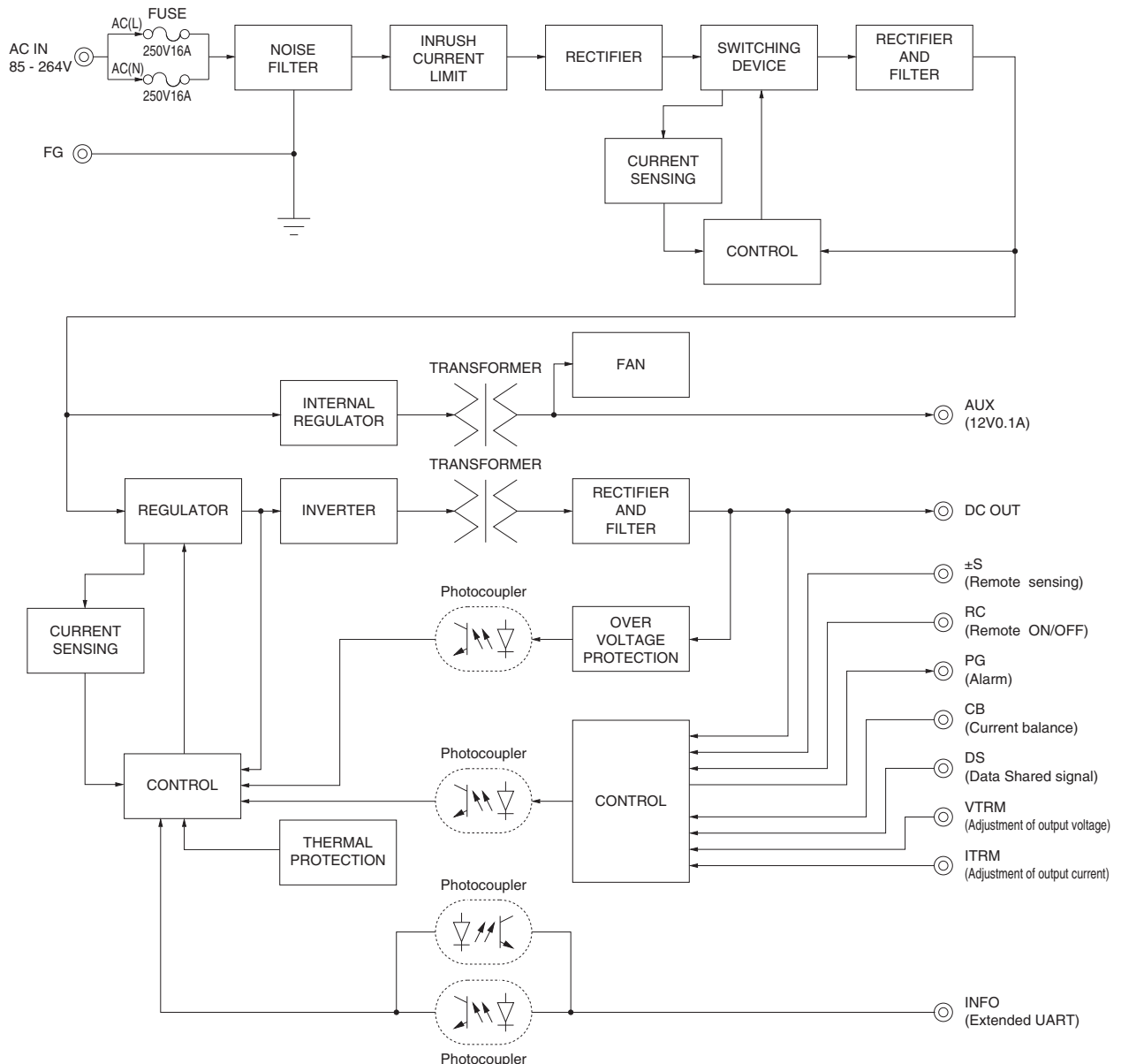

## External view

<PCA600F-□ (Bus Bar Style) >

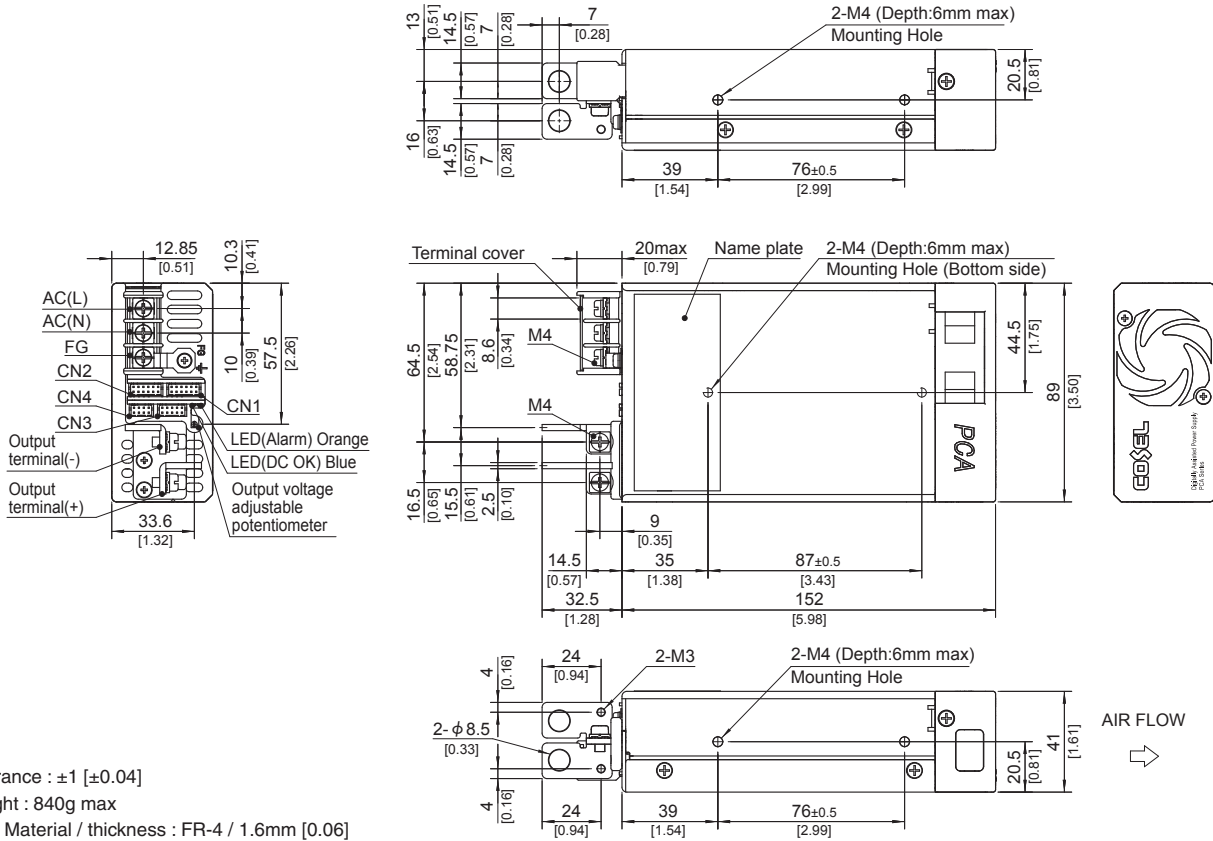

- ※ Tolerance : ±1 [±0.04]
- ※ Weight : 840g max
- ※ PCB Material / thickness : FR-4 / 1.6mm [0.06]
- ※ Chassis Material : Aluminum
- ※ Fan cover Material : PBT
- ※ Dimensions in mm, [ ] = inches
- ※ Mounting torque : 1.2N·m max
- ※ Input and output terminal screw tightening torque
  - M3 0.6N·m max
  - M4 1.6N·m max
- ※ Please connect safety ground to FG terminal on the unit.



External view

<PCA600F-□-T (Terminal Block Style) >

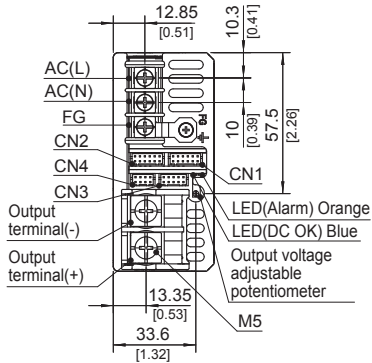

- ※ Tolerance : ±1 [±0.04]
- ※ Weight : 840g max
- ※ PCB Material / thickness : FR-4 / 1.6mm [0.06]
- ※ Chassis Material : Aluminum
- ※ Fan cover Material : PBT
- ※ Dimensions in mm, [ ] = inches
- ※ Mounting torque : 1.2N·m max
- ※ Input and output terminal screw tightening torque
  - M4 1.6N·m max
  - M5 2.5N·m max
- ※ Please connect safety ground to FG terminal on the unit.

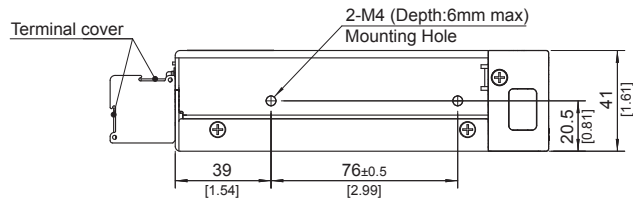
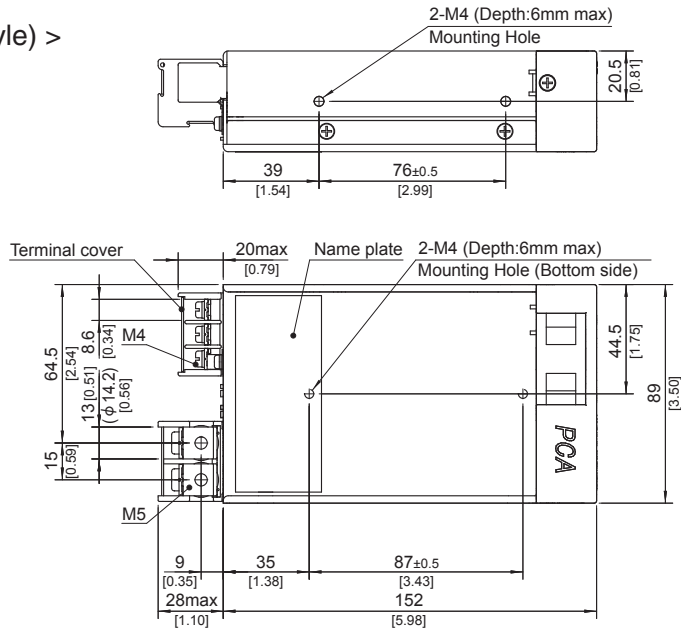

AIR FLOW  
➔

<PCA600F-□-T5 (Acquired UL508) >

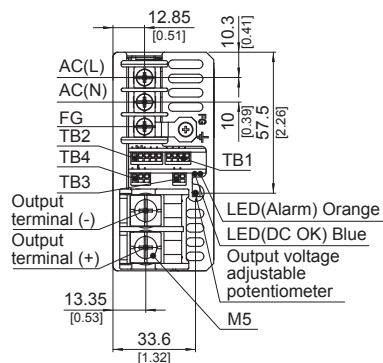

- ※ Tolerance : ±1 [±0.04]
- ※ Weight : 840g max
- ※ PCB Material / thickness : FR-4 / 1.6mm [0.06]
- ※ Chassis Material : Aluminum
- ※ Fan cover Material : PBT
- ※ Dimensions in mm, [ ] = inches
- ※ Mounting torque : 1.2N·m max
- ※ Input and output terminal screw tightening torque
  - M4 1.6N·m max
  - M5 2.5N·m max
- ※ Please connect safety ground to FG terminal on the unit.

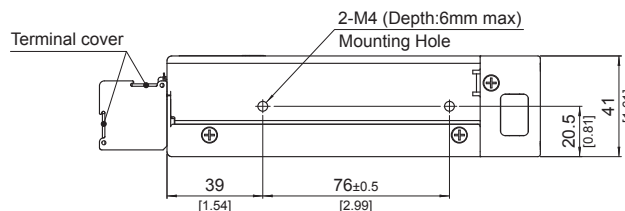
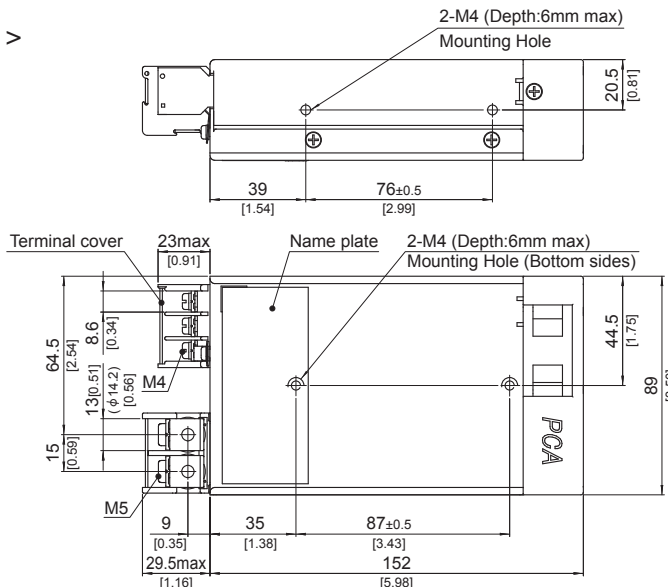

AIR FLOW  
➔

# PCA1000F

PC A 1000 F -5 -□

① ② ③ ④ ⑤ ⑥



RoHS



2MOPP

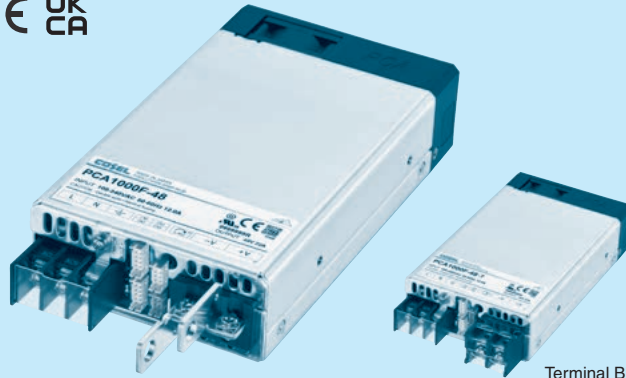

Terminal Block Style

Example recommended EMI/EMC filter  
NAC-20-472



High voltage pulse noise type : NAP series  
Low leakage current type : NAM series  
Low profile type : EAC series

\* A higher current rating EMI/EMC filter may be recommended in view of the other devices that could be connected in parallel with the power supply.

- ① Series name
- ② Single output
- ③ Output wattage
- ④ Universal input
- ⑤ Output voltage
- ⑥ Optional \*6
- C : with Coating
- G : Low leakage current
- T : Terminal Block Style (Only 24V, 32V and 48V)
- I : with PMBus interface
- F2 : Reverse air exhaust type
- P3 : Master-slave Operation
- W1 : Alarm function
- E1 : EMI classB (Only 24V, 32V and 48V)
- T5 : UL508 (Only 24V, 32V and 48V)

For option details, refer to instruction manual 6.1.

\* Make sure necessary tests will be carried out on your end equipment with the power supply installed in accordance with any required EMC/EMI regulations.

MODEL	PCA1000F-5	PCA1000F-12	PCA1000F-15	PCA1000F-24	PCA1000F-32	PCA1000F-48
MAX OUTPUT WATTAGE[W]	1000	1056	1050	1056	1056	1056
DC OUTPUT	5V 200A	12V 88A	15V 70A	24V 44A	32V 33A	48V 22A

## SPECIFICATIONS

	MODEL	PCA1000F-5	PCA1000F-12	PCA1000F-15	PCA1000F-24	PCA1000F-32	PCA1000F-48	
INPUT	VOLTAGE [VAC]	85 - 264 1 φ (Output derating is required at less than 90V. Refer to "Derating")						
	CURRENT[A]	ACIN 100V	12.0typ					
		ACIN 230V	5.3typ					
	FREQUENCY[Hz]	50/60 (45 - 66)						
	EFFICIENCY[%]	ACIN 100V	(Io=50%)	90typ	91typ	91typ	91typ	91typ
			(Io=100%)	89typ	90typ	90typ	91typ	91typ
		ACIN 230V	(Io=50%)	92typ	92typ	92typ	93typ	93typ
			(Io=100%)	91typ	92typ	92typ	93typ	93typ
	POWER FACTOR	ACIN 100V	0.98typ (Io=100%)					
		ACIN 230V	0.95typ (Io=100%)					
INRUSH CURRENT[A]	ACIN 100V*1	20/40 typ (Io=100%) (Primary inrush current / Secondary inrush current) (More than 3 sec. to re-start)						
	ACIN 230V*1	40/40 typ (Io=100%) (Primary inrush current / Secondary inrush current) (More than 3 sec. to re-start)						
LEAKAGE CURRENT[ma]	0.5max (ACIN 240V 60Hz, Io=100%, According to IEC60601-1)							
OUTPUT	VOLTAGE[V]	5	12	15	24	32	48	
	CURRENT[A]	200	88	70	44	33	22	
	LINE REGULATION[mV]	20max	48max	60max	96max	128max	192max	
	LOAD REGULATION[mV]	40max	100max	120max	150max	150max	480max	
	RIPPLE[mVp-p]	0 to +50°C *2*3	160max	240max	240max	240max	320max	480max
		-20 to 0°C *2	280max	320max	320max	320max	420max	640max
	RIPPLE NOISE[mVp-p]	0 to +50°C *2*3	240max	300max	300max	300max	400max	600max
		-20 to 0°C *2	320max	360max	360max	360max	480max	720max
	TEMPERATURE REGULATION[mV]	0 to +50°C *3	50max	120max	150max	240max	320max	480max
		-20 to +50°C *3	75max	180max	180max	290max	400max	600max
	DRIFT[mV]	*4	20max	48max	60max	96max	128max	192max
	START-UP TIME[ms]	700typ (ACIN 100/230V Io=100%)						
	HOLD-UP TIME[ms]	20typ (ACIN 230V Io=80%) / 16typ (ACIN 230V Io=100%)						
OUTPUT VOLTAGE ADJUSTMENT RANGE[V]	3.00 to 6.00	7.20 to 14.40	9.00 to 18.00	14.40 to 28.80	19.20 to 38.40	28.80 to 57.60		
OUTPUT VOLTAGE SETTING[V]	5.00 to 5.05	12.00 to 12.12	15.00 to 15.15	24.00 to 24.24	32.00 to 32.32	48.00 to 48.48		
PROTECTION CIRCUIT AND OTHERS	OVERCURRENT PROTECTION	Works over 105% of rating (Recovers automatically, Hiccup overcurrent)						
	OVERVOLTAGE PROTECTION[V]	6.25 to 7.00	15.00 to 16.80	18.75 to 21.00	30.00 to 33.60	40.00 to 44.80	60.00 to 67.20	
	REMOTE SENSING	Provided						
	REMOTE ON/OFF (RC)	Provided						
	DC_OK LAMP	LED (Blue)						
	ALARM LAMP	LED (Orange)						
COMMUNICATION FUNCTION	Provided (Extended UART)							
ISOLATION	INPUT-OUTPUT	AC4,000V 1minute, Cutoff current = 10mA, DC500V 50MΩ min (At Room Temperature) 2MOPP						
	INPUT-FG	AC2,000V 1minute, Cutoff current = 10mA, DC500V 50MΩ min (At Room Temperature) 1MOPP						
	OUTPUT-FG	AC500V 1minute, Cutoff current = 100mA, DC500V 50MΩ min (At Room Temperature)						
	OUTPUT-AUX · RC · PG · INFO · DS · ADDR0 · ADDR1 · ADDR2	AC500V 1minute, Cutoff current = 100mA, DC500V 50MΩ min (At Room Temperature)						
ENVIRONMENT	OPERATING TEMP., HUMIDITY AND ALTITUDE	-20 to +70°C, 20 - 90%RH (Non condensing)						
	STORAGE TEMP., HUMIDITY AND ALTITUDE	-20 to +75°C, 20 - 90%RH (Non condensing)						
	VIBRATION	10 - 55Hz 19.6m/s <sup>2</sup> (2G) 3minutes period, 60minutes each along X, Y and Z axis						
	IMPACT	196.1m/s <sup>2</sup> (20G) 11ms, once each X, Y and Z axis						
SAFETY AND NOISE REGULATIONS	AGENCY APPROVALS	UL62368-1, EN62368-1, C-UL (equivalent to CAN/CSA-C22.2 No.62368-1), ANSI/AAMI ES60601-1, EN60601-1 3rd, C-UL (equivalent to CAN/CSA-C22.2 No.60601-1), UL508 (Optional), Complies with IEC60601-1-2 4th Ed.						
	CONDUCTED NOISE	Complies with FCC Part15 classA, VCCI-A, CISPR32-A, EN55011-A, EN55032-A						
	HARMONIC ATTENUATOR *5	Complies with IEC61000-3-2 (class A)						

## SPECIFICATIONS

OTHERS	CASE SIZE/WEIGHT	102×41×178mm [4.02×1.61×7.01 inches] (without terminal block and screw) (W×H×D) / 1.2kg max
	COOLING METHOD	Forced cooling (internal fan)

- \*1 The value is primary surge. The current of input surge to a built-in EMI/EMS Filter(0.2ms or less) is excluded.
- \*2 Measured by 20MHz oscilloscope or Ripple-Noise meter (equivalent to KEISOKU-GIKEN:RM103). Please refer to the instruction manual 1.2.
- \*3 5V, 12V, 15V output product, the maximum temperature of 40°C.
- \*4 Drift is the change in DC output for an eight hours period after a half-hour warm-up at 25°C.
- \*5 Please contact us about another class.
- \*6 The listed options may affect the published standard specifications. Please contact us for detailed product specifications and safety approvals.
- \* A sound may occur from power supply at pulse loading.

### Features

- Low profile (41mm, 1.61 inch = meet 1U height)
- Universal input 85 - 264VAC (Refer to “Derating”, when using at 85 - 90VAC)
- For medical electric equipment (ANSI/AAMI ES60601-1, EN60601-1 3rd, IEC60601-1-2 4th Ed.)
- Medical Isolation Grade 2MOPP
- With AUX output 12V 0.1A (Voltage adjustable range 5 - 12V)
- Constant current function
- Output voltage can be adjusted to near 0V (the item 2.6 on Instruction Manual)
- With various alarms
- Parallel Operation / N+1 Parallel Redundancy Operation possible
- Monitoring function and various setting values can be changed by communication (the item 2.11 on Instruction Manual)
- Complies with SEMI F47 (the item 2.1 on Instruction Manual)
- UL508 approval

### Block diagram

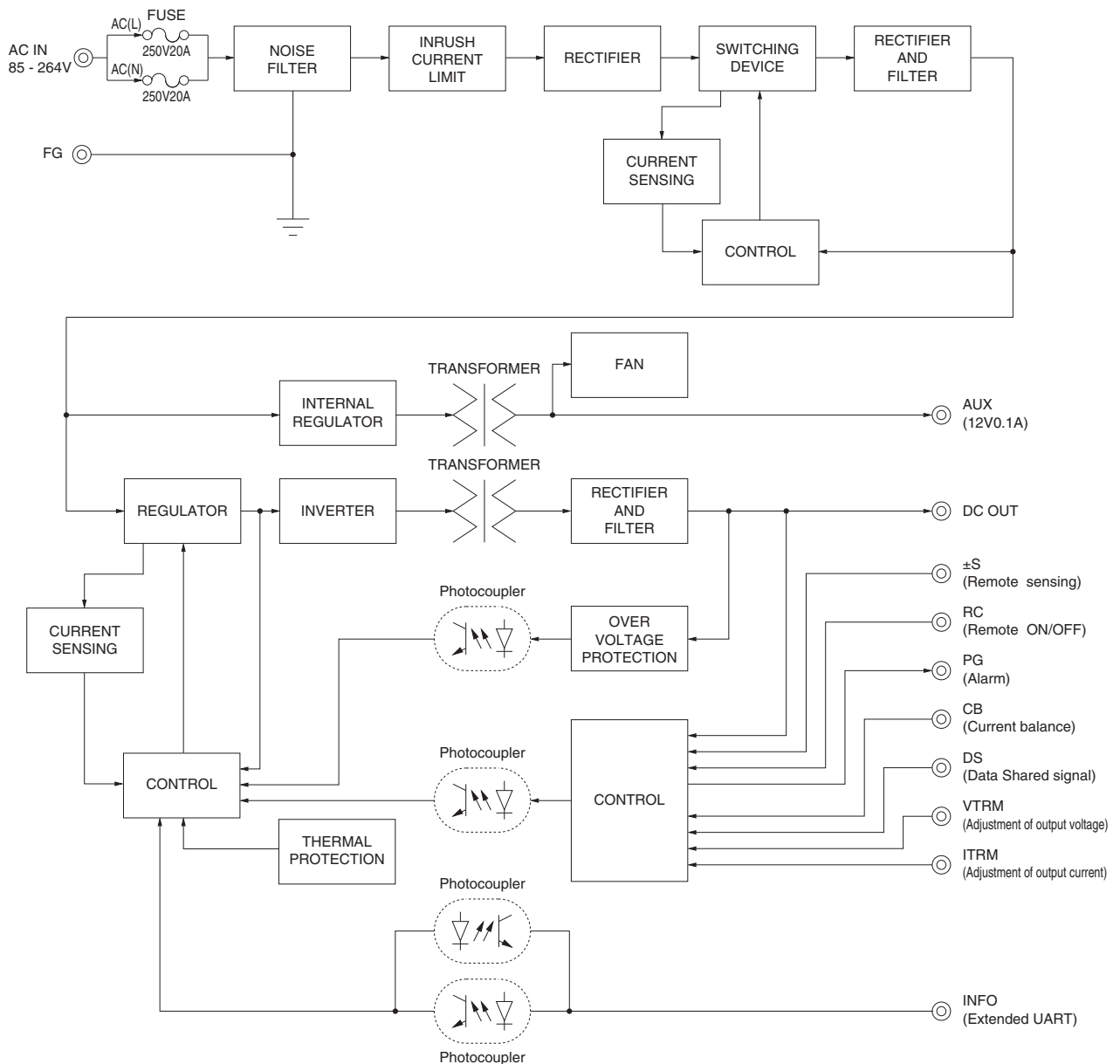

External view

<PCA1000F-□ (Bus Bar Style) >

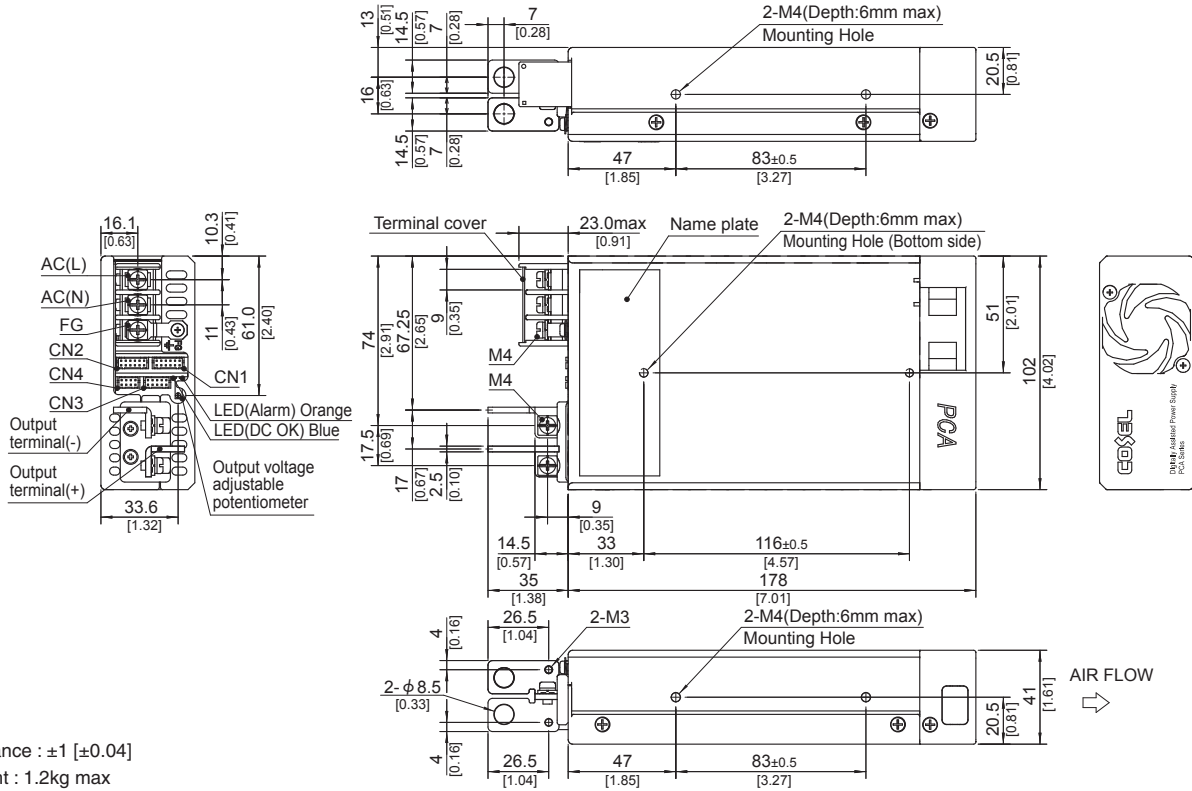

- ※ Tolerance : ±1 [±0.04]
- ※ Weight : 1.2kg max
- ※ PCB Material / thickness : FR-4 / 1.6mm [0.06]
- ※ Chassis Material : Aluminum
- ※ Fan cover Material : PBT
- ※ Dimensions in mm, [ ] = inches
- ※ Mounting torque : 1.2N·m max
- ※ Input and output terminal screw tightening torque
  - M3 0.6N·m max
  - M4 1.6N·m max
- ※ Please connect safety ground to FG terminal on the unit.

## External view

### <PCA1000F-□-T (Terminal Block Style) >

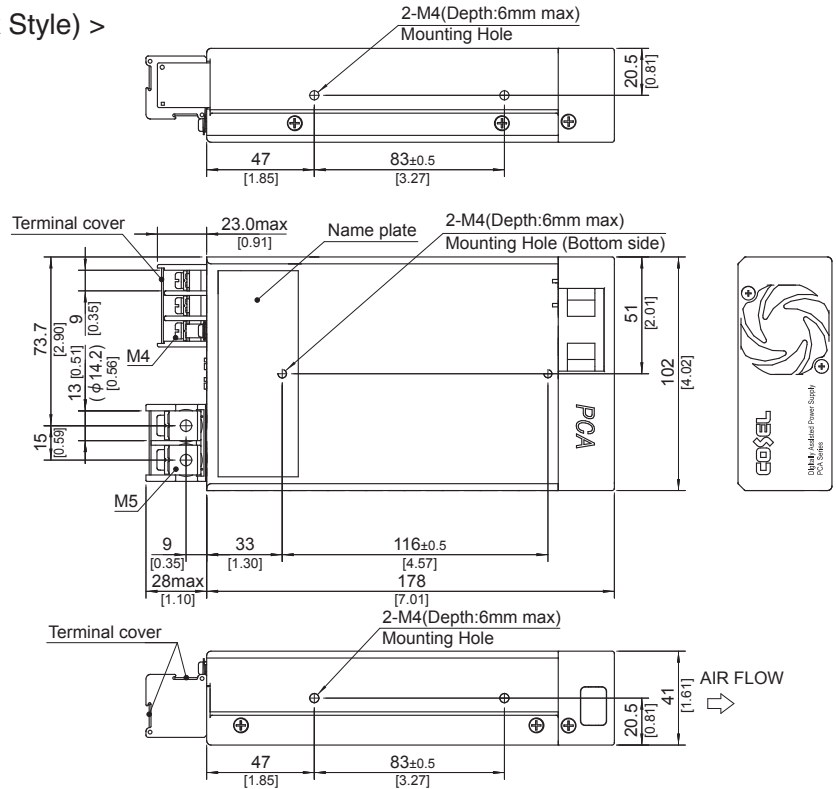
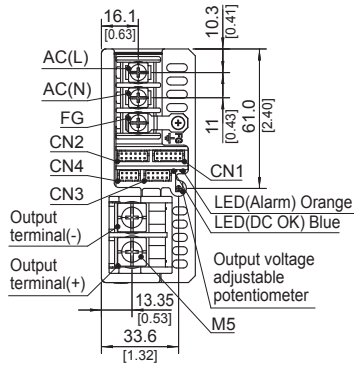

- ※ Tolerance : ±1 [±0.04]
- ※ Weight : 1.2kg max
- ※ PCB Material / thickness : FR-4 / 1.6mm [0.06]
- ※ Chassis Material : Aluminum
- ※ Fan cover Material : PBT
- ※ Dimensions in mm, [ ] = inches
- ※ Mounting torque : 1.2N·m max
- ※ Input and output terminal screw tightening torque
  - M4 1.6N·m max
  - M5 2.5N·m max
- ※ Please connect safety ground to FG terminal on the unit.

### <PCA1000F-□-T5 (Acquired UL508) >

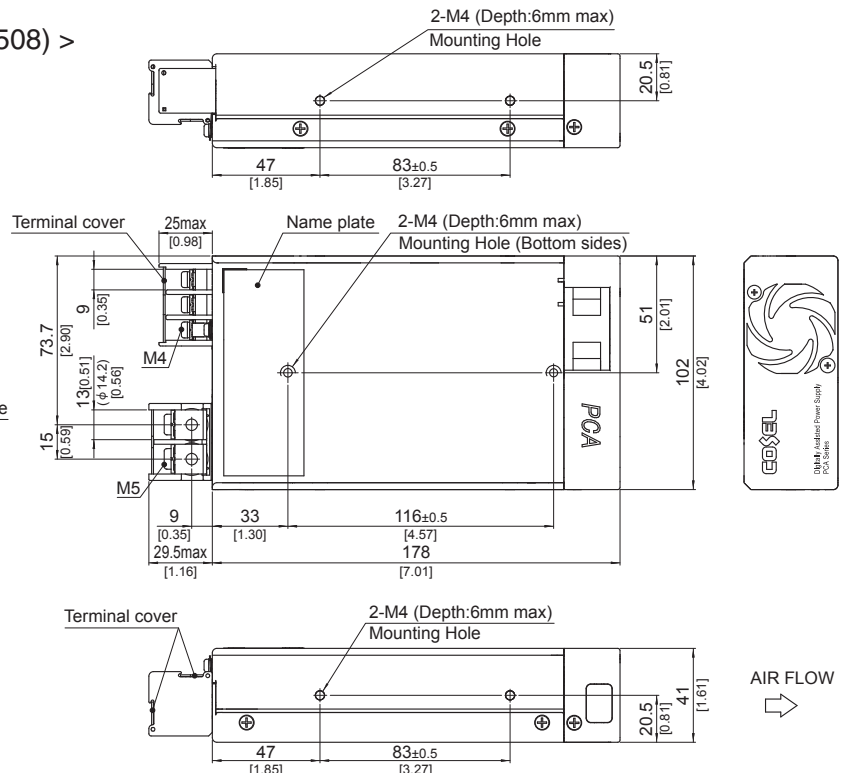
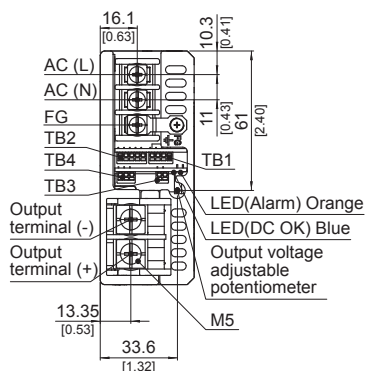

- ※ Tolerance : ±1 [±0.04]
- ※ Weight : 1.2kg max
- ※ PCB Material / thickness : FR-4 / 1.6mm [0.06]
- ※ Chassis Material : Aluminum
- ※ Fan cover Material : PBT
- ※ Dimensions in mm, [ ] = inches
- ※ Mounting torque : 1.2N·m max
- ※ Input and output terminal screw tightening torque
  - M4 1.6N·m max
  - M5 2.5N·m max
- ※ Please connect safety ground to FG terminal on the unit.

# PCA1500F

PC A 1500 F -5 -□

① ② ③ ④ ⑤ ⑥



RoHS



2MOPP



Example recommended EMI/EMC filter  
NAC-30-472



High voltage pulse noise type : NAP series  
Low leakage current type : NAM series  
Low profile type : EAC series

\*A higher current rating EMI/EMC filter may be recommended in view of the other devices that could be connected in parallel with the power supply.

- ① Series name
- ② Single output
- ③ Output wattage
- ④ Universal input
- ⑤ Output voltage
- ⑥ Optional \*6
- C : with Coating
- G : Low leakage current
- L : with PMBus interface
- F2 : Reverse air exhaust type
- P3 : Master-slave Operation
- W1 : Alarm function

For option details, refer to instruction manual 6.1.

\*Make sure necessary tests will be carried out on your end equipment with the power supply installed in accordance with any required EMC/EMI regulations.

MODEL		PCA1500F-5	PCA1500F-12	PCA1500F-15	PCA1500F-24	PCA1500F-32	PCA1500F-48
MAX OUTPUT WATTAGE[W]	ACIN 100V/230V	1500/1500	1500/1500	1500/1500	1560/1680	1504/1664	1536/1680
DC OUTPUT	ACIN 100V/230V	5V 300A/300A	12V 125A/125A	15V 100A/100A	24V 65A/70A	32V 47A/52A	48V 32A/35A

## SPECIFICATIONS

	MODEL	PCA1500F-5	PCA1500F-12	PCA1500F-15	PCA1500F-24	PCA1500F-32	PCA1500F-48	
INPUT	VOLTAGE	[VAC]	85 - 264 1 φ (Output derating is required at less than 95V. Refer to "Derating")					
	CURRENT[A]	ACIN 100V	18typ					
		ACIN 230V	7.8typ				8.5typ	
	FREQUENCY[Hz]		50/60 (45 - 66)					
	EFFICIENCY[%]	ACIN 100V	(Io=50%)	90typ	91typ	91typ	91typ	91typ
			(Io=100%)	88typ	90typ	90typ	91typ	91typ
		ACIN 230V	(Io=50%)	92typ	92typ	92typ	93typ	93typ
			(Io=100%)	91typ	92typ	92typ	93typ	93typ
	POWER FACTOR	ACIN 100V	0.98typ (Io=100%)					
		ACIN 230V	0.95typ (Io=100%)					
INRUSH CURRENT[A]	ACIN 100V*1	20/40 typ (Io=100%) (Primary inrush current / Secondary inrush current) (More than 10 sec. to re-start)						
	ACIN 230V*1	40/40 typ (Io=100%) (Primary inrush current / Secondary inrush current) (More than 10 sec. to re-start)						
LEAKAGE CURRENT[ma]		0.5max (ACIN 240V 60Hz, Io=100%, According to IEC60601-1)						
OUTPUT	VOLTAGE[V]	5	12	15	24	32	48	
	CURRENT[A]	ACIN 100V/230V	300/300	125/125	100/100	65/70	47/52	32/35
	LINE REGULATION[mV]		20max	48max	60max	96max	128max	192max
	LOAD REGULATION[mV]		40max	100max	120max	150max	150max	480max
	RIPPLE[mVp-p]	0 to +50°C *2*3	160max	240max	240max	240max	320max	480max
		-20 to 0°C *2	280max	320max	320max	320max	420max	640max
	RIPPLE NOISE[mVp-p]	0 to +50°C *2*3	240max	300max	300max	300max	400max	600max
		-20 to 0°C *2	320max	360max	360max	360max	480max	720max
	TEMPERATURE REGULATION[mV]	0 to +50°C *3	50max	120max	150max	240max	320max	480max
		-20 to +50°C *3	75max	180max	180max	290max	400max	600max
DRIFT[mV]	*4	20max	48max	60max	96max	128max	192max	
START-UP TIME[ms]		700typ (ACIN 100/230V Io=100%)						
HOLD-UP TIME[ms]		20typ (ACIN 230V Io=80%) / 16typ (ACIN 230V Io=100%)						
OUTPUT VOLTAGE ADJUSTMENT RANGE[V]		3.00 to 6.00	7.20 to 14.40	9.00 to 18.00	14.40 to 28.80	19.20 to 38.40	28.80 to 57.60	
OUTPUT VOLTAGE SETTING[V]		5.00 to 5.05	12.00 to 12.12	15.00 to 15.15	24.00 to 24.24	32.00 to 32.32	48.00 to 48.48	
PROTECTION CIRCUIT AND OTHERS	OVERCURRENT PROTECTION	Works over 105% of rating (Recovers automatically, Hiccup overcurrent)						
	OVERVOLTAGE PROTECTION[V]	6.25 to 7.00	15.00 to 16.80	18.75 to 21.00	30.00 to 33.60	40.00 to 44.80	60.00 to 67.20	
	REMOTE SENSING	Provided						
	REMOTE ON/OFF (RC)	Provided						
	DC_OK LAMP	LED (Blue)						
	ALARM LAMP	LED (Orange)						
COMMUNICATION FUNCTION	Provided (Extended UART)							
ISOLATION	INPUT-OUTPUT	AC4,000V 1minute, Cutoff current = 10mA, DC500V 50MΩ min (At Room Temperature) 2MOPP						
	INPUT-FG	AC2,000V 1minute, Cutoff current = 10mA, DC500V 50MΩ min (At Room Temperature) 1MOPP						
	OUTPUT-FG	AC500V 1minute, Cutoff current = 100mA, DC500V 50MΩ min (At Room Temperature)						
ENVIRONMENT	OPERATING TEMP., HUMIDITY AND ALTITUDE	AC500V 1minute, Cutoff current = 100mA, DC500V 50MΩ min (At Room Temperature)						
SAFETY AND NOISE REGULATIONS	AGENCY APPROVALS	UL62368-1, EN62368-1, C-UL (equivalent to CAN/CSA-C22.2 No.62368-1), ANSI/AAMI ES60601-1, EN60601-1 3rd, C-UL (equivalent to CAN/CSA-C22.2 No.60601-1), Complies with IEC60601-1-2 4th Ed.						
	CONDUCTED NOISE	Complies with FCC Part15 classA, VCCI-A, CISPR11-A, CISPR32-A, EN55011-A, EN55032-A						
	HARMONIC ATTENUATOR *5	Complies with IEC61000-3-2 (class A)						

## SPECIFICATIONS

OTHERS	CASE SIZE/WEIGHT	140×41×203mm [5.52×1.61×7.99 inches] (without terminal block and screw) (W×H×D) / 2.0kg max
	COOLING METHOD	Forced cooling (internal fan)

- \*1 The value is primary surge. The current of input surge to a built-in EMI/EMS Filter(0.2ms or less) is excluded.
- \*2 Measured by 20MHz oscilloscope or Ripple-Noise meter (equivalent to KEISOKU-GIKEN:RM103). Please refer to the instruction manual 1.2.
- \*3 5V, 12V, 15V output product, the maximum temperature of 40°C.
- \*4 Drift is the change in DC output for an eight hours period after a half-hour warm-up at 25°C.
- \*5 Please contact us about another class.
- \*6 The listed options may affect the published standard specifications. Please contact us for detailed product specifications and safety approvals.
- \* A sound may occur from power supply at pulse loading.

## Features

- Low profile (41mm, 1.61 inch = meet 1U height)
- Universal input 85 - 264VAC (Refer to “Derating”, when using at 85 - 95VAC)
- For medical electric equipment (ANSI/AAMI ES60601-1, EN60601-1 3rd, IEC60601-1-2 4th Ed.)
- Medical Isolation Grade 2MOPP
- With AUX output 12V 0.1A (Voltage adjustable range 5 - 12V)
- Constant current function
- Output voltage can be adjusted to near 0V (Refer to the item 2.6 on Instruction Manual.)
- With various alarms
- Parallel Operation / N+1 Parallel Redundancy Operation available
- Monitoring function and various setting values can be changed by communication (Refer to the item 2.11 on Instruction Manual.)
- Complies with SEMI F47 (Refer to the item 2.1 on Instruction Manual.)

## Block diagram

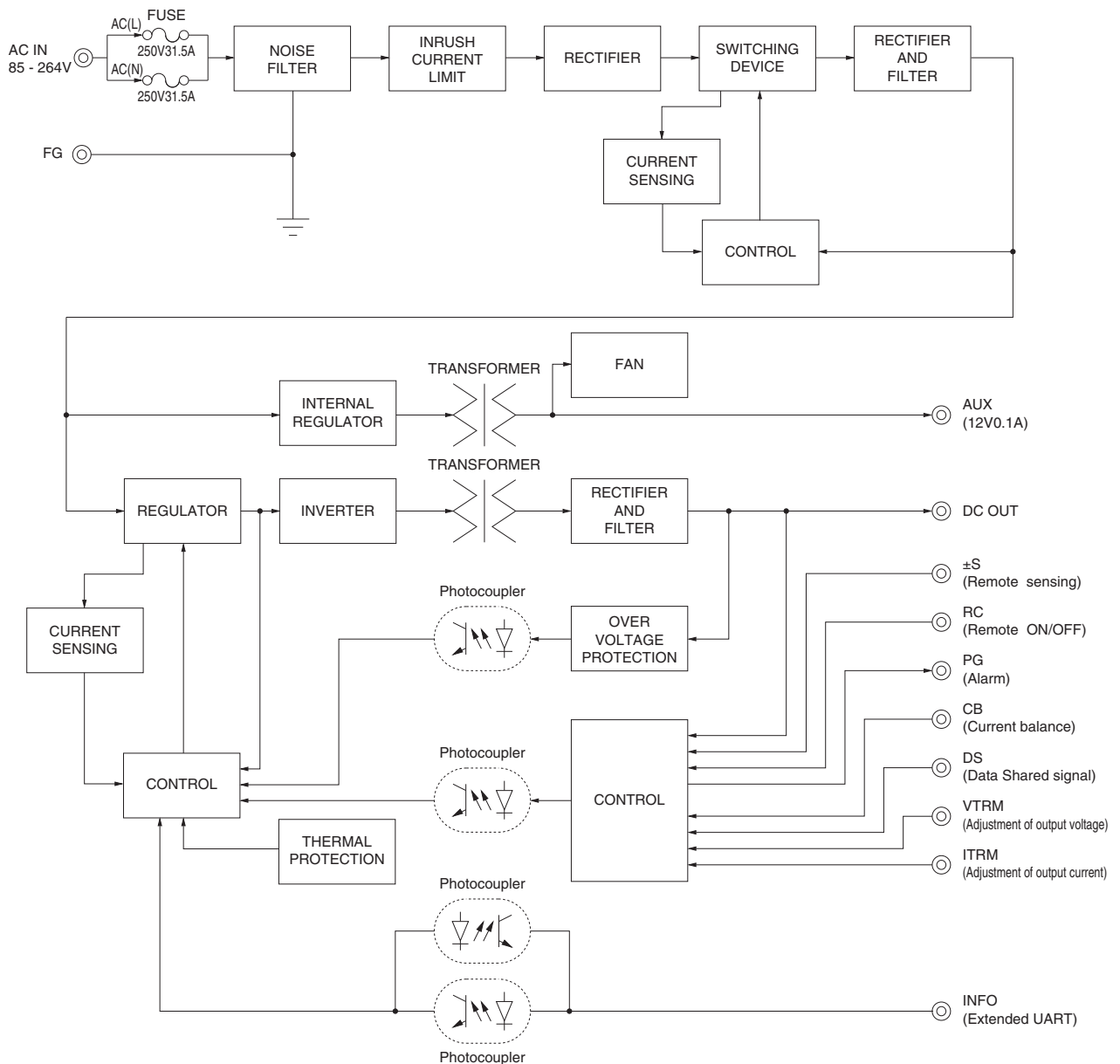

## External view

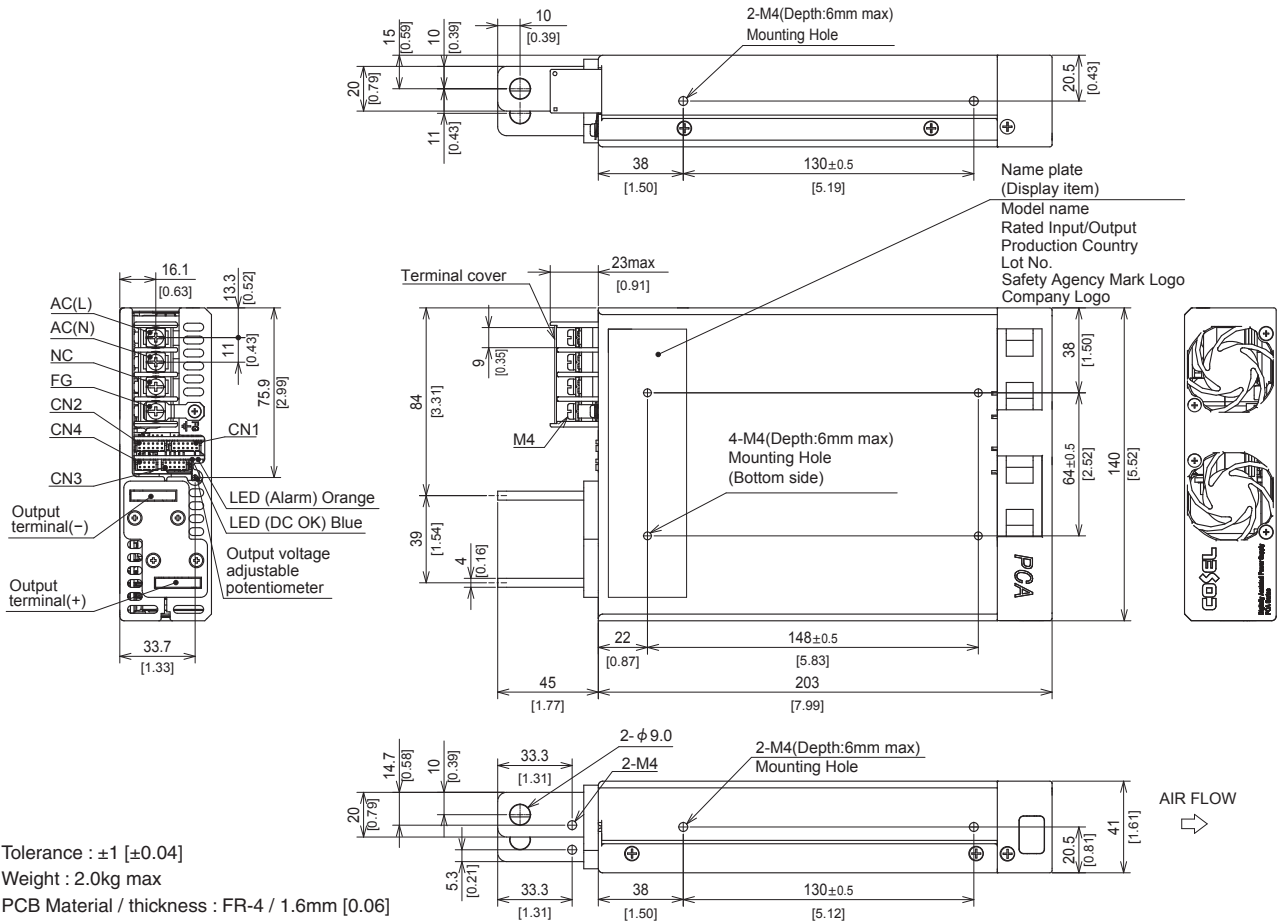

- ※ Tolerance :  $\pm 1$  [ $\pm 0.04$ ]
- ※ Weight : 2.0kg max
- ※ PCB Material / thickness : FR-4 / 1.6mm [0.06]
- ※ Chassis Material : Aluminum
- ※ Fan cover Material : PBT
- ※ Dimensions in mm, [ ] = inches
- ※ Mounting torque : 1.2N·m max
- ※ Input and output terminal screw tightening torque
  - M3 0.6N·m max
  - M4 1.6N·m max
- ※ Please connect safety ground to FG terminal on the unit.



## Terminal Blocks

### ●PCA300F, PCA600F

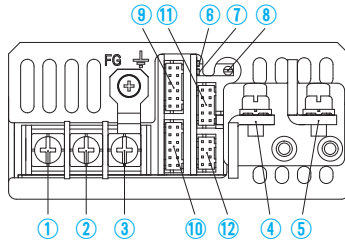

### ●PCA1000F

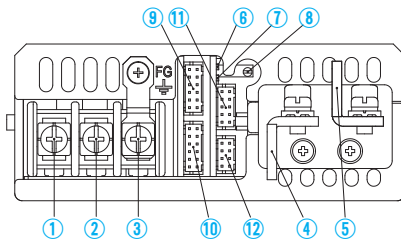

### ●PCA1500F

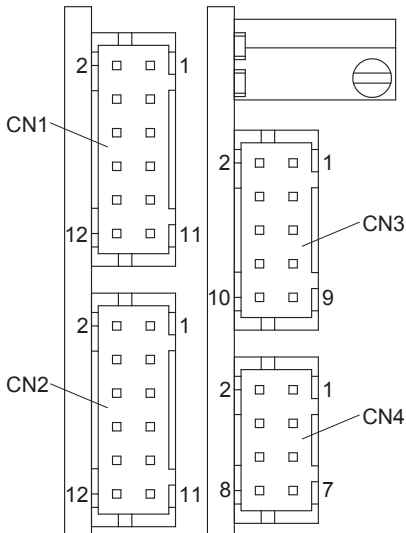
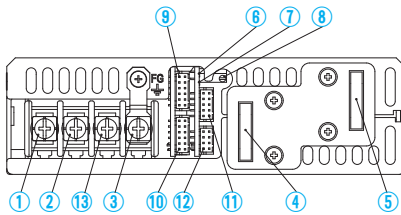

Connector pin numbers

- ①AC (L) } Input Terminals 85 - 264VAC 1 φ 45 - 66Hz
- ②AC (N) } (M4) 88 - 370VDC (Excluding PCA1000F PCA1500F)
- ③Frame ground (M4)
- ④-Output
- ⑤+Output
- ⑥LED for fault condition detection (ALARM) Color : Orange
- ⑦LED for output voltage confirmation (DC\_OK) Color : Blue
- ⑧Output voltage adjustable potentiometer
- ⑨CN1
- ⑩CN2
- ⑪CN3
- ⑫CN4
- ⑬N.C.

#### Pin Configuration and Functions of CN1, CN2

Pin No.	Function	Ground level	
1	+S	+Remote sensing	COM
2	N.C.	No connection	-
3	N.C.	No connection	-
4	-S	-Remote sensing	COM
5	VTRM	Adjustment of output voltage	COM
6	COM	Common ground (for signal)	COM
7	INFO	Extended UART signal	SGND
8	CB	Current Balance	COM
9	DS	Data Shared signal	SGND
10	SGND	Signal ground	SGND
11	RC2	Remote ON/OFF	RCG
12	RCG	Remote ON/OFF ground	RCG

\* Each terminal of CN1 and CN2 are connected inside the power supply.

#### Pin Configuration and Functions of CN3

Pin No.	Function	Ground level	
1	AUX	Auxiliary output	AUXG
2	AUXG	Auxiliary output ground	AUXG
3	RC1	Remote ON/OFF	AUXG
4	AUXG	Auxiliary output ground	AUXG
5	PG	Alarm	PGG
6	PGG	Alarm ground	PGG
7	ITRM	Adjustment of output current	COM
8	COM	Common ground (for signal)	COM
9	VTRM_EN	Enable Vtrm	COM
10	SLV_EN	Enable Slave mode *1	COM

#### Pin Configuration and Functions of CN4

Pin No.	Function	Ground level	
1	SDA	Serial data *2	SGND
2	SGND	Signal ground	SGND
3	SCL	Serial clock *2	SGND
4	SMBA	SMBAlert *2	SGND
5	ADDR0	Address bit 0	SGND
6	ADDR1	Address bit 1	SGND
7	ADDR2	Address bit 2	SGND
8	SGND	Signal ground	SGND

#### Matching connectors and terminals

Connector	Housing	Terminal	Mfr.
CN1 CN2	S12B-PHDS	PHDR-12VS	Reel : SPHD-002T-P0.5 Loose : BPHD-001T-P0.5 *3 BPHD-002T-P0.5 *3 J.S.T
CN3	S10B-PHDS	PHDR-10VS	
CN4	S8B-PHDS	PHDR-8VS	

\*1 For -P3 option.

\*2 For -I option.

\*3 The manufacturer prepares only the ratchet hand.

## Assembling and Installation Method

■ Please observe the mounting screw length in right figure to obtain enough isolation between screws and internal components.

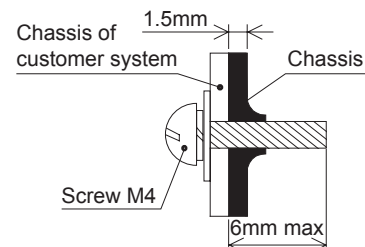

## Assembling and Installation Method

- Please do not block built-in fans and ventilation holes. When the power supply is mounted by screws, please consider its weight and set it in place. (Please see below.)
- Please avoid installing the power supply by only one narrow side like the Fig.(c).  
In that case, another narrow side or the wide side should be also used to install as shown in Fig.(d), (e), and (f).
- If power supplies are used in a dusty environment, it might cause a failure. Please consider taking such countermeasures as installing an air filter near the suction area of the system to prevent a failure.

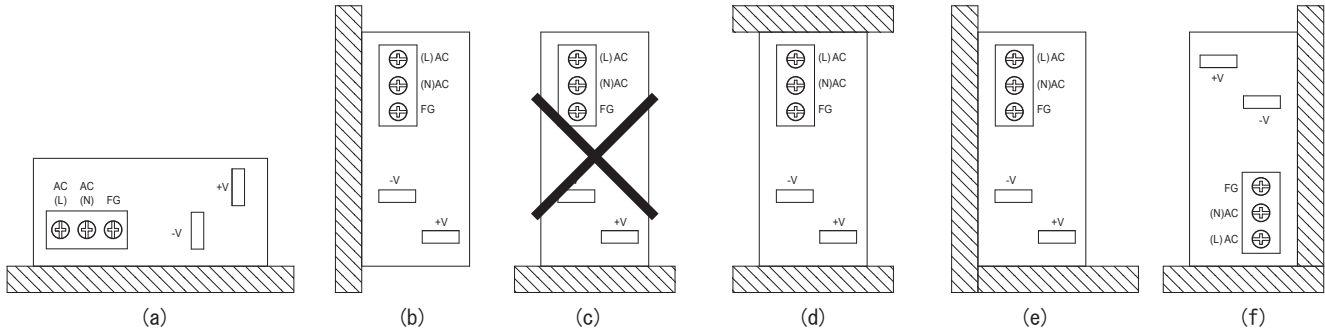

## Derating

### Input voltage Derating curve

#### ● PCA600F

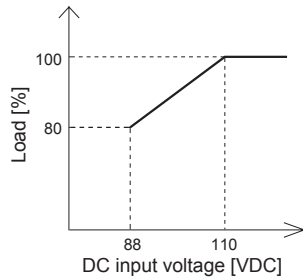
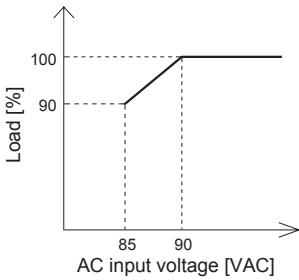

#### ● PCA1000F

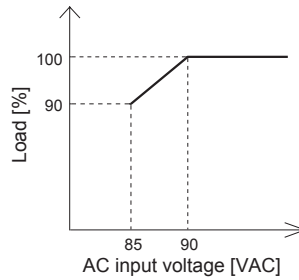

#### ● PCA1500F

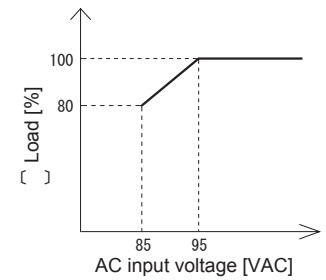

#### ● PCA300F-5

### Ambient Temperature Derating Curve

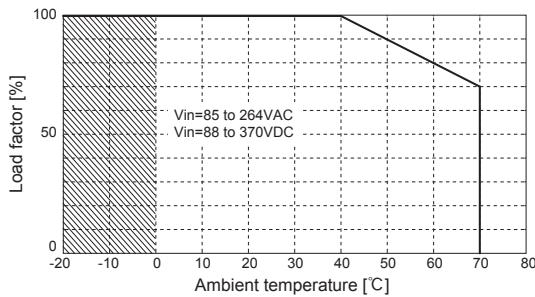

#### ● PCA300F-12, -15, -24, -32, -48

### Ambient Temperature Derating Curve

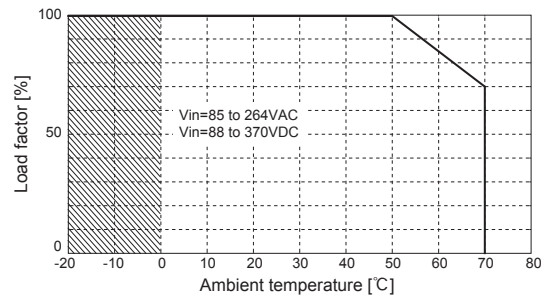

#### ● PCA600F-5

### Ambient Temperature Derating Curve

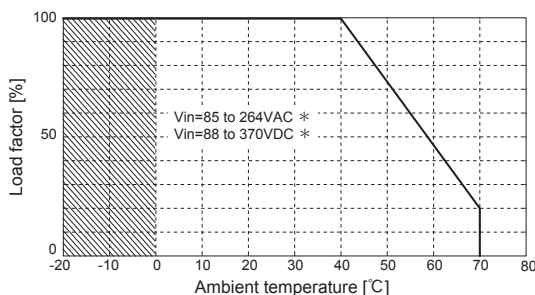

\*With derating due to input voltage

#### ● PCA600F-12, -15, -24, -32, -48

### Ambient Temperature Derating Curve

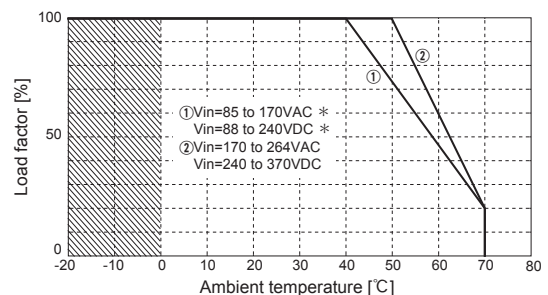

\*With derating due to input voltage

Derating

● PCA1000F-5, -12, -15  
Ambient Temperature Derating Curve

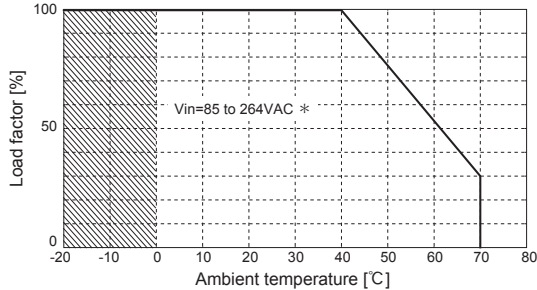

\*With derating due to input voltage

● PCA1000F-24, -32, -48  
Ambient Temperature Derating Curve

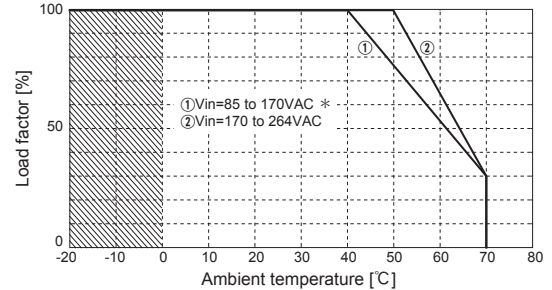

\*With derating due to input voltage

● PCA1500F-5,-12,-15  
Ambient Temperature Derating Curve

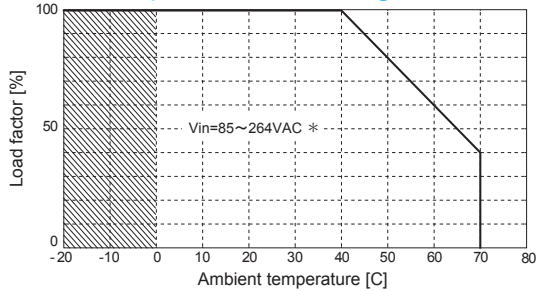

\*With derating due to input voltage

● PCA1500F-24,-32,-48  
Ambient Temperature Derating Curve

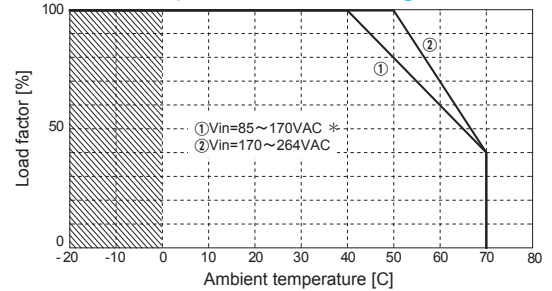

\*With derating due to input voltage

- Specifications for ripple and ripple noise are different in the hatched area.
- The ambient temperature is defined as the temperature of the air at air-intake side of the power supply.

Instruction Manual

◆ It is necessary to read the "Instruction Manual" and "Before using our product" before you use our product.

Instruction Manual <https://www.cosel.co.jp/redirect/catalog/en/PCA/>  
 Before using our product <https://en.cosel.co.jp/technical/caution/index.html>

PCA



NOTICE



Basic Characteristics Data

Model	Circuit method	Switching frequency [kHz]	Input current [A]	Rated input fuse	Inrush current protection circuit	PCB/Pattern			Series/Parallel operation availability	
						Material	Single sided	Double sided	Series operation	Parallel operation
PCA300F	Active filter	15 - 400	3.8	250V 10A	Relay	FR-4	-	Yes	Yes	Yes
	Buck converter	88								
	Full - bridge converter	44								
PCA600F	Active filter	15 - 400	7.3	250V 16A	Relay	FR-4	-	Yes	Yes	Yes
	Buck converter	88								
	Full - bridge converter	44								
PCA1000F	Active filter	15 - 400	12.0	250V 20A	Relay	FR-4	-	Yes	Yes	Yes
	Buck converter	88								
	Full - bridge converter	44								
PCA1500F	Active filter	15 - 400	18.0	250V 31.5A	Relay	FR-4	-	Yes	Yes	Yes
	Buck converter	88								
	Full - bridge converter	44								

\* The value of input current is at ACIN 100VAC and rated load.