



Human .
Design .
Technology .



HMI/IPC Control Enclosures Suspension Arm Systems

Perfect design for machine building. Sophisticated HMI/IPC control enclosures and suspension arm systems that enhance your machine. The perfect symbiosis of design, flexibility and technical sophistication.

profiPANEL / multiPANEL / profiPLUS 5

Designer HMI/IPC control enclosures and suspension arm system



profiPANEL PPD 210
(Combi 150/60)

multiPANEL MPD 70



taraSMART

2 HMI/control enclosure series plus 3 suspension arm system models – the perfect symbiosis of design and technology.

Design is playing an increasingly important role in machine construction. Our sophisticated product lines enable us to provide efficient solutions for modern machine construction, from both a technical and design perspective.

profiPANEL Standard – the economical version of the HMI/control enclosure series, 90 mm deep. Four standard sizes are available at short notice.

From page 6

profiPANEL – The modern HMI/control enclosure series available in 9 depths (from 60-300 mm). Attractive design featuring anodised aluminium profiles. Manufactured to measure. From page 8

multiPANEL – the premium HMI/control enclosure series available in 2 depths (70 and 85 mm). Exclusive design featuring powder coated aluminium profiles with attractive stainless steel inlays. Manufactured to measure.

From page 15

profiPLUS 50/70 – the designer suspension arm system, combining design and technology in perfect symbiosis. Its appearance blends perfectly with the design of modern machinery. From page 28

taraSMART – the evolution of a classic: A modern, economical suspension arm system for modern machine construction. The perfect symbiosis of technical design and technical sophistication. From page 50

profiPANEL / profiPANEL Standard

The economical HMI/control enclosure



profiPANEL PPD 120
with a built-in socket



profiPANEL PPD 150
(Combi 90/60) with desk 60



Human. Design. Technology.

"The aim of the development of profiPANEL was to create an economical and cost-efficient control enclosure with an attractive design, offering complete flexibility for every form of machine construction as standard."

Matthias Rose

The key product features of profiPANEL Standard at a glance:

- Four standard sizes with locks and hinges (on the longer side) with a depth of 90 mm; suitable for panel PCs up to 21"
- Economical alternative due to standardisation
- Shorter delivery times as components are held in stock
- Customised machining of the front plate
- Ingress protection to IP 65

The key product features of profiPANEL at a glance:

- Profile enclosure – manufactured to measure
- Nine depths consisting of four basic profiles
- Minimalist design for modern machinery
- Customised machining of the front plate
- Direct access through doors with locks and hinges (on the longer side as standard)
- High-quality material: anodised extruded aluminium profiles
- Ingress protection to IP 65

Use our practical multiPANEL configurator
at rolec.com



profiPANEL Standard

The economical system in standard sizes with a customised front plate

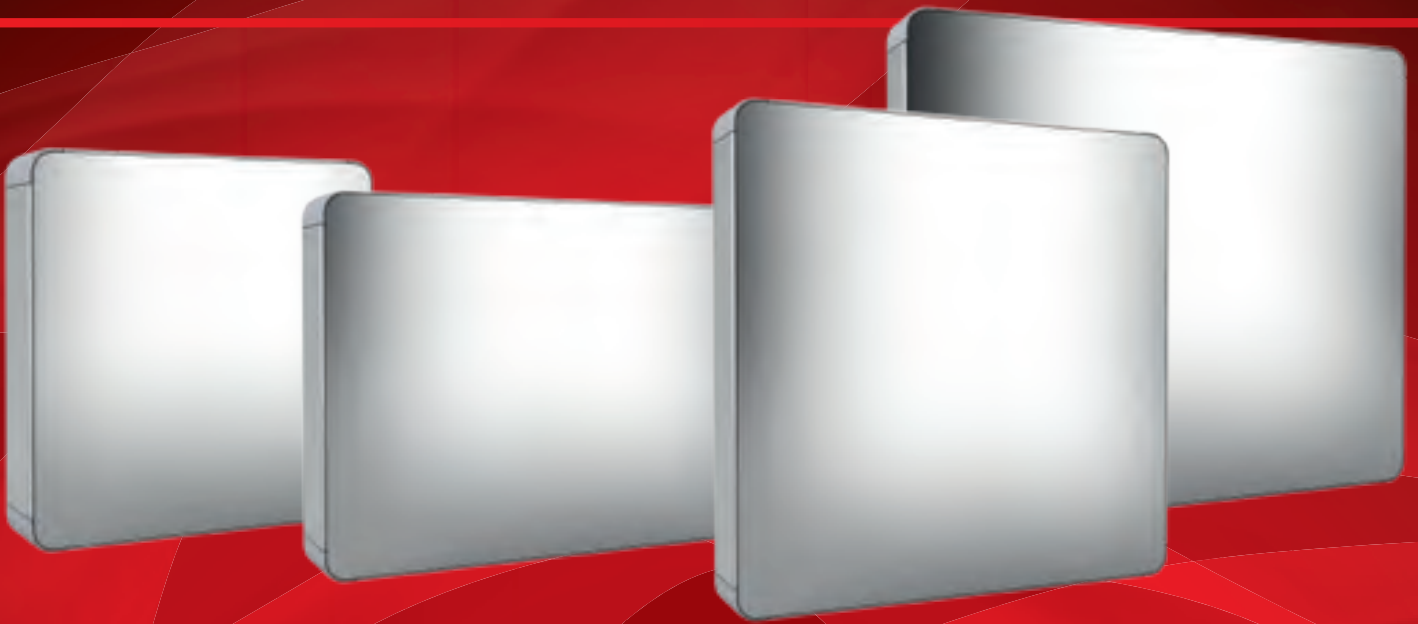

The 90 mm cost-effective standard basic profile.

For everyone in a rush, who requires only a small batch size or who does not need millimetre-precise dimensions: We have developed the "profiPANEL Standard" for them. Four standard sizes from a 90 mm basic profile with an individually configurable front plate into which every panel PC and additional buttons or switches can be incorporated. The rear wall features locks and hinges on the longer sides.

The benefits of "profiPANEL Standard" at a glance:

- Four standard sizes to fit panel PCs up to 21"
- Economical alternative due to standardisation
- Shorter delivery times as components are held in stock
- Customised machining of the front plate
- Coloured corners in traffic red, traffic blue or jet black without a surcharge (standard: light grey)
- Ingress protection to IP 65

profiPANEL Standard 10"-12"

331.090.AAA



For internal mounting of 10 to 12 inches*
Assignment space:
355 x 355 mm
External dimensions:
400 x 400 mm
Rear wall with locks and hinges

profiPANEL Standard 12"-15"

331.090.BBB



For internal mounting of 12 to 15 inches*
Assignment space:
355 x 475 mm
External dimensions:
400 x 520 mm
Rear wall with locks and hinges

* **Note:** The internal mounting sizes for panel PCs are intended only as a guideline figure as the manufacturer's air circulation values also n

front plate that you can configure yourself

4 simple steps to a perfectly coordinated, economical control enclosure:



1: Choose an enclosure size based on the planned internal mountings*.

2: Specify the desired front plate processing.

3: Define the position of the suspension arm mounting.

4: Select the optional profile handle(s). At the side or below the enclosure is possible.

profiPANEL Standard 15"-17"



331.090.CCC

For internal mounting of 15 to 17 inches*
Assignment space:
475 x 475 mm
External dimensions:
520 x 520 mm
Rear wall with locks and hinges

profiPANEL Standard 17"-21"



331.090.DDD

For internal mounting of 17 to 21 inches*
Assignment space:
475 x 555 mm
External dimensions:
520 x 600 mm
Rear wall with locks and hinges

eed to be taken into consideration.

profiPANEL

The economical HMI and control enclosure – Enclosure dep

Four basic profiles, nine depths.

Thanks to the option of combining all basic profile depths, profiPANEL enables a total of nine mounting depths to be realised. The connection of a 60 or 90 mm deep desk (see next page) also offers additional options for extended internal mountings. Thanks to this wide range of depths, profiPANEL therefore enables almost every conceivable configuration for the internal mounting of components to be realised. The front of the profiPANEL system enclosure is manufactured to measure. The design facilitates almost seamless, flush installation of the front plate, which is permanently connected to the enclosure. Appropriate cut-outs for a display, switches and more are included in the service provided by ROLEC and are produced ex-works to meet customer specifications. The profiles can also be machined on request (e.g. USB, buttons, etc.).



PPD 120 Basic

The 120 mm basic profile is manufactured as standard with a flush door with locks and exterior hinges (as standard on the longer side). A fully bolted rear wall is also alternatively available.



PPD 120 (Combi 60/60)

The 120 mm deep enclosure consists of a combination of two 60 mm basic profiles. It features locks and exterior hinges.



PPD 60 Basic

The 60 mm basic profile is manufactured as standard with a flush door with locks and exterior hinges (as standard on the longer side). A fully bolted rear wall is also alternatively available.



PPD 150 Basic

The 150 mm deep basic profile is manufactured as standard with a flush door with locks and exterior hinges (as standard on the longer side). A fully bolted rear wall is also alternatively available.



PPD 90 Basic

The 90 mm basic profile is manufactured as standard with a flush door with locks and exterior hinges (as standard on the longer side). A fully bolted rear wall is also alternatively available.



PPD 150 (Combi 90/60)

The 150 mm deep enclosure consists of the combination of a 90 mm and a 60 mm basic profile. It features locks and exterior hinges.

**PPD 180 (Combi 90/90)**

The 180 mm deep enclosure consists of the combination of two 90 mm basic profiles. It features locks and exterior hinges.

**PPD 240 (Combi 120/120)**

The 240 mm deep enclosure consists of the combination of two 120 mm basic profiles. It features locks and exterior hinges.

**PPD 180 (Combi 120/60)**

The 180 mm deep enclosure consists of the combination of a 120 mm and a 60 mm basic profile. It features locks and exterior hinges.

**PPD 240 (Combi 150/90)**

The 240 mm deep enclosure consists of the combination of a 150 mm and a 90 mm basic profile. It features locks and exterior hinges.

**PPD 210 (Combi 120/90)**

The 210 mm deep enclosure consists of the combination of a 120 mm and a 90 mm basic profile. It features locks and exterior hinges.

**PPD 270 (Combi 150/120)**

The 270 mm deep enclosure consists of a combination of a 150 mm and a 120 mm basic profile. It features locks and exterior hinges.

**PPD 210 (Combi 150/60)**

The 210 mm deep enclosure consists of the combination of a 150 mm and a 60 mm basic profile. It features locks and exterior hinges.

**PPD 300 (Combi 150/150)**

The 300 mm deep enclosure consists of a combination of two 150 mm basic profiles. It features locks and exterior hinges.

profiPANEL

The economical HMI and control enclosure – Desk connecti



When you simply need more.

Sometimes specific applications need specific solutions. A desk is a clever solution when there's not enough space in the control enclosure or you need additional buttons. The profiPANEL series therefore includes two desk models, 60 and 90 mm deep (D), for internal mounting. The desk connection offers plenty of space (42 x 26 mm) for routing HDMI or DVI cables or network plugs.

The width (W) of the desk is automatically adapted to that of the control enclosure. The desk is 200 mm high (H) ex works. Non-standard dimensions are available on request. The rear wall of the desk is bolted on as standard.

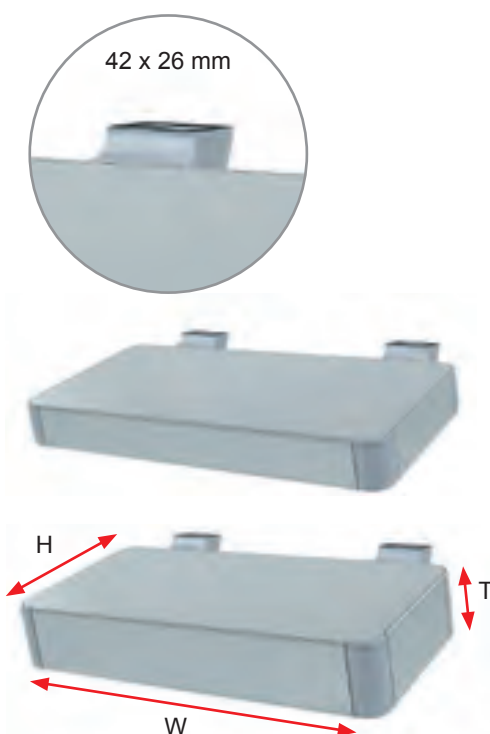

The 60 and 90 mm desk versions are each fastened to the basic profile of the control enclosure with two desk connections. Drill holes are made in the factory for fastening and for cable routing.

profiPANEL

The economical HMI and control enclosure – Accessories



Everything under control with coordinated accessories.

With a 60 mm enclosure depth, profiPANEL is the ideal HMI/control enclosure for operators. An ergonomically designed profile handle system is available for even more convenient handling, particularly with the deeper profile versions.

Accessories also include a 450 mm wide latching keyboard holder, which can be enhanced and/or extended by an additional mouse holder.



Practical: The 450 mm wide, latching keyboard holder and the matching mouse holder.



The keyboard holder can be easily adjusted. For optimum alignment of the keyboard and mouse holder.



Left: Wall Pivot Mount S
Rechts: Wall Pivot Mount L

The Wall Pivot Mount with three options.

The practical Wall Pivot Mount (S or L - depends on the enclosure) has adequate space (Ø 27 mm) for routing cables. It can be fixed, has a stop limit parallel to the wall and/or machine and can be fastened on the left or right side. It can also be used as a desk version. The maximum load-bearing capacity of the Wall Pivot Mount is 20 kg.



Design, technology, feel – the profiPANEL handle system:

The designer profile handle system for profiPANEL control enclosures has been specially developed to establish harmony with the enclosure design and the ROLEC suspension arm systems. The profile handles are concave and therefore ergonomically shaped. For a perfect grip.

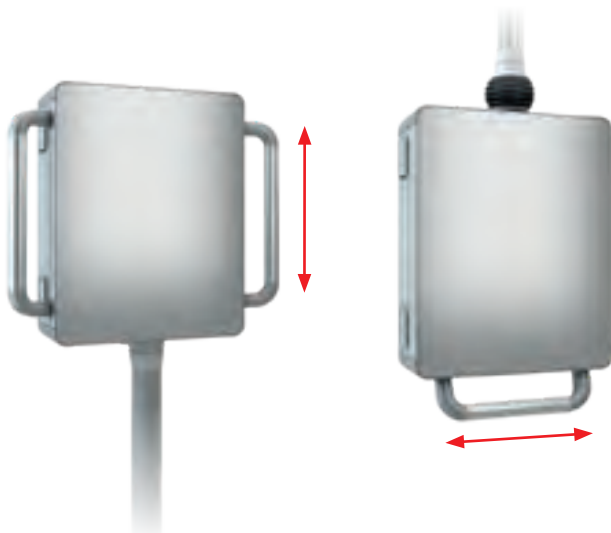

- For mounting on the side, under the enclosure or on the front of the desk
- Ergonomic shape – for a perfect feel
- Variable length (manufactured to measure)
- Coating: corner pieces, similar to RAL 7035 light grey
Profile: Anodised aluminium

profiPANEL

Alternative corner covers



Would you like a bit more colour?

As standard, the profiPANEL corner covers are delivered in RAL 7035 (light grey). A real eye-catcher in combination with the narrow sealing edge in RAL 7016 (anthracite grey). For everyone who wants things to be a bit more colourful, alterna-

tively, the corner covers for all enclosure depths are also available in the colours RAL 3020 (traffic red), 5017 (traffic blue) and 9005 (jet black) at the same price. For this, simply tick the desired colour in the enquiry form.



RAL 7035

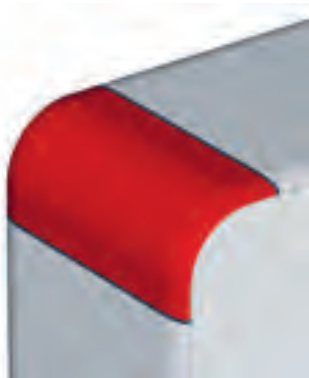

RAL 3020



RAL 5017

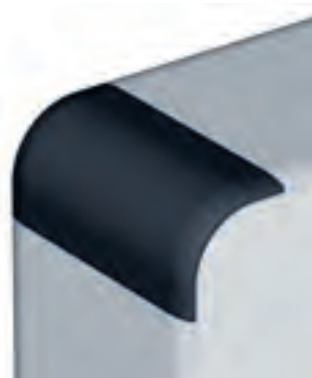

RAL 9005

profiPANEL

Product overview



Human. Design. Technology.

Type	Art. no.	Depth	Rear wall with hinge	Double-bit fastener	Bolted rear wall	Profile handle	Keyboard/mouse holder	Desk 60	Desk 90	Wall Pivot Mount S	Wall Pivot Mount L	Coloured corners
*PPD 60 Basic	330.060.001	60	•	•	o	o	o	o		o		o
*PPD 90 Basic	330.090.001	90	•	•	o	o	o	o	o	o		o
PPD 120 Basic	330.120.001	120	•	•	o	o	o	o	o	o		o
*PPD 120 (Combi 60/60)	332.120.001	120		•		o	o	o				o
*PPD 150 Basic	330.150.001	150	•	•	o	o	o	o	o	o		o
*PPD 150 (Combi 90/60)	332.150.001	150		•		o	o	o	o		o	o
*PPD 180 (Combi 90/90)	332.180.001	180		•		o	o	o	o			o
PPD 180 (Combi 120/60)	332.180.004	180		•		o	o	o	o		o	o
PPD 210 (Combi 120/90)	332.210.004	210		•		o	o	o	o			o
*PPD 210 (Combi 150/60)	332.210.001	210		•		o	o	o	o		o	o
PPD 240 (Combi 120/120)	332.240.004	240		•		o	o	o	o			o
*PPD 240 (Combi 150/90)	332.240.001	240		•		o	o	o	o			o
PPD 270 (Combi 150/120)	332.270.001	270		•		o	o	o	o			o
*PPD 300 (Combi 150/150)	332.300.001	300		•		o	o	o	o			o

• Standard o Optionally available

The external dimensions of profiPANEL measure a minimum of 150x150 mm and a maximum of 800x800 mm. When ordering, it is possible to specify the front plate width and height, the installation size of the panel PC (from 7") or the exterior dimensions of the enclosure. Please also specify any desired accessories with your enquiry/order. Use our enquiry form at rolec.com in the download area of the profiPANEL product group.

Technical data

Enclosure/desk coating

Anodised silver

Front plate/desk coating

Anodised silver

Rear wall/desk coating

Anodised silver

Corner cover

Thermoplast, RAL 7035

Closure

Rear wall with locks and hinges

Ingress protection

Up to IP65 / EN 60529

Approvals

*UL

OPTIONAL:

Coloured corner covers
similar to RAL 3020, 5017 or 9005

Profile handle

Extruded aluminium profile with plastic connection, similar to RAL 7035

Keyboard/mouse holder

Aluminium, powder coating, RAL 7035, light grey

Wall Pivot Mount

Aluminium, powder coating, RAL 7035, light grey

multiPANEL

Premium designer command enclosure – perfect for the instal



multiPANEL 70



"The aim with the development of multiPANEL was to create a high-quality enclosure with an attractive design, offering the flexibility of incorporating all modern control technology configurations."

Matthias Rose

The key product features of multiPANEL at a glance:

- Minimalist design for modern machinery
- Profile enclosure – manufactured to measure
- Two enclosure depths: 70 and 85 mm
- Incl. machined front plate
- Three rear wall versions
- High quality materials: Extruded aluminium profiles, decorative inlays in brushed stainless steel
- Enclosures available in every RAL colour
- Customer-specific machining
- Ingress protection to IP 65

multiPANEL

Premium designer command enclosure – perfect for the ins



multiPANEL 85
with keyboard and
mouse holder and
taraSMART panel
coupling profile



**multiPANEL 70
with handle and
profiPLUS 50 panel
coupling N**



**multiPANEL 70
with Wall Pivot Mount**

The new flexibility.

Design is playing an increasingly important role in machine construction. The multiPANEL premium designer command enclosures produced from aluminium profiles and brushed stainless steel inlays offer the combination of technical finesse and maximum flexibility, in conjunction with a highly advanced and attractive design for modern machines. Thanks to the profile technology, multiPANEL can be manufactured to measure, according to the customer's required width and height and serves for the full surface installation of a front plate. The two enclosure depths of 70 and 85 mm offer the maximum flexibility for every type of internal mounting.

multiPANEL

Premium designer command enclosure – front plate

Finished aluminium front plate for your internal mounting.

As previously described, the multiPANEL system offers the option of integrating every conceivable application. An aluminium front plate is inserted into the front of the multiPANEL at the factory. Almost borderless, with flush installation and permanently connected to the enclosure. Suitable cut-outs for an

HMI/panel PC, switches, buttons and other components are of course included in the service provided by ROLEC and are manufactured in our production facility in accordance with customer specifications.



**multiPANEL 70 with
machined aluminium
front plate.**

Economical, custom-fit and ready for installation: The front plate is permanently connected to the enclosure body.

It is fully mounted in the factory and delivered including the customer-specific machining.

Full service.



multiPANEL

Premium designer command enclosure – rear wall variants

Two enclosure depths: 70 and 85 mm – as required.

The rear wall is optionally available in three flush-fitting variants both with the flatter multiPANEL version with 70 mm as well as with the version with a depth of 85 mm: a bolted rear wall, a bolted door with hinges or a door with double-bit fasteners and hinges.

Internal mountings can naturally also be installed on the inside of the rear wall. For this purpose, stays are factory-fitted inside the door on request by the customer, in preparation for

the technical installation. The profiles can also be machined on request (e.g. for USB, switches, etc.). The multiPANEL control enclosure can be fastened hanging and upright on a suspension arm system. Ideally suited for this is a panel coupling from the profiPLUS 50 or taraSMART suspension arm systems.

The multiPANEL with bolted rear wall variant is also particularly well suited for the rear-side mounting of profiPLUS 50 and 70 with a desk coupling.





multiPANEL with bolted rear wall.

The bolted version in addition to the upright or hanging fastening also facilitates the option of the installation on a suspension arm (e.g. profiPLUS 50/70) by means of a desk coupling.



multiPANEL with bolted door.

The bolted door is equipped with hinges and facilitates easy opening without the complete removal of the rear wall.



multiPANEL with locks and hinges.

Equipped with hinges and double-bit fasteners. For quick opening and closing as required.

multiPANEL

Premium designer command enclosure – handles and hold



Design, technology, feel – the multiPANEL profile handle system:

The designer profile handle system for multiPANEL control enclosures has been specially developed to establish harmony with the enclosure design and the profiPLUS suspension arm system. The profile handles are concave and therefore ergonomically shaped. For a perfect grip.

- For mounting on the side or under the enclosure
- Ergonomic shape – for a perfect feel
- Variable length (manufactured to measure)
- Coating: Corner pieces similar to RAL 9005 jet black
Profile: Silver anodised aluminium



Perfect hold – with the ergonomic handle.

The ergonomic handle is particularly suitable for multiPANEL enclosures hanging on the suspension arm system. On request, the stainless steel inlay can be optionally printed with your logo or that of your customers.

- Attached beneath the enclosure as a single handle
- Ergonomic shape – for a perfect feel
- Coating: RAL 9005, jet black
Inlay: Brushed stainless steel

multiPANEL

Premium designer command enclosure – keyboard and mouse



For anyone who needs to get at the buttons.

The accessories provide a degree of convenience. Three keyboard holders and a mouse holder, which can be combined with the two large keyboard holders. A 380 mm wide version is available for smaller keyboards and a 450 mm wide one for standard keyboards. The latter is available in a rigid and

a latching version, which is ideal if your suspension system is equipped with a tilting coupling. In this way it is possible to counteract the angled setting of the monitor so that the keyboard also maintains an optimum position when the enclosure is tilted.



380mm wide, latching keyboard holder,
450mm wide, latching keyboard holder,
450mm wide, rigid keyboard holder,
Mouse holder – fits with both 450 mm holders.



The keyboard holder can be easily adjusted. For optimum alignment of the keyboard and mouse holder.

Colour comes into play here.

For a further customised look, the body can be powder coated in any chosen RAL colour. This lends the enclosure a completely individual appearance that matches the colour design of your machine.

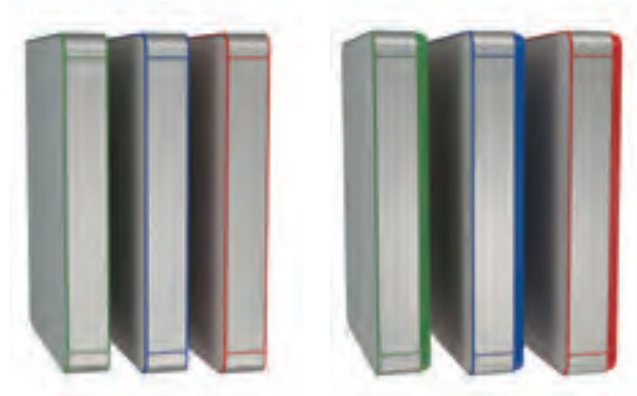

multiPANEL 70

	Type	Art. no.	Depth	Rear wall with hinge	Double-bit fastener	Handle/ Profile handle	Keyboard/ mouse holder	Wall Pivot Mount
	*MPD 7000 – bolted rear wall	320.000.001	70			o	o	o
	*MPD 7011 – bolted door	320.110.001	70	•		o	o	o
	MPD 7012 – door with lock and hinge	320.112.001	70	•	•	o	o	o

multiPANEL 85

	Type	Art. no.	Depth	Rear wall with hinge	Double-bit fastener	Handle/ Profile handle	Keyboard/ mouse holder	Wall Pivot Mount
	MPD 8500 – bolted rear wall	320.850.001	85			o	o	o
	MPD 8511 – bolted door	320.851.001	85	•		o	o	o
	MPD 8512 – door with lock and hinge	320.852.001	85	•	•	o	o	o

• Standard o Optionally available

The external dimensions of multiPANEL measure a minimum of 150x150 mm and a maximum of 800x800 mm. When ordering, it is possible to specify the front plate width and height, the installation size of the panel PC (from 7") or the exterior dimensions of the enclosure. Please also specify any desired accessories with your enquiry/order. Use our enquiry form at rolec.com in the download area of the multiPANEL product group.

Technical data

Enclosure coating
Powder coating, RAL 9005
Jet black, fine structure

Front plate coating
Anodised silver

Rear wall coating
Powder coating, RAL 9005
Jet black, fine structure

Decorative inlay coating
Stainless steel inlay V2A

Ingress protection
Up to IP65 / EN 60529

Approvals:
*UL

OPTIONAL:

Coating
Special colours

Handle
Thermoplast with
stainless steel inlay V2A

Profile handle
Extruded aluminium profile
with plastic connection

Keyboard/ mouse holder
Aluminium, powder coating,
RAL 9005 jet black,
fine structure

Wall Pivot Mount
Aluminium, powder coating,
RAL 9005 jet black,
fine structure

profiPLUS 50 and 70

The designer suspension arm system – the perfect addition to



The key product features of profiPLUS at a glance:

- Numerous system components, highly versatile
- Suitable for routing connectors such as HDMI, DVI or network adapters
- Many couplings with a pre-fitted support profile as standard
- Simple height adjustment with a patented "single screw adjustment"
- Comprehensive equipotential bonding
- Integrated cable protection in all system parts
- Matching adapters for Siemens, Beckhoff, B&R and other panel manufacturers
- Accessories: Signal light adapters for joint and elbow
- Ingress protection IP54

Use our practical suspension arm configurator at rolec.com

profiPLUS

The designer suspension arm system – the perfect addition to

An all-rounder for modern machines.

Suspension systems for enclosures and devices are always in view. Their appearance should harmonise with the design of modern machines. The technology must enable time-saving assembly with internal cable routing. In addition, profiPLUS has comprehensive equipotential bonding and practical rotation limitation.

For the pivoting elements of our profiPLUS suspension system we simply took the round, rotating earth as a template and realised a stable, diverse and aesthetically pleasing joint as the centre point. A complete suspension arm system with numerous intelligent components was developed around this round centre point. Naturally with adaptation options for panel PCs from leading manufacturers.





Smallest fastening dimensions – also for attaching to system profiles.

In order to also connect the profiPLUS 50 to small mounting surfaces and machines in an aesthetically elegant manner, we have developed the smart joint as a complement to the existing series. The simplest way of fastening is the direct attachment of the joint to the machine body with our standard drilling pattern. You can optionally receive a small adapter plate for fastening to structural machine profiles, e.g. from ITEM, Bosch, or similar. This matches with the shape of the joint. An individually tailored universal adapter plate is available with your desired drilling pattern for larger drilling patterns.

The advantages at a glance:

- Smallest fastening dimensions possible (from 33 x 44 mm)
- Variable adapter plates available for accepting any existing drilling pattern
- Perfect harmony of system components and adaptation to your machine's mounting surface

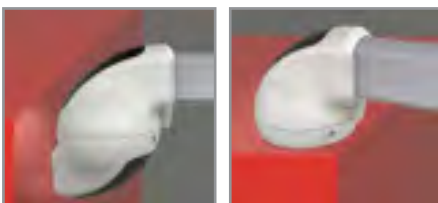

The smart joints can be fastened directly to the machine's body. Thanks to the ROLEC standard drilling pattern, a minimal fastening surface is required.

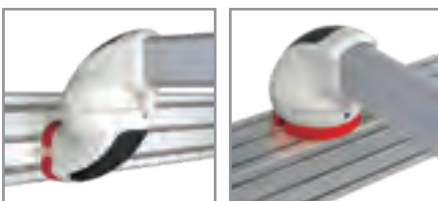

Using an additional adapter plate, the smart joints can be perfectly fastened to structural machine profiles from e.g. ITEM or Bosch.



A universal adapter plate with your desired drilling pattern is available for adapting an existing drilling pattern for both joints.

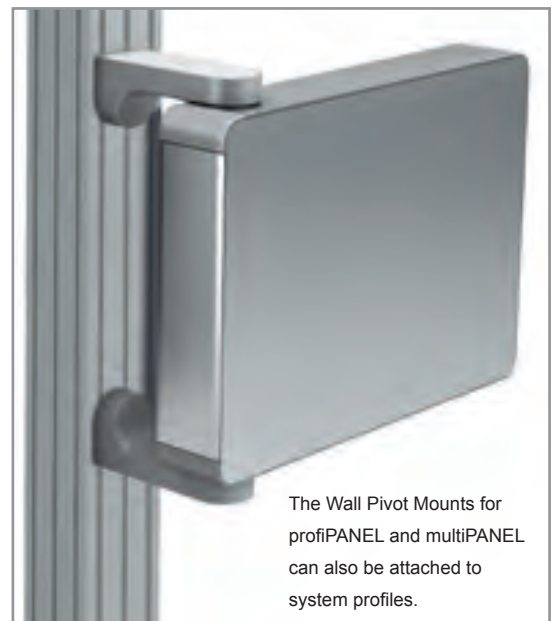

The Wall Pivot Mounts for profiPANEL and multiPANEL can also be attached to system profiles.

profiPLUS 50 and 70

The designer suspension arm system – examples of the system



Large or larger?

profiPLUS 50 is already an impressive sight. With extensive space for routing cables such as HDMI, DVI or network adapters. profiPLUS 70 offers even more room for further control lines. At the same time, the system's bearing strength increases significantly.

On request, the profiPLUS components are also available powder coated in any requested RAL colour in order to achieve even greater harmony with modern machinery.

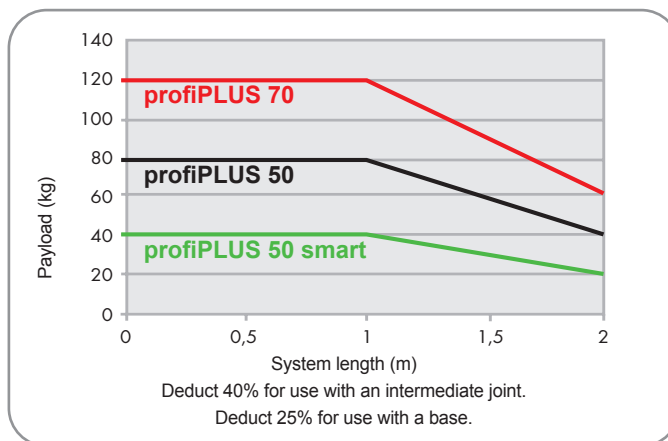

Preparation for
Conta-Clip
KDS-FB1

Preparation for
Conta-Clip
KDS-FB2

Preparation for
Conta-Clip
KDS-FB3

Preparation for
Conta-Clip
KDS-FB4

Profile preparation for cable outlet.

For everyone who has to lay the cables above the floor, we offer the option of preparing ready to use openings and fastening points for e.g. Conta-Clip cable entry points in the profiPLUS profile.

Thanks to its system diversity, profiPLUS offers a whole host of combination options for individual suspension arm configuration. The example variants presented here serve as orientation aids and examples of the diversity.

ROLEC's team will be happy to advise you on the configuration of a suspension arm tailored specifically to your requirements.

- 1 Panel coupling N (N = tilting)
incl. support profile, length is variable
- 2 Smart wall joint
- 3 Socket joint
- 4 Intermediate joint
- 5 Elbow

- 6 Base
- 7 Coupling / panel coupling incl.
support profile, length is variable
- 8 Wall joint
- 9 Elbow panel coupling N
- 10 Mobile base

- 11 Elbow coupling 50/48,
rotatable through 300°
- T Support profile,
length is variable
- R Round tube ø48,
length is variable

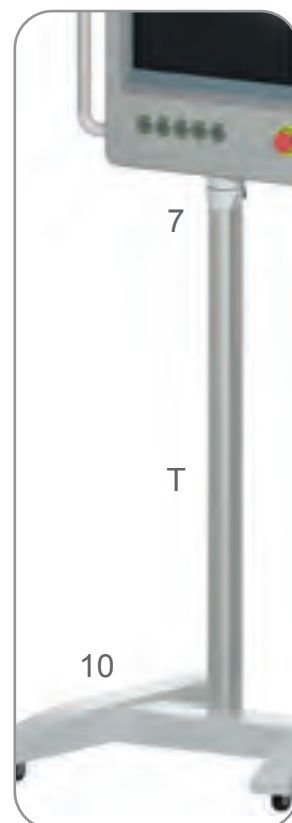
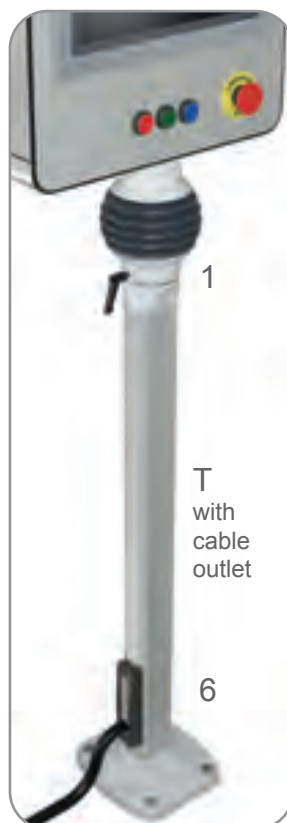

profiPLUS 50 and 70

The designer suspension arm system – well-thought out in e



Patented solution for rapid set-up and maximum benefits.

- Suitable adapters for connecting panels from leading manufacturers such as Siemens, Beckhoff and B&R
- Connection to existing, autonomous HMI panels possible
- Easy adjustment thanks to the patented "single screw adjustment"
- Quick assembly of the individual components



Well conceived standards offer many advantages - entirely without added costs.



Optional equipment items available as required.

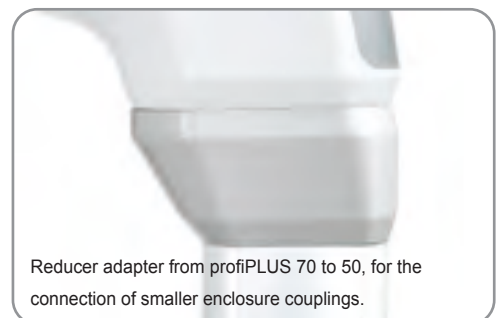

profiPLUS 50

The designer suspension arm system – connection/compatib

SIEMENS adapter
142.024.000



The ROLEC Siemens adapter is simply bolted between the ROLEC coupling and the Siemens base adapter or round tube adapter. This is suitable for the following Siemens Pro panels: **Comfort panels: KTPxxxx, TPxxxx, KPxxxx; industrial flat panels: IFPxxxx; industrial thin clients: ITCxxxx; industrial panel PC: IPCxxxx**

Elbow coupling 50/48 and 70/48
142.020.002 / 143.020.002



With the profiPLUS elbow coupling 50/48 or 70/48, it is possible to adapt profiPLUS 50 or profiPLUS 70 to a 48 mm round tube and therefore directly to many panel PC manufacturers (e.g. **SIEMENS Pro devices**). No additional coupling is needed. The range of rotation of the joint is 300°.

ROLEC-50/48 adapter
142.020.001 (including elbow)
142.024.100 (excluding elbow)



The profiPLUS 50/48 adapter elbow lets you adapt profiPLUS 50 to a 48 mm round tube and therefore to many panel PC manufacturers. No additional coupling is needed.

B&R adapter Ø 48 / Ø 62.5
142.000.008



The B&R adapter from ROLEC can be used with the profiPLUS couplings and therefore expands the range of rotation of the B&R **Panel PC 2100 (AP5000)**, **Panel PC 2200 (AP5000) multi-touch or single-touch suspension arm**.

B&R adapter Ø 48 profile
142.000.003



The B&R adapter Ø 48 profile is an economical variant in all instances where it is possible to dispense with an expanded range of rotation with the B&R **Panel PC 2100 (AP5000)**, **Panel PC 2200 (AP5000) multi-touch or single-touch suspension arm**.

The adapter is fastened directly to the profiPLUS profile. The costs for an additional coupling are omitted.

BECKHOFF adapter Ø 48
142.000.000



The ROLEC Beckhoff adapter is suitable for the following Beckhoff panel PCs: **CP32xx-0010 "Economy" PC panel**, **CP37xx multi-touch panel PC**, **CP39xx-0010 multi-touch control panel with CP Link 4** and **CP72xx-0010**.

profiPLUS 50 and 70

Reducer adapter 70/50

Stability over a great distance.

- The profiPLUS 70-50 adapter – the simple tool for longer distances and load-bearing capacities
- For using a profiPLUS 70 suspension arm with a wall or socket joint for bridging distances
- profiPLUS 70 ensures a stable horizontal system structure thanks to its high load-bearing capacity
- The 70-50 adapter reduces the profile size without load loss and allows the connection of small controls to a profiPLUS 50 coupling





Human. Design. Technology.

profiPLUS 50

Components



profiPLUS 50

The designer suspension arm system – components



Socket joint
142,005,000

Horizontal adjustment
Max. range of rotation 310°
RAL 7035/7016



Wall joint
142,010,000

Max. range of rotation 310°
RAL 7035/7016



Socket joint, vertical
142,005,001

Max. range of rotation 310°
RAL 7035/7016



Wall joint, vertical
142,010,001

Max. range of rotation 310°
RAL 7035/7016



Smart socket joint
142,005,200

Max. range of rotation 310°
RAL 7035/7016

Matching product additions:
Socket joint profile adaptation
Universal socket joint adaptation



Smart wall joint
142,010,200

Max. range of rotation 310°
RAL 7035/7016

Matching product additions:
Wall joint profile adaptation
Universal wall joint adaptation



Base
142,030,000

RAL 7035



Mobile base
142,030,160

RAL 7035
Including 4 rollers
Expandable with adjustable feet
Can be combined with upright couplings
Static load max. 60 kg



Intermediate joint
142,015,000

Max. range of rotation 310°
RAL 7035/7016



Elbow
142,020,000

RAL 7035/7016



Elbow coupling 50/48
142,020,002

For connection of panel PCs (e.g. SIEMENS Pro devices) with Ø 48 mm round tube frame
Max. range of rotation 300°
RAL 7035/7016

We also supply a Ø 48 mm round tube in RAL 7035



50/48 adapter
142.020.001 (including elbow)
142.024.100 (excluding elbow)

For connection of panel PCs with Ø 48 mm round tube frame
RAL 7035/7016

We also supply a Ø 48 mm round tube in RAL 7035



Coupling, upright
142.240.250 L = 250 mm
142.240.500 L = 500 mm
142.240.750 L = 750 mm
142.241.000 L = 1000 mm

Fitted support profile (length L)
Max. range of rotation 310°
RAL 7035



Coupling, hanging
142.250.250 L = 250 mm
142.250.500 L = 500 mm
142.250.750 L = 750 mm
142.251.000 L = 1000 mm

Fitted support profile (length L)
Max. range of rotation 310°
RAL 7035



Coupling N, upright
142.260.250 L = 250 mm
142.260.500 L = 500 mm
142.260.750 L = 750 mm
142.261.000 L = 1000 mm

Fitted support profile (length L)
Tilting 15° to the front
Tilting 35° to the rear
Max. range of rotation 310°
RAL 7035/7016





Coupling N, hanging
142.270.250 L = 250 mm
142.270.500 L = 500 mm
142.270.750 L = 750 mm
142.271.000 L = 1000 mm

Fitted support profile (length L)
Tilting 15° to the front
Tilting 35° to the rear
Max. range of rotation 310°
RAL 7035/7016

profiPLUS 50

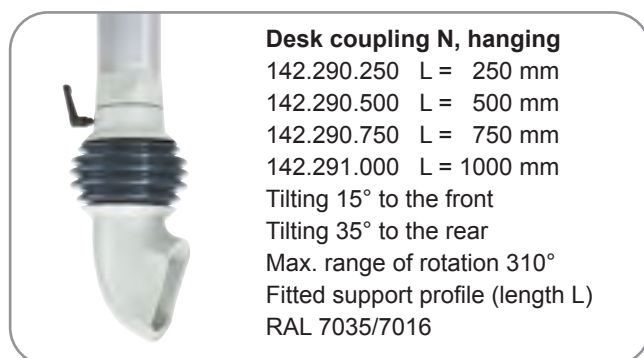
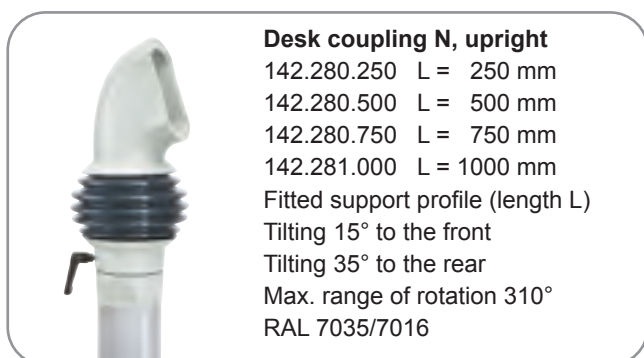
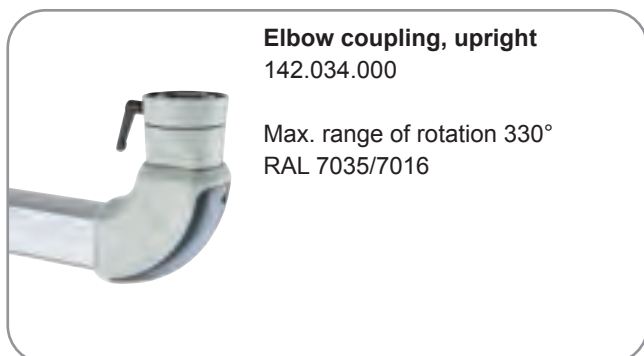
The designer suspension arm system – components





Panel coupling, upright
 142.220.250 L = 250 mm
 142.220.500 L = 500 mm
 142.220.750 L = 750 mm
 142.221.000 L = 1000 mm

Fitted support profile (length L)
 Max. range of rotation 330°
 RAL 7035



Panel coupling, hanging
 142.230.250 L = 250 mm
 142.230.500 L = 500 mm
 142.230.750 L = 750 mm
 142.231.000 L = 1000 mm

Fitted support profile (length L)
 Max. range of rotation 330°
 RAL 7035



Panel coupling N, upright
 142.310.250 L = 250 mm
 142.310.500 L = 500 mm
 142.310.750 L = 750 mm
 142.311.000 L = 1000 mm

Fitted support profile (length L)
 Tilting 15° to the front
 Tilting 35° to the rear
 Max. range of rotation 310°
 RAL 7035/7016



Panel coupling N, hanging
 142.300.250 L = 250 mm
 142.300.500 L = 500 mm
 142.300.750 L = 750 mm
 142.301.000 L = 1000 mm

Fitted support profile (length L)
 Tilting 15° to the front
 Tilting 35° to the rear
 Max. range of rotation 310°
 RAL 7035/7016



Elbow panel coupling, upright
 142.040.000

Max. range of rotation 330°
 RAL 7035/7016



Elbow panel coupling, hanging
 142.041.000

Max. range of rotation 330°
 RAL 7035/7016



Elbow panel coupling N, upright
 142.042.000

Tilting 15° to the front
 Tilting 35° to the rear
 Max. range of rotation 310°
 RAL 7035/7016



Elbow panel coupling N, hanging
 142.043.000

Tilting 15° to the front
 Tilting 35° to the rear
 Max. range of rotation 310°
 RAL 7035/7016

profiPLUS 50

The designer suspension arm system – components



Support profile
142.000.250 L = 250 mm
142.000.500 L = 500 mm
142.000.750 L = 750 mm
142.001.000 L = 1000 mm
142.001.500 L = 1500 mm
Fitted support profile (length L)
Extruded aluminium profile
silver anodised



Wall Pivot Mount S
501.101.300
Fits all profiPANEL basic profile
depths (page 15)
RAL 7035

501.100.200
Fits all multiPANEL depths,
RAL 9005, Range of rotation 138°,
Max. load-bearing capacity 20 kg



Signal light adaptor
142.020.501
Wall joint, socket joint,
Intermediate joint

142.020.502
Elbows, elbow couplings,
Elbow desk couplings

RAL 7016



Wall Pivot Mount L
501.100.300
Fits profiPANEL depths
150, 180, 210 (page 15)
RAL 7035



Beckhoff adaptor Ø 48
142.000.000

RAL 7035



SIEMENS adaptor
142.024.000

RAL 7035



B&R adaptor Ø 48 profile
142.000.003

RAL 7035



B&R adaptor Ø 48 / 62.5
142.000.008

Max. range of rotation 310°
RAL 7035

70/50 adapter
143.000.001



For reducing from
profiPLUS 70 to 50
RAL 7035

VESA adaptor
142.000.005



Coupling for VESA 75 and 100
Maximum load 20 kg
RAL 9005

**VESA adapter desk
connection**
142.000.024



RAL 9005

Suitable for desk coupling and
elbow desk coupling for the
adaptation of VESA drilling
patterns

**Universal adaptor
Socket or wall joint**
142.026.XXX / 142.025.XXX



RAL 7035

Suitable for socket or wall joint
smart for adapting existing drilling
patterns

**Profile adaptor
Socket or wall joint**
142.024.300 / 142.024.200



RAL 7035



Fits with socket or wall joint smart
for attachment on structural
machine profiles such as those by
ITEM or Bosch

Technical data

System components

Die cast aluminium, RAL 7035 light grey

Covers

Thermoplast, RAL 7016 anthracite grey

Bellows

PVC-P, RAL 7016 anthracite grey

Support profile

Extruded aluminium profile, silver anodised

Gasket

Chloroprene (CR)

Ingress protection

IP54 / EN 60529

Equipotential bonding

DIN EN 60204-1 / VDE 0113-1

Patented

Alignment of the complete system structure
in a horizontal direction with a set screw

OPTIONAL:

Coating

Special colours for
system elements

**Matching command
enclosures**

profiPANEL, multiPANEL,
commandCASE, aluFACE

profiPLUS 70

Components



Socket joint

143.005.000

Horizontal adjustment
Max. range of rotation 310°
RAL 7035/7016



Wall joint

143.010.000

Max. range of rotation 310°
RAL 7035/7016



Socket joint, vertical

143.005.001

Max. range of rotation 310°
RAL 7035/7016



Wall joint, vertical

143.010.001

Max. range of rotation 310°
RAL 7035/7016



Base

143.030.000

RAL 7035



Mobile base

143.030.160

RAL 7035
Including 4 rollers
Expandable with adjustable feet
Can be combined with upright couplings
Static load max. 60 kg



Intermediate joint

143.015.000

Max. range of rotation 310°
RAL 7035/7016



Elbow

143.020.000

RAL 7035/7016



profiPLUS 70

The designer suspension arm system – components



Elbow coupling 70/48
143.020.002
For connection of panel PCs
(e.g. SIEMENS Pro devices) with
Ø 48 mm round tube frame
Max. range of rotation 300°
RAL 7035/7016
We also supply a
Ø 48 mm round tube in RAL 7035



Signal light adaptation
143.020.501
Wall joint, socket joint,
Intermediate joint

143.020.502
Elbows, elbow couplings,
Elbow desk couplings

RAL 7016



Coupling, upright
143.240.250 L = 250 mm
143.240.500 L = 500 mm
143.240.750 L = 750 mm
143.241.000 L = 1000 mm

Fitted support profile (length L)
Max. range of rotation 310°
RAL 7035



Coupling, hanging
143.250.250 L = 250 mm
143.250.500 L = 500 mm
143.250.750 L = 750 mm
143.251.000 L = 1000 mm

Fitted support profile (length L)
Max. range of rotation 310°
RAL 7035



Coupling N, upright
143.260.250 L = 250 mm
143.260.500 L = 500 mm
143.260.750 L = 750 mm
143.261.000 L = 1000 mm
Fitted support profile (length L)
Tilting 15° to the front
Tilting 35° to the rear
Max. range of rotation 310°
RAL 7035/7016



Coupling N, hanging
143.270.250 L = 250 mm
143.270.500 L = 500 mm
143.270.750 L = 750 mm
143.271.000 L = 1000 mm
Fitted support profile (length L)
Tilting 15° to the front
Tilting 35° to the rear
Max. range of rotation 310°
RAL 7035/7016



Elbow coupling, upright
143.034.000

Max. range of rotation 310°
RAL 7035/7016



Elbow coupling, hanging
143.035.000

Max. range of rotation 310°
RAL 7035/7016



Elbow coupling N, upright
143.036.000

Tilting 15° to the front
Tilting 35° to the rear
Max. range of rotation 310°
RAL 7035/7016



Elbow coupling N, hanging
143.037.000

Tilting 15° to the front
Tilting 35° to the rear
Max. range of rotation 310°
RAL 7035/7016



Desk coupling N, upright
143.280.250 L = 250 mm
143.280.500 L = 500 mm
143.280.750 L = 750 mm
143.281.000 L = 1000 mm
Fitted support profile (length L)
Tilting 15° to the front
Tilting 35° to the rear
Max. range of rotation 310°
RAL 7035/7016



Desk coupling N, hanging
143.290.250 L = 250 mm
143.290.500 L = 500 mm
143.290.750 L = 750 mm
143.291.000 L = 1000 mm
Fitted support profile (length L)
Tilting 15° to the front
Tilting 35° to the rear
Max. range of rotation 310°
RAL 7035/7016



Elbow desk coupling N, upright
143.038.000

Tilting 15° to the front
Tilting 35° to the rear
Max. range of rotation 310°
RAL 7035/7016



Elbow desk coupling N, hanging
143.039.000

Tilting 15° to the front
Tilting 35° to the rear
Max. range of rotation 310°
RAL 7035/7016



Support profile
143.000.250 L = 250 mm
143.000.500 L = 500 mm
143.000.750 L = 750 mm
143.001.000 L = 1000 mm
143.001.500 L = 1500 mm
Support profile (length L)
Extruded aluminium profile
silver anodised

Technical data

Please refer to the profiPLUS 70 technical data on page 45. This is identical to profiPLUS 50.

taraSMART

The perfect addition to profiPANEL and multiPANEL





Human. Design. Technology.

The key product features of taraSMART at a glance:

- Tried and tested technology, modern design
- Suitable for routing connectors such as HDMI, DVI or network adapters
- Quick and easy assembly
- Simple adaptation of panel PCs with a round tube frame
- Ingress protection IP54

Use our practical suspension arm configurator
at rolec.com

taraSMART

The perfect addition to profiPANEL and multiPANEL

Fastening options at or on the machine body:

- Five fastening options
- Small fastening dimensions (from 90 x 90 mm)
- Perfect symbiosis of system components with your machine's mounting surface
- Socket and wall joint vertical and base also possible as overhead assembly



Round or angular? After the elbow, how should things proceed?

Thanks to both elbow variants "Profile elbow" and "Ø48 Elbow", you have the option of adapting to an HMI control enclosure using one of the couplings from the taraSMART system.

Using the Ø48 elbow, you can directly connect all panel PCs that have a frame for a Ø48 round tube. No coupling is required for this.





- 1 **Profile panel coupling**
for connecting to narrow HMI enclosures, e.g. multiPANEL
- 2 **Panel coupling Ø48**
for connecting to narrow HMI enclosures, e.g. multiPANEL
- 3 **Profile coupling**
- 4 **Coupling Ø48**
- 5 **Round tube Ø48**
for the direct connection of Panel PCs with a round tube frame

Options for connecting to individual command enclosures and panel PCs made by leading manufacturers with a round tube frame.

We present the latest generation of modern suspension arm technology with the taraSMART design. This harmonises perfectly with that of modern machines. taraSMART makes time-saving assembly possible with internal cable routing. Practical rotation limitation is integrated as a standard. The aesthetic and stable design leaves nothing to be desired on a technical level.

Intelligent components make almost any conceivable set-up combination possible. Thanks to the adaptation option with the elbow onto a Ø48 round tube, numerous panel PCs made by leading manufacturers can be connected quickly and easily. Using the tapered panel coupling, narrower HMI enclosures can be easily connected.



taraSMART

The perfect addition to profiPANEL and multiPANEL

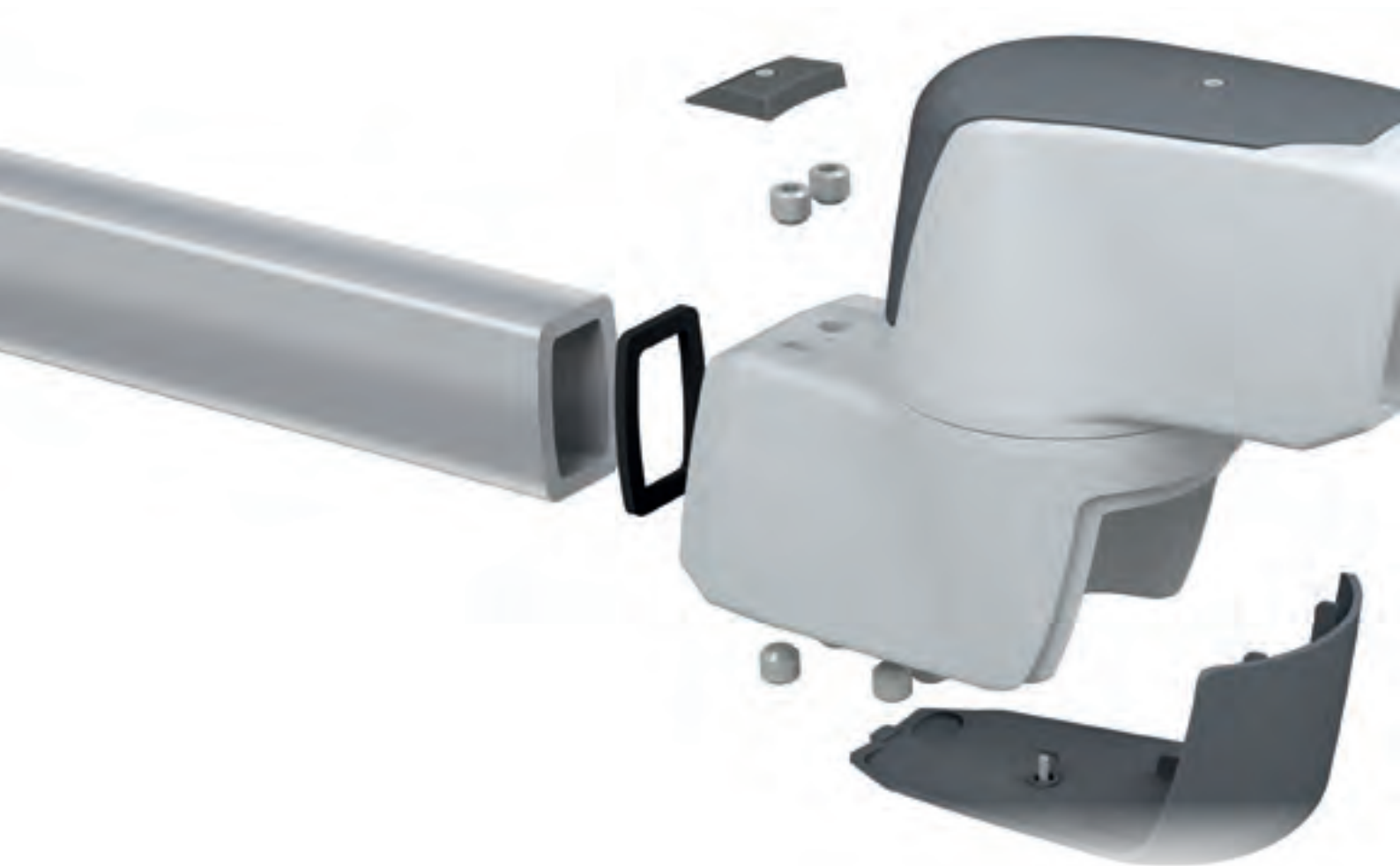

The precision of tried and tested technology.

For taraSMART, our designers, mechanical engineers and developers have recollected that the best things are often very simple. Also here, less is more. Therefore, the inside of taraSMART has been reduced to the essentials. Tried and tested technology with a modern look.

The slim and elegant design of the system components protects the cables inside of the system against excessive friction and guarantees continuous functionality of the connections made.



Human. Design. Technology.



Easy assembly, perfect adjustment.

In addition to a modern look, naturally, easy assembly is what primarily counts. Here too, taraSMART is impressive. The assembly of the system components is very simple and can be performed correspondingly quickly.

The horizontal adjustment of the system is performed via a tried and tested principle that has already been used for other ROLEC suspension arm systems. It allows for optimal adjustment of the system at all joints.

taraSMART

System configuration examples



A great deal of interior space.

Both in the case of the profile as well as in the case of the Ø48 round tube, taraSMART offers a great deal of space for the routing of cables, such as HDMI cables, DVI cables or network adapters. Routing through the inside of the profiles can be performed quite quickly and easily thanks to the straight inner walls. In the adjacent graphic, you can see how the load-bearing capacity of the system behaves as the system length becomes longer and how it behaves without an intermediate joint.

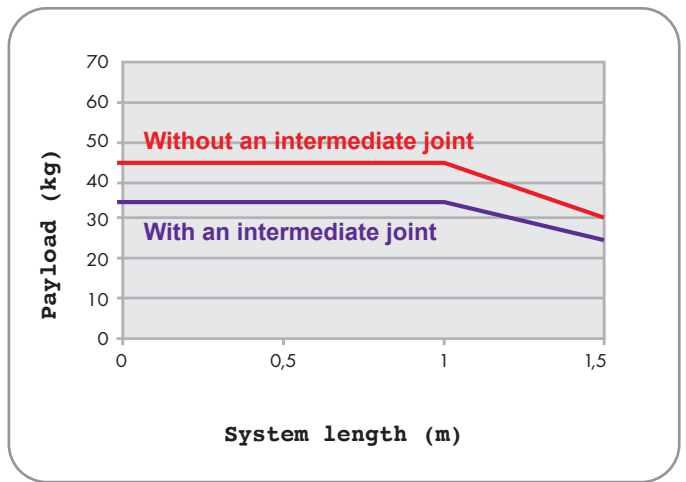

Preparation for Conta-Clip KDS-FB1 Preparation for Conta-Clip KDS-FB2 Preparation for Conta-Clip KDS-FB3 Preparation for Conta-Clip KDS-FB4

Profile preparation for cable outlet.

For everyone who has to lay the cables above the floor, we offer the option of preparing openings and fastening points in the taraSMART profile for e.g. Conta-Clip cable entry points.

Thanks to its select system elements, taraSMART offers a whole host of combination options for individual suspension arm configuration. The example variants presented here serve as orientation aids and examples of the

diversity. ROLEC's team will be happy to advise you on the configuration of a suspension arm tailored specifically to your requirements.

- 1 Wall joint
- 2 Socket joint
- 3 Base
- 4 Intermediate joint

- 5 Profile elbow
- 6 Ø48 elbow
- 7 Profile panel coupling
- 8 Coupling Ø48

- 9 Panel coupling Ø48
- T Support profile, length is variable
- R Ø48 round tube, length is variable

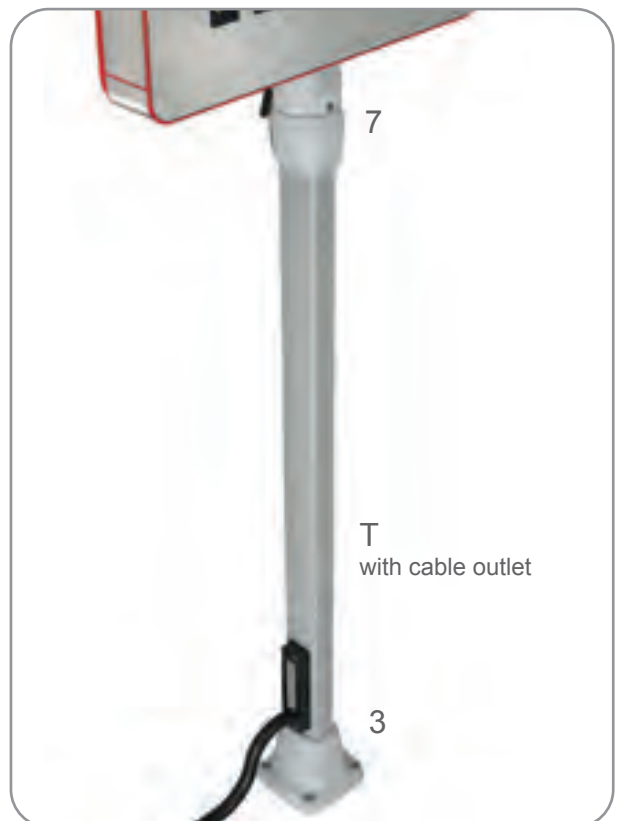
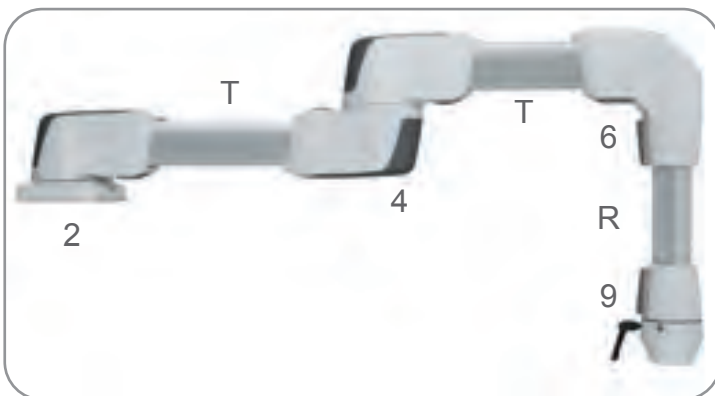
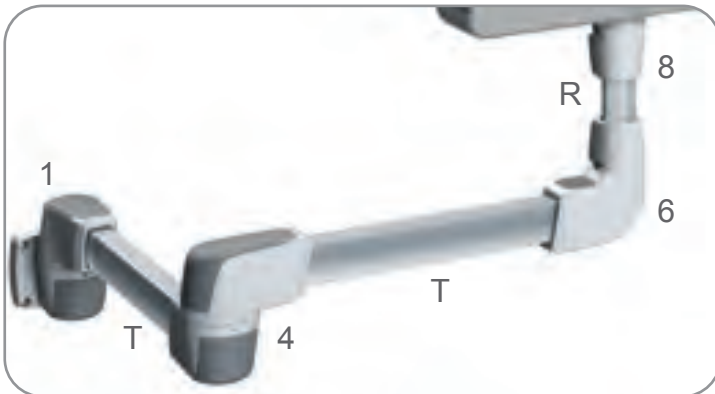

taraSMART

The evolution of a classic – system components

Socket joint
141.005.000

Max. range of rotation 300°
RAL 7035/7016



Wall joint
141.010.000

Max. range of rotation 230°
RAL 7035/7016



Socket joint vertical
141.005.001

Max. range of rotation 300°
RAL 7035/7016



Wall joint vertical
141.010.001

Max. range of rotation 300°
RAL 7035/7016



Base
141.030.000

RAL 7035/7016



Intermediate joint
141.015.000

Max. range of rotation 300°
RAL 7035/7016



Profile elbow
141.020.000

RAL 7035/7016



Ø48 elbow
141.020.001

RAL 7035/7016



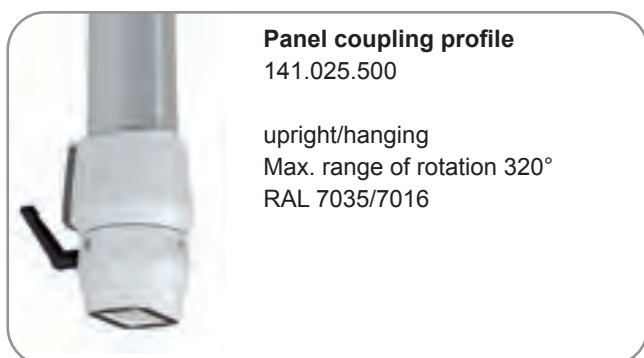

Panel coupling profile

141.025.500

upright/hanging
Max. range of rotation 320°
RAL 7035/7016

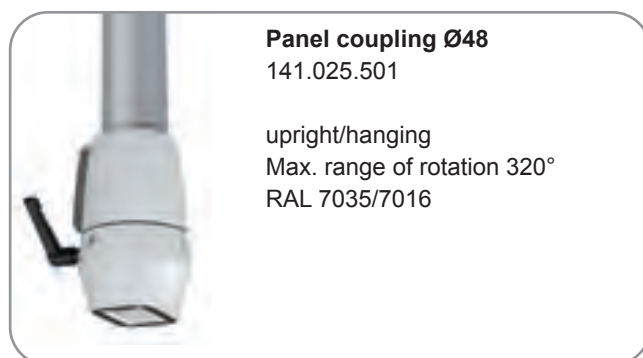

Panel coupling Ø48

141.025.501

upright/hanging
Max. range of rotation 320°
RAL 7035/7016

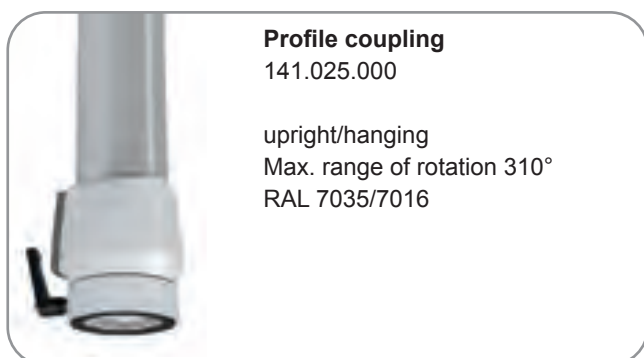

Profile coupling

141.025.000

upright/hanging
Max. range of rotation 310°
RAL 7035/7016

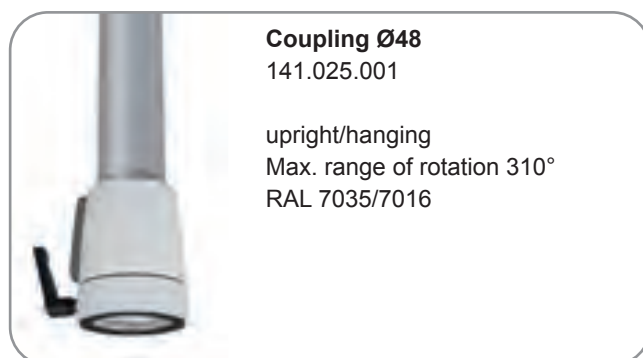

Coupling Ø48

141.025.001

upright/hanging
Max. range of rotation 310°
RAL 7035/7016

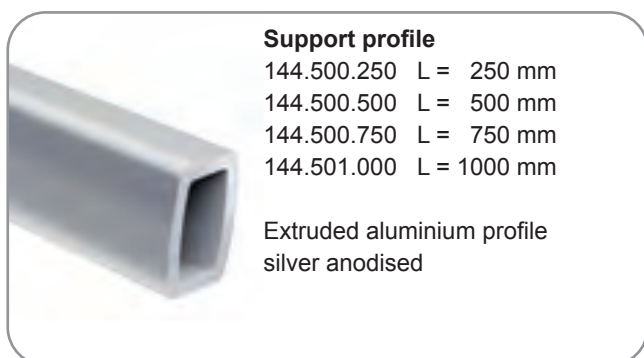

Support profile

144.500.250 L = 250 mm
144.500.500 L = 500 mm
144.500.750 L = 750 mm
144.501.000 L = 1000 mm

Extruded aluminium profile
silver anodised



Round tube Ø48

144.510.250 L = 250 mm
144.510.500 L = 500 mm
144.510.750 L = 750 mm
144.511.000 L = 1000 mm

Steel
silver-coated

Technical data

System components

Die cast aluminium, RAL 7035

Covers

Thermoplast, RAL 7016

Support profile

Extruded aluminium profile, silver anodised
Round tube Ø48, silver-coated

Gasket

Chloroprene (CR)

Ingress protection

IP54 / EN 60529

OPTIONAL:

Coating

Special colours for system elements

Matching command enclosures

profiPANEL, multiPANEL,
commandCASE, aluFACE



Human .
Design .
Technology .



ROLEC
Gehäuse-Systeme GmbH
Kreuzbreite 2
31737 Rinteln – Deutschland

Fon +49 5751 4003-0
Fax +49 5751 4003-50
info@rolec.com
rolec.com

