

PRODUCT OVERVIEW

# Passion for the best solution

Cable glands, cable trunking  
and cable protection

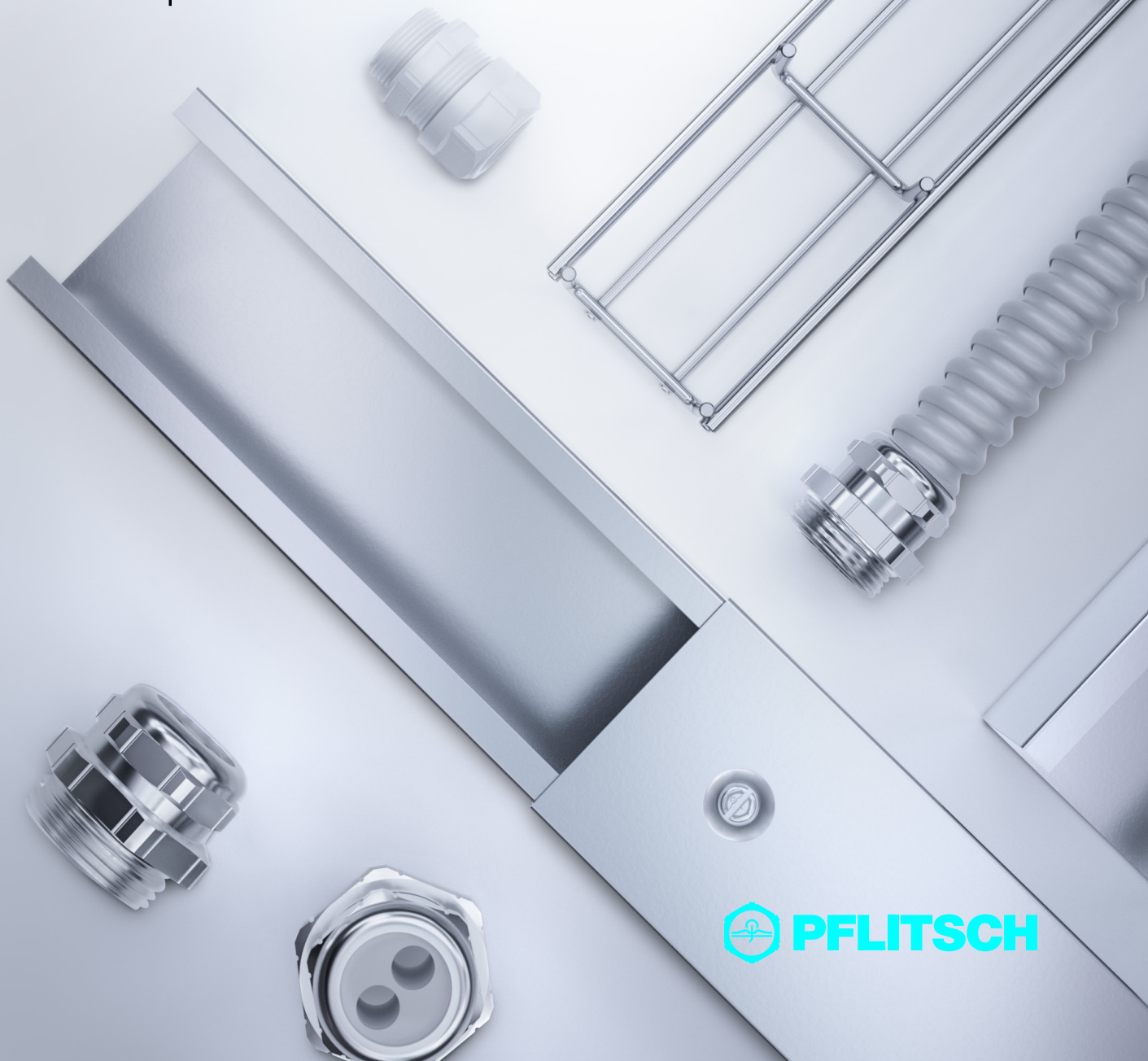

# Your success is what drives us – we do our best for that

## Tailor-made solutions for individual customer needs

For more than 100 years PFLITSCH has inspired customers all over the world. Now we would like to inspire you – with the **best solution for your application** and one that is sure to enhance your processes. We can make this promise to you because we are not only extremely familiar with the requirements of various industries, such as mechanical engineering, robotic & automation, railway industry, chemicals, food processing and pharmaceuticals, but are also committed to fulfilling the specific requirements of our customers. The result is an **intelligent system** of solutions for cable routing, cable glands and cable protection. Furthermore, should you find none of our solutions are suitable for your needs, we will set about finding an **individualised solution** for you.

To be certain that the best solution is the most suitable, that it functions reliably and has the longest-possible service life, we put a great deal of time and effort into quality management. **Certifications** and **stringent testing** ensure you receive products that consistently meet our high standards. And because the best solution today will not automatically still be the best tomorrow, we are continually working on innovations and product improvements. This includes continuously seeking feedback and opinions from our customers, with whom we are in close contact through a worldwide network of sales partners.

All this shows that we are on the right track: PFLITSCH products have long stood for **quality "made in Germany"** worldwide.

## Cable glands

<b>blueglobe</b> – large sealing ranges	4
<b>UNI Dicht</b> – modular system	5
<b>Splittable cable glands</b> – solution for sealing pre-assembled cables	6
<b>EMC cable glands</b> – reliable attenuation	7
<b>Ex cable glands</b> – protection for potentially explosive atmospheres	8

## Cable protection

<b>Hose cable glands</b>	9
<b>hose glands</b>	
<b>hoses and corrugated conduits</b> – perfect cable protection	

## Cable trunking

<b>Industrial-Trunking</b> – safe cable routing with system	10
<b>VARiOX-Trunking</b> – efficiently masters standard applications	11
<b>PIK-Trunking</b> – routing small numbers of cables	12
<b>Wire-tray Trunking</b> – open and clear cable routing	13
<b>Component assemblies service</b> – ready-to-install trunking layouts	14
<b>Machines and tools</b> – DIY cable trunking assembly	15

# blueglobe

**Your solution**  
that covers large sealing ranges with just a single cable gland



blueglobe cable gland

# UNI Dicht

**Your solution**  
for all applications – thanks to the modular system

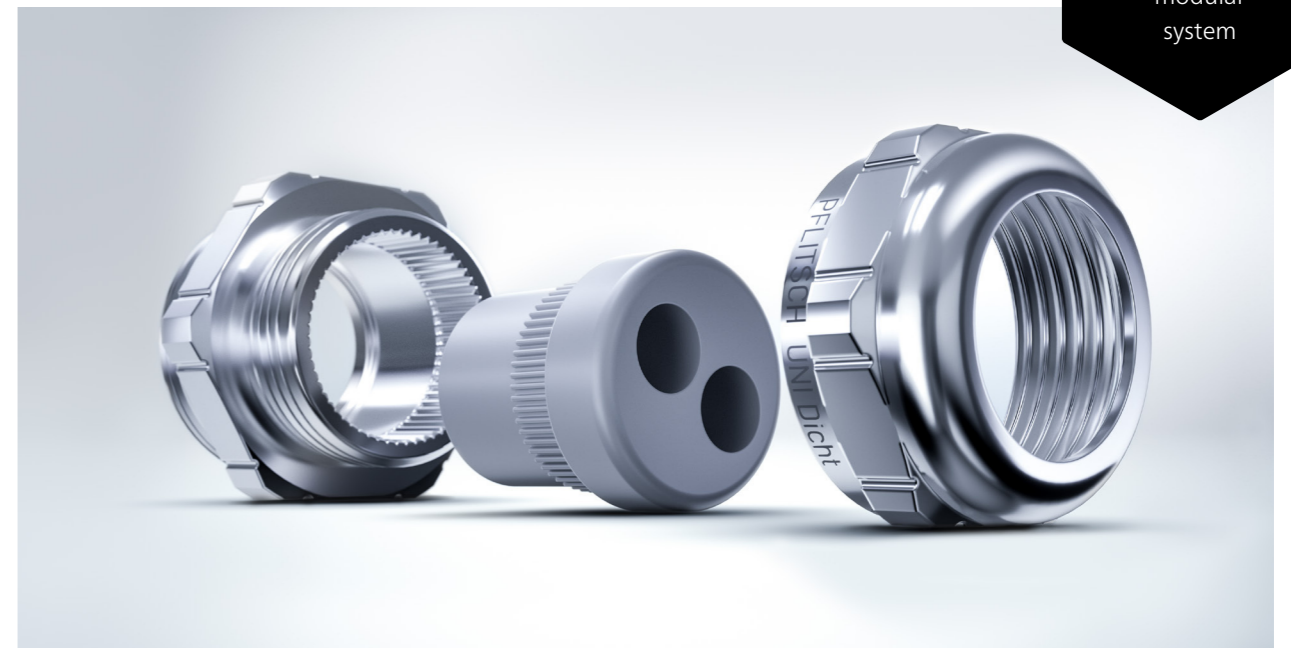

Cable gland UNI Dicht with multiple sealing insert



### What you require

- » Realise large sealing ranges with only one cable gland size and maximum tightness
- » High strain relief, maximum degree of protection, operational safety, resistance as well as high durability even with strong vibrations
- » Versions for use in explosion hazard, fire protection, EMC, hygiene and high-temperature environments

### Our product solutions

- » Low number of parts for a wide range of applications
- » sealing ranges from 2 mm to 76 mm of cable diameter
- » Spherical sealing insert ensures very high strain relief up to class B, EN 62444
- » Large-area sealing prevents damage to the cable
- » Clear markings on the pressure screw and sealing insert
- » Variant available for hygienic applications certified by EHEDG and DGUV
- » Explosion protection and EMC solutions as well as variants for extreme environmental temperature and fire protection according to EN 45545
- » High-pressure variant fulfils protection type IP 68 up to 30 bar (up to one hour)

Material gland body	Nickel-plated brass, stainless steel and PA plastic
Material sealing inserts	TPE, TPU and high-temperature silicone
Thread connection sizes	M8 to M85
Protection type	IP 68 up to 15 bar and IP 69 and type 4X

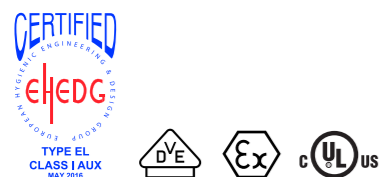

### What you require

- » High degree of protection, operational safety, resistance and durability
- » Securely seal several cables of different diameters in a single hole
- » Easy compiling of individual solutions for standard and special applications
- » Versions for use in explosion hazard, EMC and high-temperature environments

### Our product solutions

- » Modular system with more than 6,000 components facilitates individual solutions
- » Sealing inserts for single or multiple cables, flat and special cables and for pre-assembled cables
- » "Soft pinching" ensures high types of protection
- » Metric and Pg connection threads together with NPT and inch connection threads
- » Elbow cable glands for routing cables through 90° corners
- » Can be combined with hoses
- » Safe applications with explosion protection and EMC variants
- » Fire protection solutions complying with EN 45545

Material gland body	Nickel-plated brass, stainless steel, PC and PVDF plastic
Material sealing inserts	TPE, TPE-V and silicone that are highly resistant and have a wide range of operation temperatures
Thread connection sizes	M4 to M120/Pg 7 to Pg 48/ G1/4" bis G3"/NPT3/8" to NPT2"
Protection type	IP 68 up to 10 bar and IP 69





# Splittable cable glands

Your solution  
for sealing  
pre-assembled  
cables

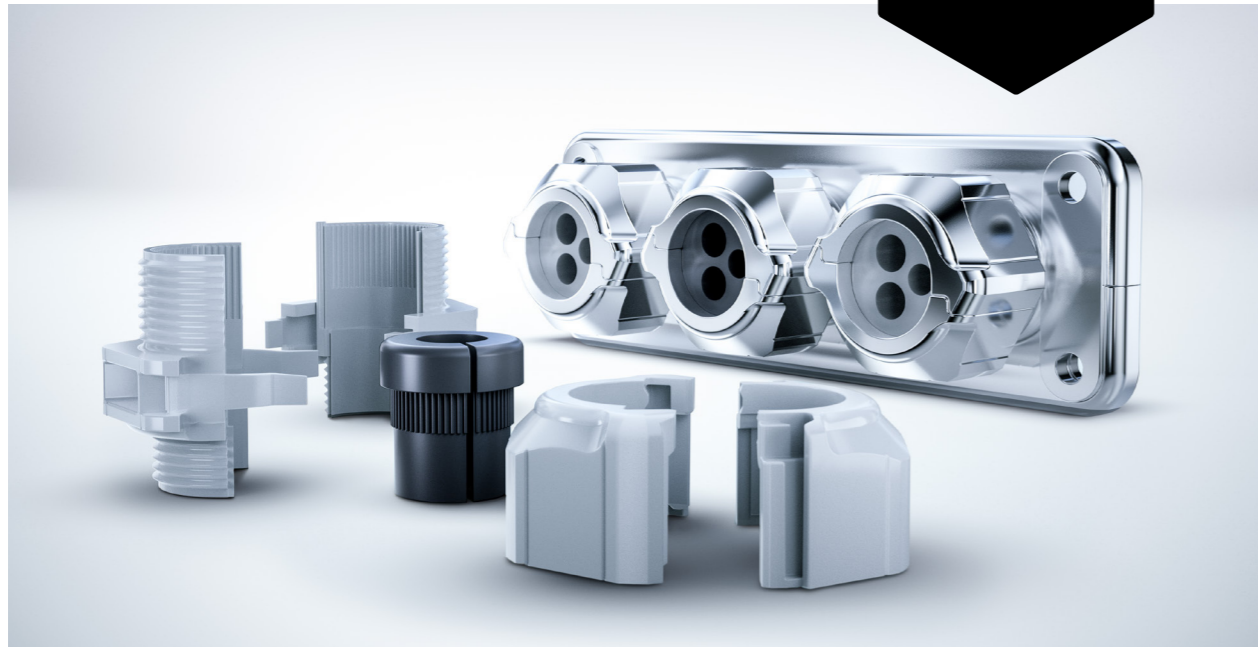

Completely splittable – UNI Split Gland and UNI flange HD



### What you require

- » Secure sealing of cables and pre-assembled cables with plugs
- » Quick and easy assembly, also outside the production process
- » Secure sealing of several cables of different diameters in a single hole

### Our product solutions

- » Fully splittable cable gland systems
- » No need to disconnect cables or disassemble plugs – the cable gland systems can be installed around the cables
- » Cable gland UNI Split Gland in sizes M20–M32 and UNI flange HD system for standard hole cut-outs for 24-pole connectors
- » Quick and easy installation of pre-assembled cables
- » Large selection of split sealing inserts from the UNI Dicht system
- » Outstanding strain relief values in accordance with EN 62444
- » Fire protection according to EN 45546

Material gland body	Zinc die-cast, PC and PA plastic
Material sealing inserts	TPE and TPE-V
Protection type	IP 66 and IP 67

# EMC cable glands

Your solution  
for reliable  
shielding of  
electromagnetic  
waves



blueglobe TRI made of brass



### What you require

- » High shielding and high current-carrying capacity
- » Possibilities for use in special applications, e.g. explosion hazard, hygiene, fire protection or high-temperature environments
- » Quick and easy installation

### Our product solutions

- » Broad product range of EMC cable glands with spring, cone and clamping ring for different applications
- » Secure contact to the cable shield ensures high shielding such as the 360° contact of the patented TRI spring from the blueglobe series
- » High current-carrying capacity
- » “Soft pinching” sealing principle
- » Variants for hygienic applications certified according to EHEDG and DGUV as well as solutions for explosion protection and the railway industry
- » Space saving through EMC contacting multiple cables with only one cable gland
- » EMC adapter as an extension for standard cable glands
- » KoKeT – a measurement system developed by PFLITSCH to determine the shielding effect in accordance with IEC standard 62153-4-10

Material gland body	Nickel-plated brass and stainless steel
Material sealing inserts	TPE, TPE-V and high-temperature silicone
Thread connection sizes	M10 to M85/Pg 9 to Pg 48
Protection type	IP 68 up to 15 bar and IP 69 and type 4X

## Ex cable glands



LevelEx cable gland with cascading sealing system

**Your solution**  
with certified protection for potentially explosive atmospheres

## Hose cable glands, hose glands, hoses and corrugated conduits

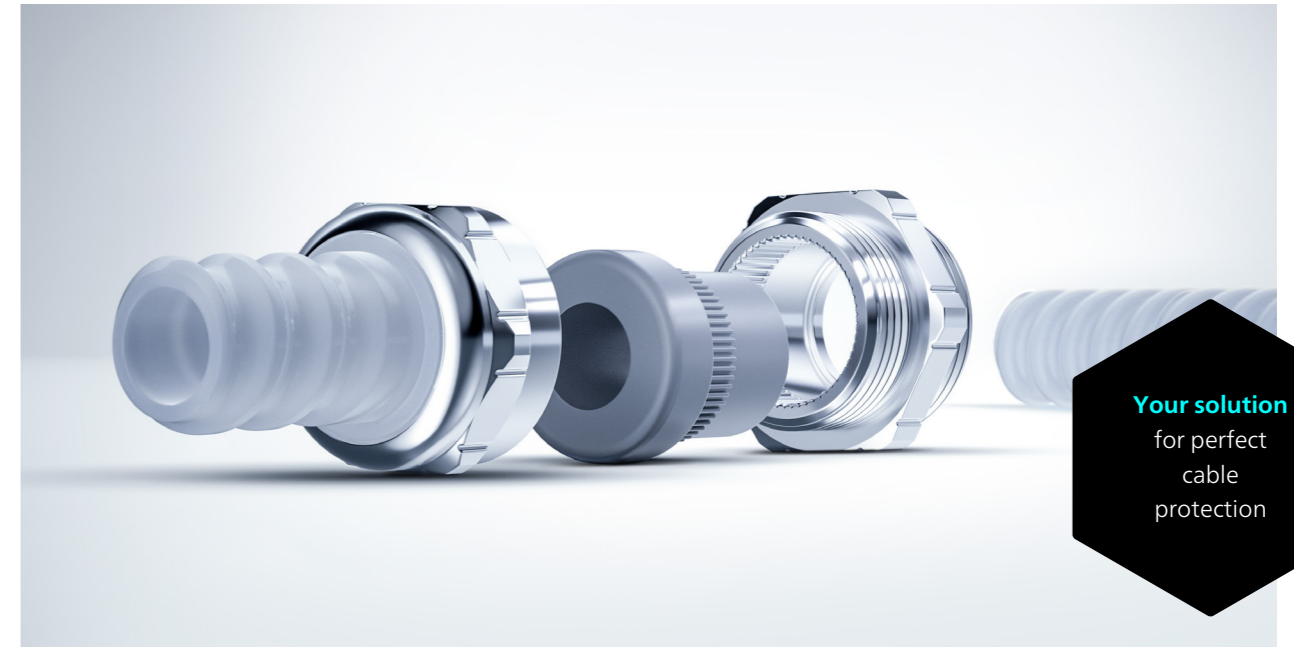

UNI UL Dicht hose cable gland with UL hose

**Your solution**  
for perfect cable protection



### What you require

- » Certified according to current ATEX guidelines for maximum safety
- » Approval for equipment class II and explosion protection types "d", "e" and "t"
- » Also available as an EMC variant and for sealing several cables of different diameters in a single hole

### Our product solutions

- » Certified ignition protection types for equipment class II are "d" (pressure-resistant encapsulation), "e" (increased safety) and "t" (Protection through housing)
- » Variants can be used in potentially explosive zones 1, 2, 20, 21 and 22
- » Ex-e: UNI Dicht and blueglobe programme without affecting the known product characteristics
- » Ex d/Ex e: LevelEx series with cascading sealing principle
- » Current approvals such as ATEX, IECEx, EAC, DNV, UL, CCC and KCS
- » EMC variants
- » Multiple cable glands

Material gland body	Brass and stainless steel
Material sealing inserts	TPE and high-temperature silicone
Thread connection sizes	M10 - M85/NPT3/8" to NPT2 1/2"
Protection type	IP 68 up to 15 bar



### What you require

- » Optimum cable protection against mechanical, thermal or chemical influences
- » Easy combination with different hoses and corrugated conduits
- » Easy compiling of individual solutions for standard and special applications

### Our product solutions

- » Cable glands with hose adapters compatible with the UNI Dicht system
- » The UNI Dicht sealing principle ensures reliable cable sealing
- » Hose cable glands with EMC protection
- » Flexible and secure cable protection with the PFLITSCH tube and corrugated conduit programme for the most demanding industrial applications
- » Wide range of applications thanks to the UNI Dicht modular system

Material gland body	Nickel-plated brass, PA and PVDF plastic
Protection type	IP 68
Hose types	Corrugated conduit, spiral tube, UL tube, protective tube

# Industrial-Trunking

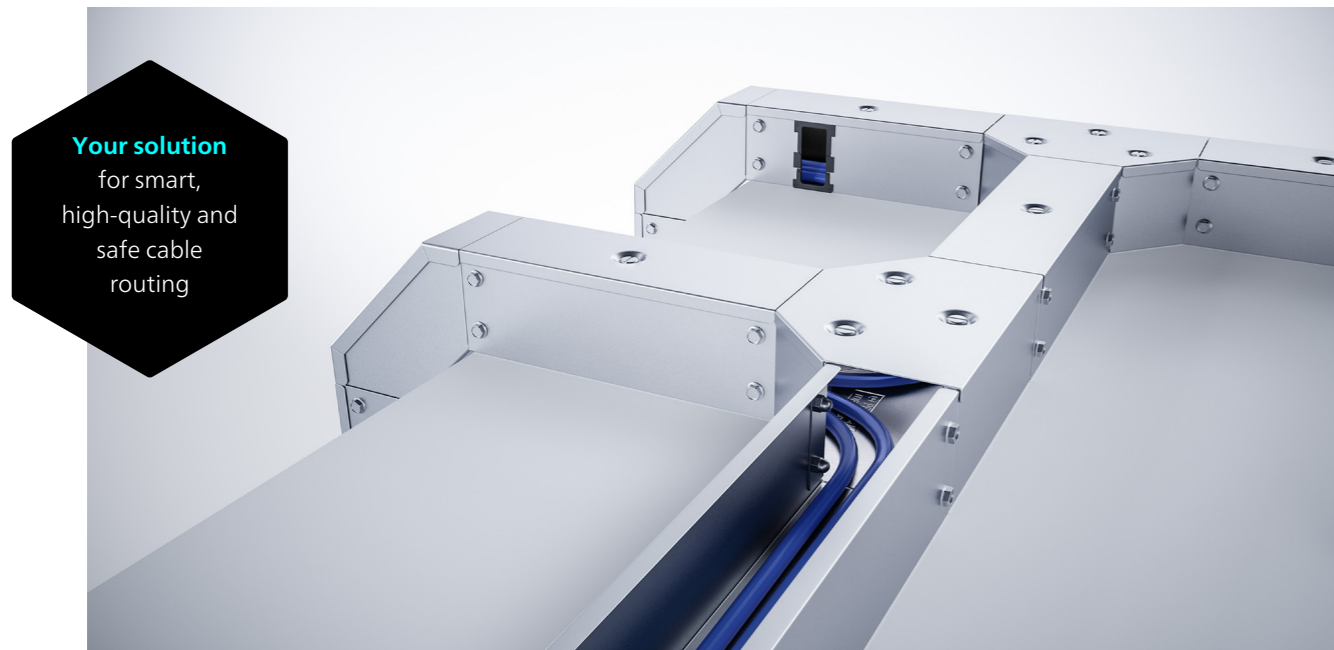

**Your solution**  
for smart,  
high-quality and  
safe cable  
routing

Industrial-Trunking component assemblies

# VARIiOX-Trunking



**Your solution**  
that efficiently  
masters all standard  
applications

VARIiOX-Trunking component assemblies



## What you require

- » Robust cable trunking system with a wide range of component shapes for customised routes
- » Efficient routing of large numbers of cables over long distances
- » Easy to open for inserting and removing cables

## Our product solutions

- » Individual three dimensional routing using accessory fittings such as angles, outlets or crossings
- » The trunking can be opened in various cover positions over the entire length. Benefit: The cables can be inserted easily
- » Pressed-in, self securing cap nuts for fast and easy installation
- » Robust and low burr construction with UL certificate
- » Different cover latches are available
- » Extensive accessories: full edge protection, high quality fastenings and secure equipotential bonding (VDE approved)
- » The trunking routing can be designed using the 3D planning tool easyRoute
- » Automobile-Trunking for floor-mounted installation with walk-on loading of up to 1,200 N
- » Comprehensive range of machines and tools for cutting trunking to length and making cut-outs
- » Available as ready-to-install component assemblies

Material trunk and cover	Sheet steel, stainless steel, aluminium, can be painted according to the customer's specifications
Profiles	50 mm x 50 mm up to 600 mm x 150 mm



## What you require

- » Cover long distances quickly and easily
- » Small number of components for efficient assembly and storage
- » Easy to open, even without tools

## Our product solutions

- » Innovative trunking system with a manageable level of component diversity – the clever solution for all standard applications
- » VARIiOX Quick connectors and self-engaging covers allow trunking to be quickly and easily installed without additional tools
- » VARIiOX Quick connectors cleverly invert to allow snap-in or screwed assembly of trunking components
- » The VARIiOX modular system consisting of various sizes and accessory fittings – can be modified or added to at any time using components from PFLITSCH Industrial-Trunking
- » Simple to cut and shape using PFLITSCH machines and tools
- » Highly economic: The simple yet comprehensive system is efficient to design, easy to handle and quick to install

Material trunk and cover	Sheet steel
Profiles	100 mm x 100 mm up to 300 mm x 100 mm



# PIK-Trunking

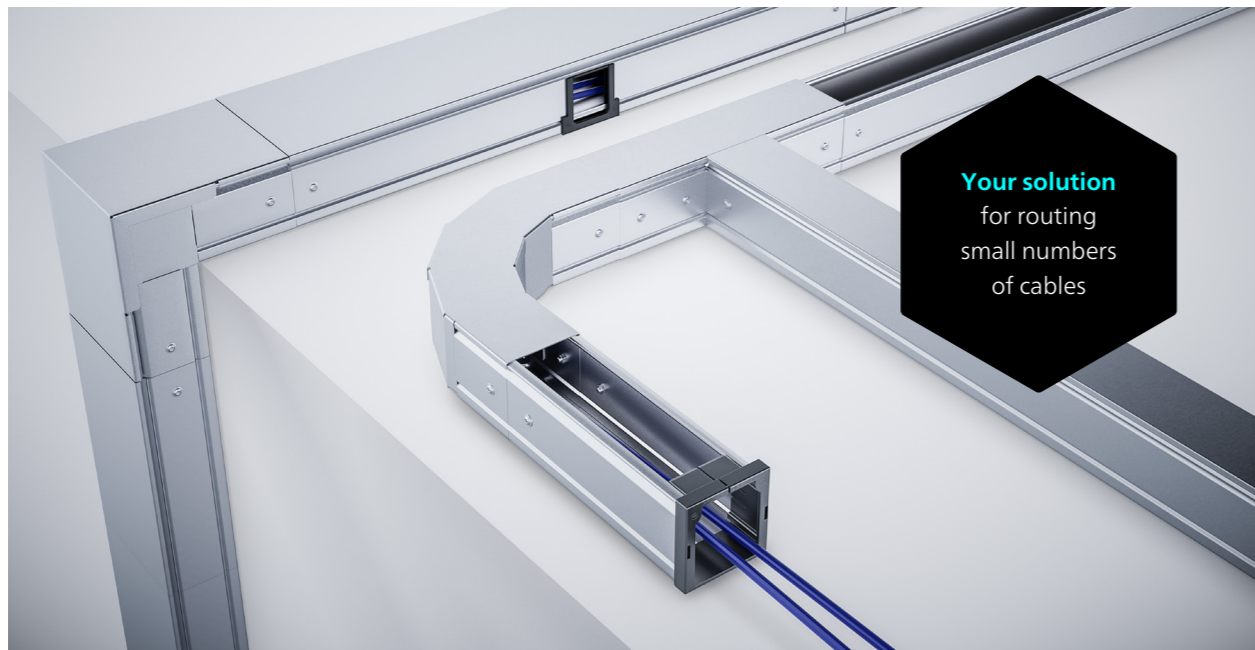

PIK-Trunking component assemblies

# Wire-tray Trunking

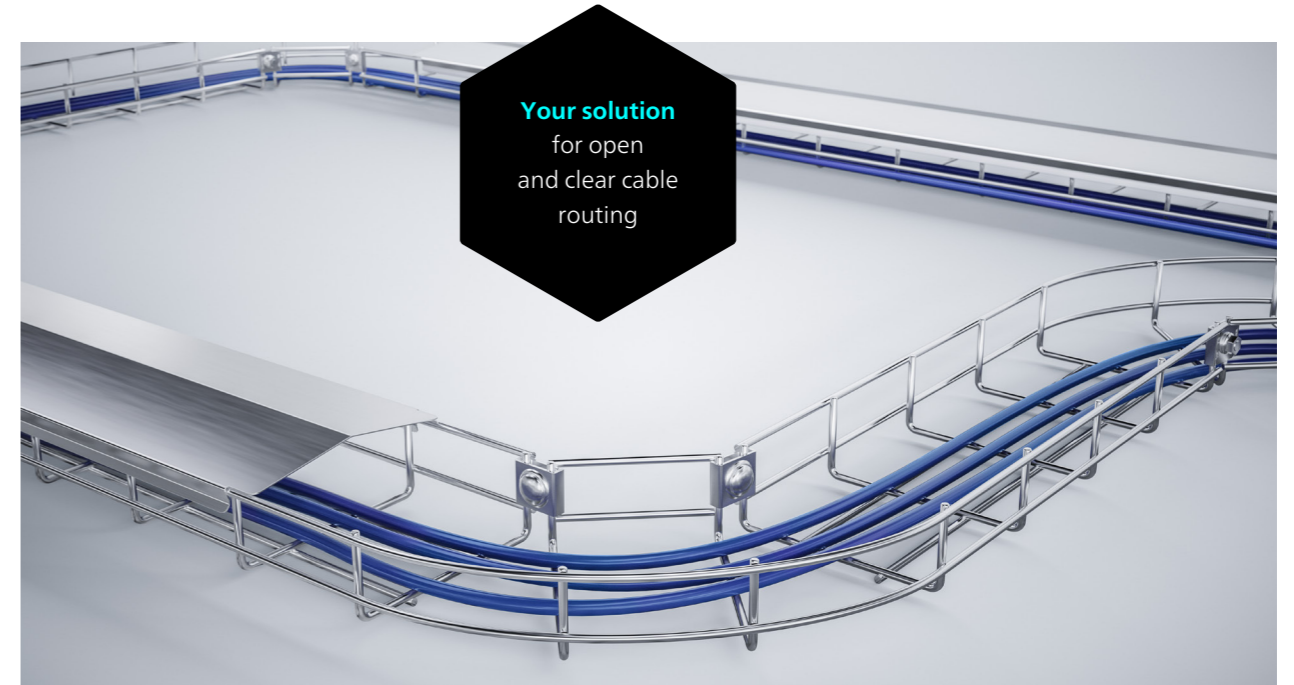

Wire-tray Trunking component assemblies



### What you require

- » Safe routing of small numbers of cables – including through tight spaces
- » Easy to open over its entire length
- » High dimensional stability and reliable edge protection

### Our product solutions

- » Installation trunking for a small number of cables
- » Cables can be inserted over the whole length
- » Holding clamps for all PIK sizes for a fast installation and a secure equipotential bonding
- » Can be combined with the Industrial-Trunking
- » Can be closed with the practical snap-on cover
- » Accessory fittings can be used to achieve three-dimensional trunking routing
- » Edge protection for lateral cable outlets and at the end of the trunking
- » Machines and tools for working with the trunking
- » Available as ready-to-install component assemblies

Material	Sheet steel, stainless steel, can be painted according to the customer's specifications
Profiles	15 mm x 15 mm up to 200 mm x 60 mm



### What you require

- » Clear laying of cables for easy cleaning and ventilation
- » Safe, very strong, corrosion-resistant and easy to install
- » UL and DNV GL approval for offshore use

### Our product solutions

- » Easily managed cable placement
- » Safe, very strong and corrosion-resistant construction
- » Easy to cut and shape, installed using very few tools and connectors
- » Easy to clean, well ventilated
- » Customised cable routing without accessory fittings
- » Various cover variants for (increased) protection from mechanical damage and dripping liquids
- » A wide range of Wire-tray Trunking cross section shapes such as flat-tray or special forms for vertical installation
- » Comprehensive range of fastenings
- » Machines and machine tools for processing
- » Can be designed using the 3D design tool easyRoute
- » Available as ready-to-install component assemblies

Material	Electroplated or hot-dip galvanised steel and stainless steel
Sizes	40 mm x 20 mm up to 620 mm x 110 mm

## Component assemblies service

**Your solution**  
for a fixed price:  
ready-to-install  
trunking  
layouts

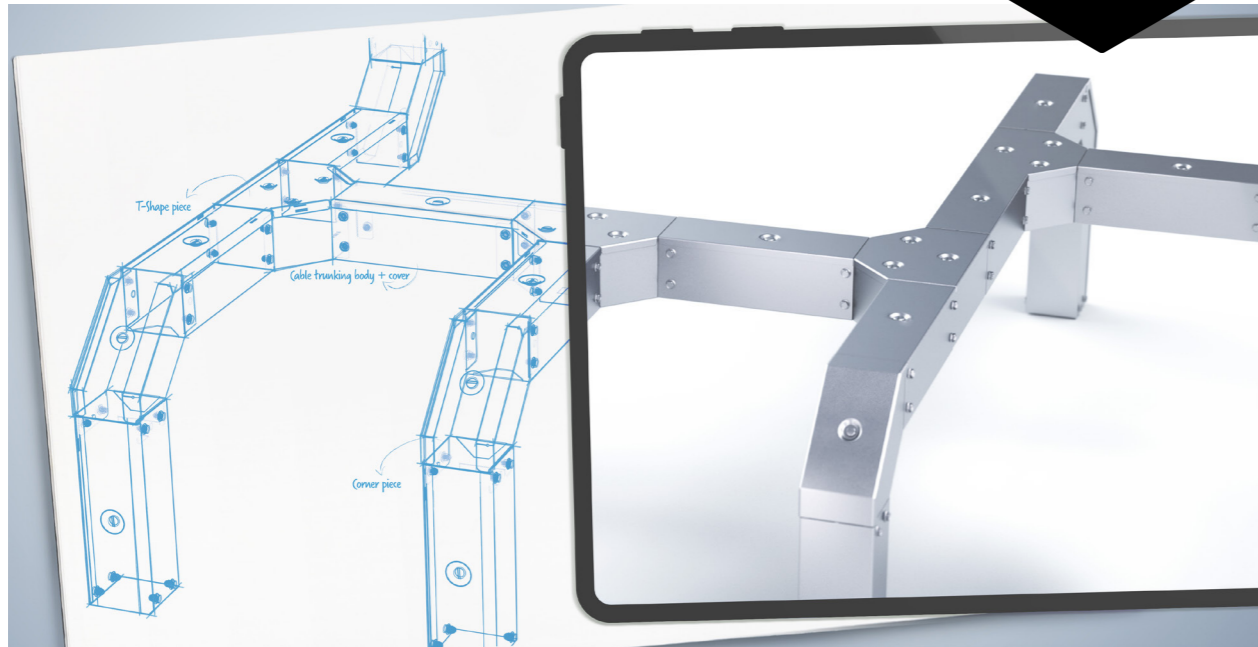

Design of component assemblies using easyRoute 3D system

## Machines and tools



**Your solution**  
for simple  
DIY cable trunking  
assembly

MultiCut for processing cable trunking



### What you require

- » Ready-to-install trunking assemblies at an affordable fixed price for dependable costing
- » Delivery on schedule, installation on-site if desired
- » Plan your routes yourself using the free 3D planning tool

### Our product solutions

- » Advice, design, pre-assembly and installation – all from under one roof
- » Component assemblies that are ready to install, delivered on time, for a fixed price
- » Customised cut-outs, mounting components or customer-specific paintwork
- » Transparent costs and potential saving up to 20% in terms of overall costs
- » The easyRoute 3D planning tool supports individual trunking routing
- » Drawings made in easyRoute can easily be integrated into the customer's CAD system



### You want to plan your individual cable trunk routing yourself?

Our planning tool easyRoute is available to you for free in our customer service portal myPFLITSCH



### What you require

- » Reliable, DIY, on-site assembly of trunking systems
- » High quality and safety during processing
- » Considerable time- and cost-saving potentials

### Our product solutions

- » Machines and tools for easy cutting of cable trunking
- » The right machine for any cable trunking:
  - › MiniCut – suitable for cutting PIK-Trunking to length
  - › MultiCut – customisable cutting plate for cutting different types of PFLITSCH cable trunking
  - › MaxiCut – perform lots of cutting operations easily, fast and reliably
- » Hydraulically and manually operated drives for efficient working
- » Reliable cutting of parts with clean and burr-free edges
- » Mobile and stationary tools for precise lateral cut-outs or for notching the side walls of wire-tray trunking
- » Less scrap and reworking
- » Rapid return on investment through time savings and an attractive price-performance ratio



**PFLITSCH GmbH & Co. KG**

Ernst-Pflitsch-Straße 1 · 42499 Hückeswagen · Germany

T +49 2192 911-0 · [info@pflitsch.de](mailto:info@pflitsch.de) · [www.pflitsch.de](http://www.pflitsch.de)

Subject to technical modifications without notice. Errors excepted.

Some of the product names used in this brochure are registered trademarks. You can find an overview of the trademarks owned by PFLITSCH GmbH & Co. KG and that apply at least within Germany at [www.pflitsch.de/en/imprint](http://www.pflitsch.de/en/imprint).

All previous and older versions shall cease to be valid upon publication of this brochure. We invite anyone interested in our products to contact us. Should you do so via the communication channels cited in this brochure and on our website, such as our telephone number or e-mail address, we ask you to take note of our declaration on data protection under the header "Privacy Policy" on our website [www.pflitsch.de/en](http://www.pflitsch.de/en).

Product overview GB | 07.2022 | 123021 | 123024+