



MANUTHIERS

L'INJECTION PLASTIQUE DE DEMAIN

Présentation de notre Société



→ **Une entreprise Familiale depuis 3 générations**

100 Salariés – 12,5 M€ de CA

+ de 60 ans d'injection plastique

700 T de matières transformées par an

→ **Un Bureau d'étude intégré**

composé de 5 chargés de projet pour vous accompagner

→ **Un Atelier interne pour vos moules et automatismes**

→ **Un Atelier composé de 42 presses de 6T à 485T**

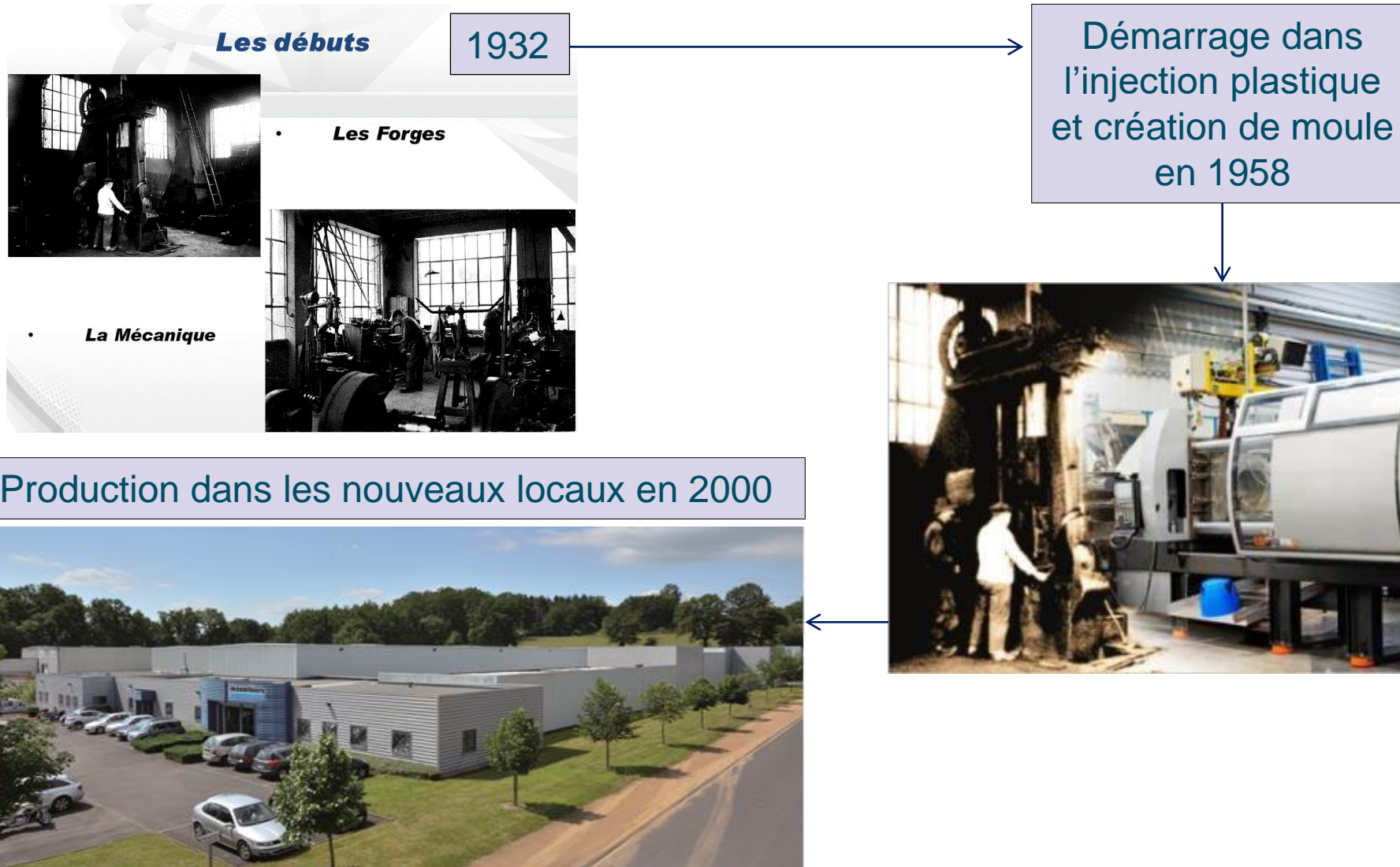

Bureau d'Etude intégré

Accompagnement de projet

Conception 2D/3D

Rhéologie

Calcul mécanique en soustraitance

Solid Works – Space – Claim –
Top Solid – Top Mold – Mold
Flow

Moules & Automatismes

Atelier interne (10 personnes)
en 2 x 8h

Panels d'outilleurs qualifiés en
France, Europe & Asie

± 100 moules par an

Service Automatismes

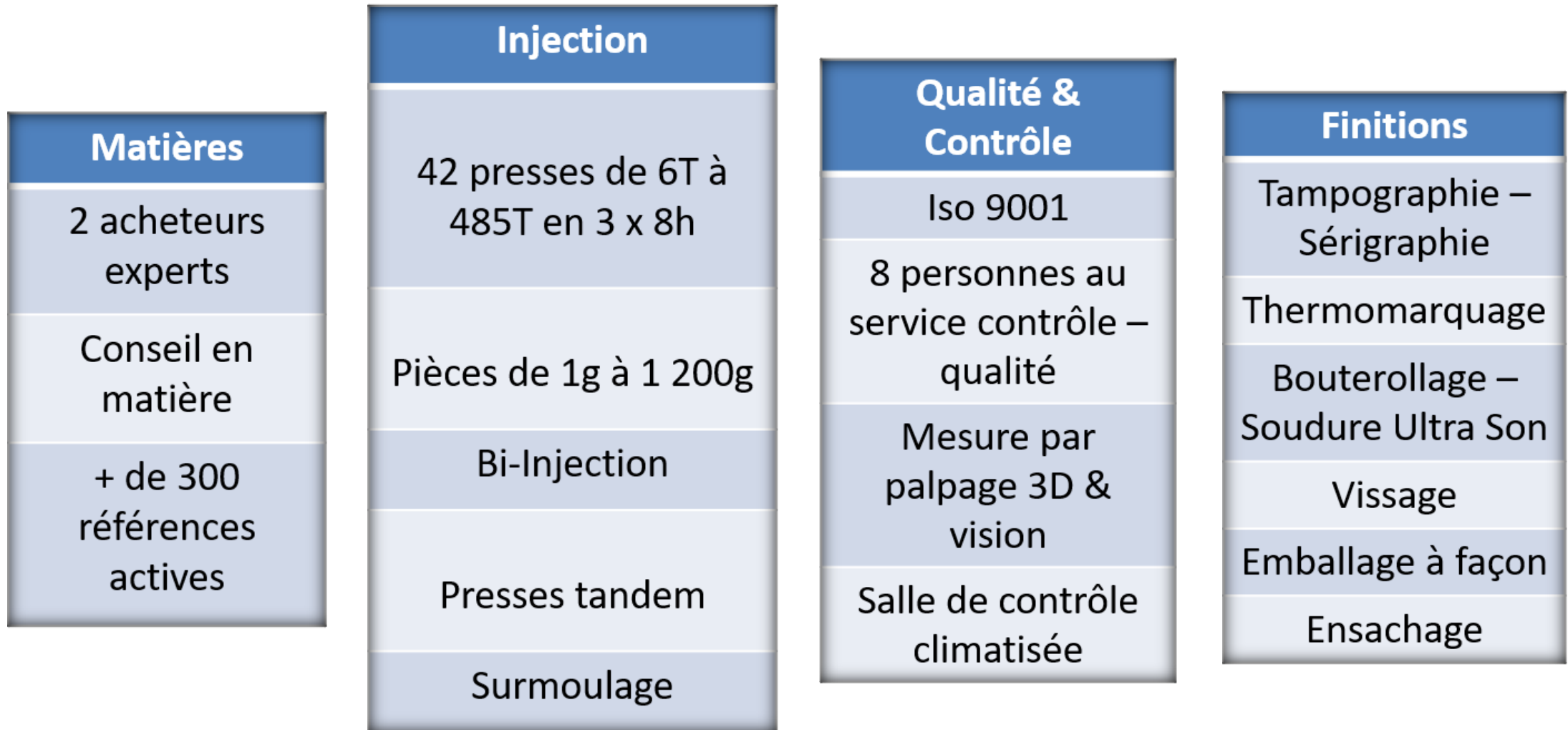

Le Savoir-Faire Manuthiers

L'accompagnement de vos projets

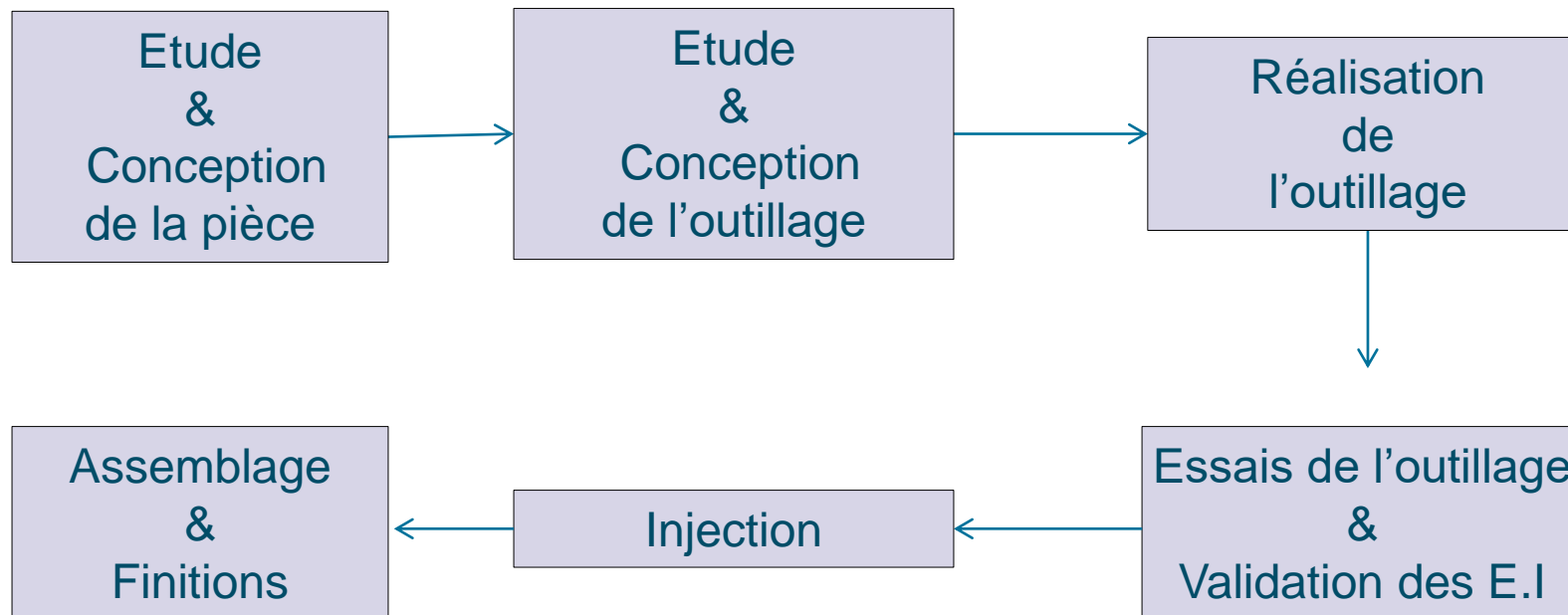

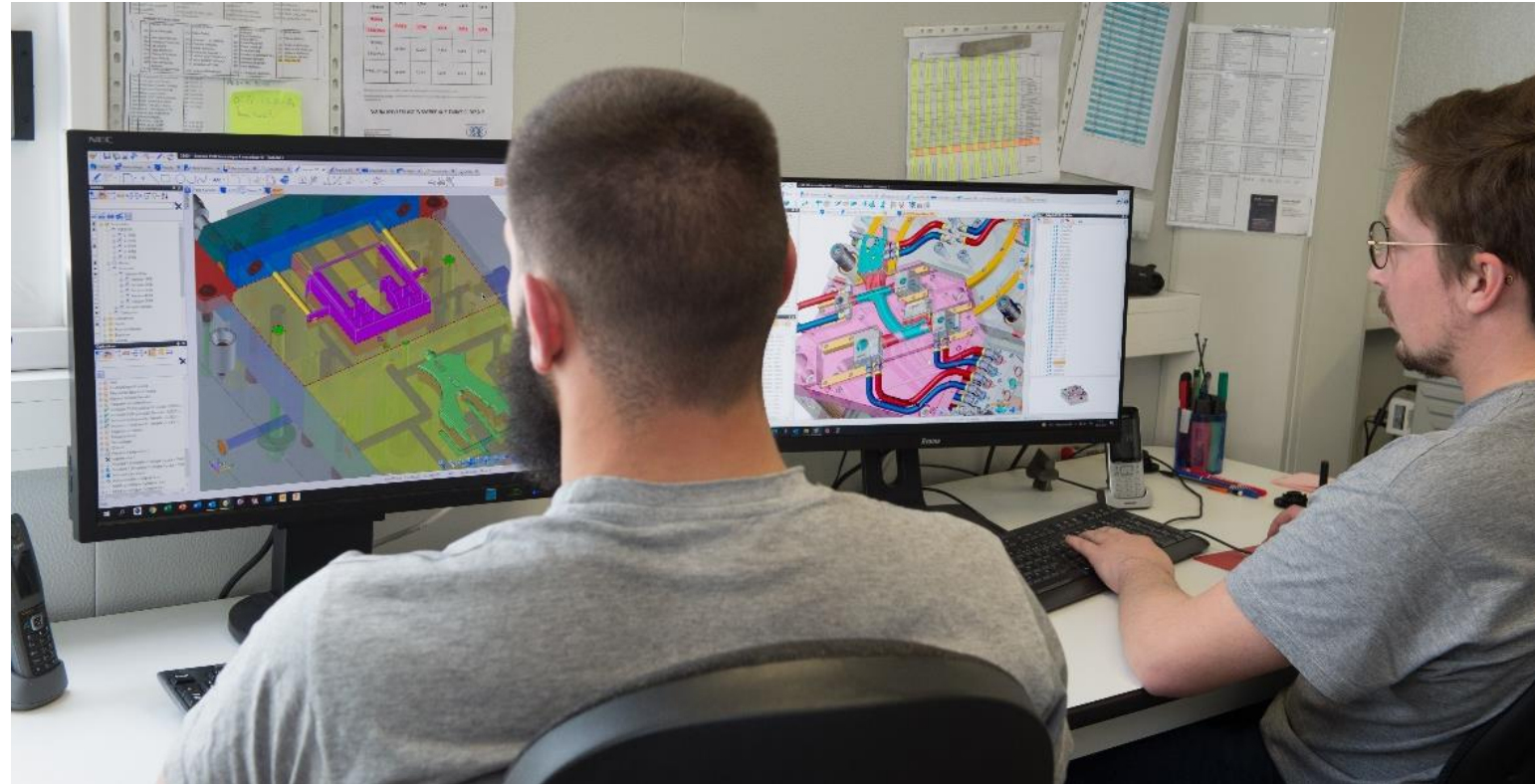
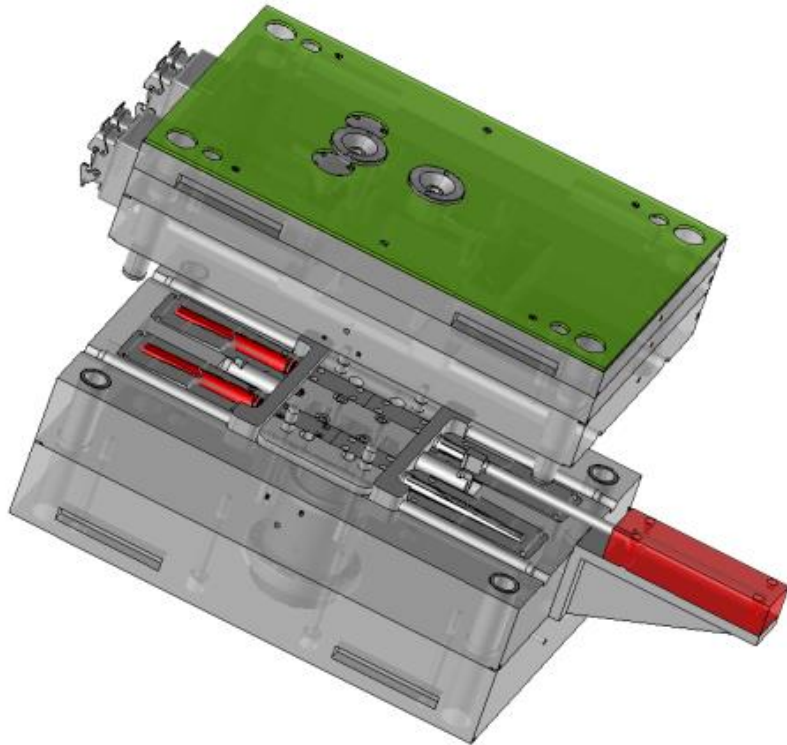

Atelier Mécanique intégré



Soudure Laser



4 centres d'usinage 3 axes



Electro-érosion à fil

Monomatiere



Bimatière



Surmoulage Multimatière



Parc Machine 2 300 m² : 42 presses à injecter



Mesure par Vision et palpage



Salle de Mesure Climatisée

Cellule robotisée pour distribution d'inserts



Process automatisé de distribution et assemblage



Assemblage et test



- Assemblage
- Ensachage
- Tampographie
- Sérigraphie
- Emballage spécifique
- Etc...

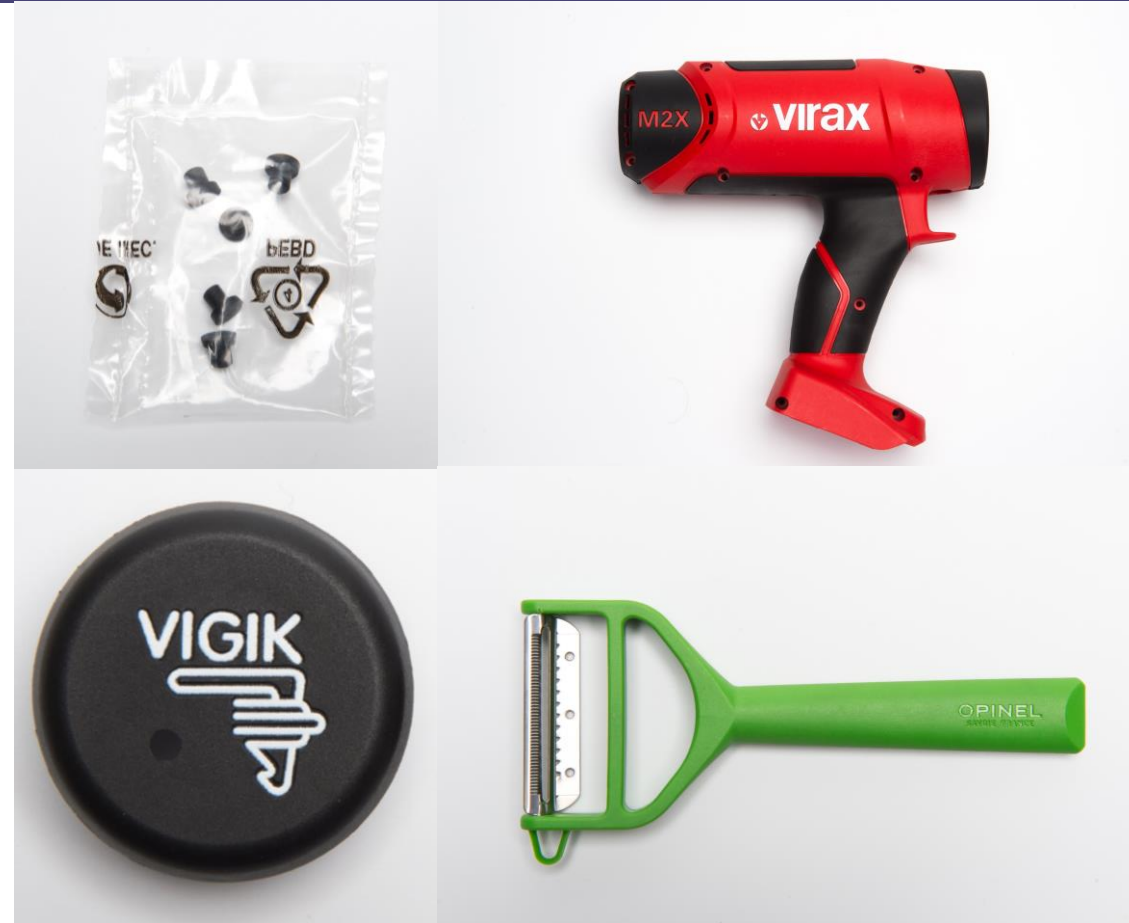

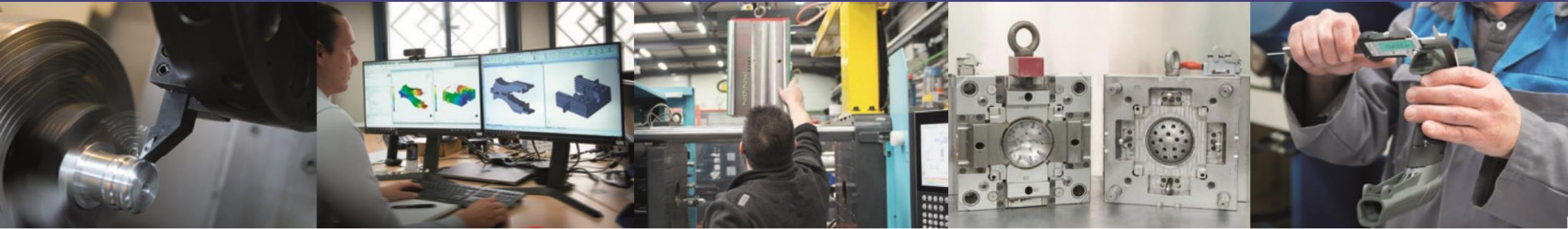

Merci pour votre attention

Marie-Eolya NOVERT
Assistante Commerciale
assistante.commerciale@manuthiers.fr

06 07 91 20 35

04 73 53 75 38