

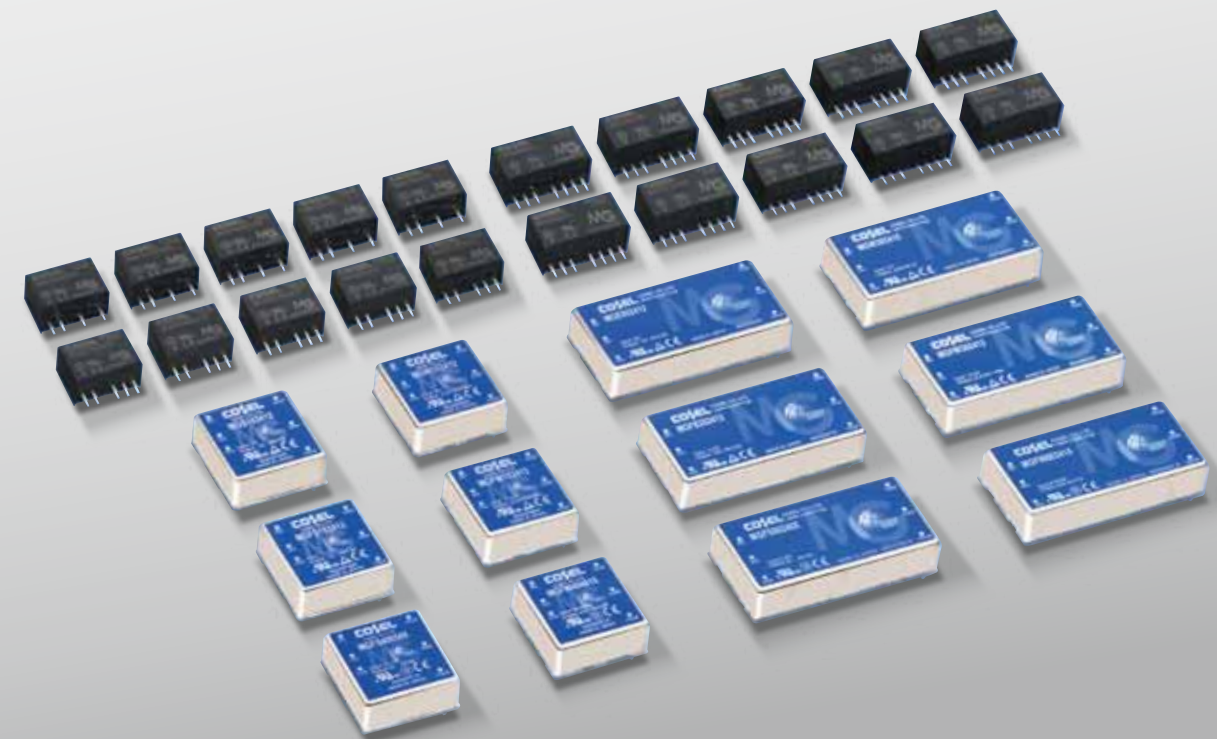

Compact Size Isolated DC-DC Converter



MG series	Model	Input voltage				Output Voltage/Current						Case Size (W×H×D) mm	
						3.3V	5V	12V	15V	±5V (10V)	±12V (24V)		±15V (30V)
	MGS1R5 MGW1R5	4.5-9V	9-18V	18-36V	36-76V	0.4A	0.3A	0.13A	0.1A	—	0.065A	0.05A	17×12×8.5 SIP6
	MGFS1R5 MGFW1R5	—	9-36V	18-76V									
	MGXS1R5 MGXW1R5 NEW	6-60V											
	MGS3 MGW3	4.5-9V	9-18V	18-36V	36-76V	0.8A	0.6A	0.25A	0.2A	—	0.13A	0.1A	17×12×8.5 SIP6
	MGFS3 MGFW3	—	9-36V	18-76V									
	MGXS3 MGXW3 NEW	6-60V											
	MGS6 MGW6	4.5-9V	9-18V	18-36V	36-76V	1.6A	1.2A	0.5A	0.4A	—	0.25A	0.2A	22×12×9.5 SIP8
	MGFS6 MGFW6	—	9-36V	18-76V									
	MGXS6 MGXW6 NEW	6-60V											
	MGS10 MGW10	4.5-9V	9-18V	18-36V	36-76V	2.6A	2A	0.9A	0.7A	—	0.42A	0.34A	22×12×9.5 SIP8
	MGFS10 MGFW10	—	9-36V	18-76V									
	MGXS10 MGXW10 NEW	6-60V											
	MGS15 MGW15	—	9-18V	18-36V	36-76V	4A	3A	1.3A	1A	1.5A	0.65A	0.5A	25.4×9.9×25.4 1×1 inch
	MGFS15 MGFW15	—	9-36V	18-76V									
	MGXS15 MGXW15 NEW	6-60V											
	MGS30 MGW30	—	9-18V	18-36V	36-76V	8A	6A	2.5A	2A	2.5A	1.25A	1A	25.4×9.9×50.8 1×2 inch
	MGFS30 MGFW30	—	9-36V	18-76V									
	MGXS30 MGXW30 NEW	6-60V											
	MGS40 MGW40	4.5-13V	—	—	—	8A	6A	2.5A	2A	—	1.3A	1A	25.4×9.9×25.4 1×1 inch
	MGFS40 MGFW40	—	9-36V	18-76V									
	MGXS40 MGXW40 NEW	6-60V											
	MGS80 MGW80	—	9-36V	18-76V	—	18A	16A	6.7A	5.4A	—	3.4A	2.7A	25.4×9.9×50.8 1×2 inch
	MGFS80 MGFW80	—	9-36V	18-76V									
	MGXS80 MGXW80 NEW	6-60V											

SIP6



Pin	Single	Dual
1	-Vin	
2	+Vin	
4	+Vout	
5	No Pin	COM
6		-Vout

SIP8

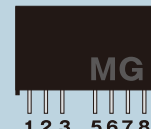

Pin	Single	Dual
1	-Vin	
2	+Vin	
3	RC	
5	NC	
6	+Vout	
7	-Vout	COM
8	NC	-Vout

1×1 inch

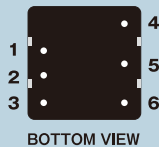

Pin	Single	Dual
1	+Vin	
2	-Vin	
3	RC	
4	+Vout	
5	TRM	COM
6		-Vout

1×2 inch



Pin	Single	Dual
1	+Vin	
2	-Vin	
3	RC	
4	+Vout	
5	-Vout	COM
6	TRM	-Vout

1.5/3/6/10/15/30/40/80W

NEW

Head Office COSEL CO., LTD.

1-6-43 Kamiakae-machi, Toyama 930-0816, Japan [Phone](tel:+81-76-432-8152) +81-76-432-8152 [E-mail](mailto:sales@cosel.co.jp) sales@cosel.co.jp [URL](https://en.cosel.co.jp) https://en.cosel.co.jp

Worldwide Sales/Support Network

(AMERICA)

COSEL U.S.A., INC.

[Phone](tel:+1-800-888-3526) (Free) +1-800-888-3526

[E-mail](mailto:sales@coselusa.com) sales@coselusa.com

[URL](http://www.coselusa.com) http://www.coselusa.com

《Engineering and Technical Support》

[Phone](tel:+1-866-921-0968) (Free) +1-866-921-0968

[E-mail](mailto:techsupport@coselusa.com) techsupport@coselusa.com

(EUROPE)

COSEL EUROPE GmbH

[Phone](tel:+49-69-95-00-79-0) +49-69-95 00 79-0

[E-mail](mailto:sales@coselurope.eu) sales@coselurope.eu

[URL](http://www.coselurope.eu) http://www.coselurope.eu

《Engineering and Technical Support》

[E-mail](mailto:techsupport@coselurope.eu) techsupport@coselurope.eu

(ASIA)

COSEL ASIA LTD.

[Phone](tel:+852-2305-2712) +852-2305-2712

[E-mail](mailto:sales@coselasia.com) sales@coselasia.com

[URL](http://www.coselasia.com) http://www.coselasia.com

COSEL (SHANGHAI) ELECTRONICS CO., LTD.

[Phone](tel:+86-21-6440-0381) +86-21-6440-0381

[E-mail](mailto:sales@coselasia.cn) sales@coselasia.cn

[URL](http://www.coselasia.cn) http://www.coselasia.cn

MG series

NEW Adding the world's highest power 40W / 80W model in a 1x1 and 1x2 inch size

MG1R5

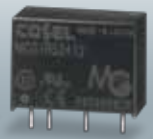

MG3



MG6

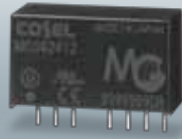

MG10

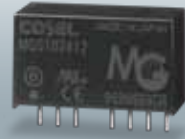

MG15

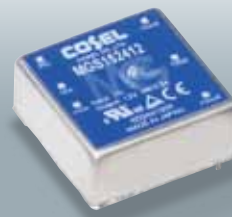

MG30



MG40 **NEW**

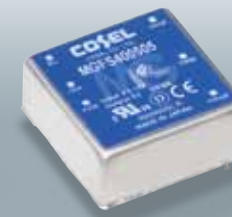

MG80 **NEW**



Feature

- ▷ Ultra Wide Input range DC6-60V (MGX□1R5/MGX□6)
- ▷ Wide Input range DC9-36V/DC18-76V (MGF□□)
- ▷ Built-in remote ON/OFF (MG□□6/MG□□10)
- [Option] -Y2: Output voltage adjustable (Excl. MG□W1R5/MG□W3)
- ▷ No electrolytic capacitor
- ▷ 10-year warranty

Feature

- ▷ Wide Input range DC9-36V/DC18-76V (MGF□□)
- ▷ DC4.5-13V (MGF□40)
- ▷ Built-in remote ON/OFF
- ▷ Output voltage adjustable
- ▷ No electrolytic capacitor
- ▷ 10-year warranty

256 Models between 1.5W and 80W

MGX Covers Wide Input Voltage Range of DC12V-48V

Ultra Wide Input MGX supplies stable voltage for large input fluctuations

1 Can use unstable input voltage, such as multiple devices connected.

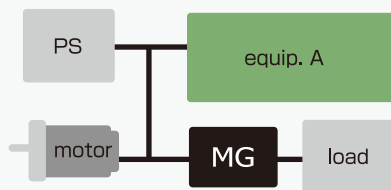

4 The same DC-DC converter can be used for different input voltage of dc12V, 24V or 48V.

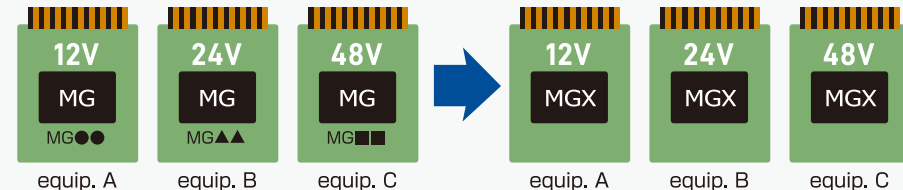

2 Protects the converter from input surge voltage by a relay ON/OFF switching.



3 Keeps the converter working at lower input voltages for data backup when instantaneous power failure occurs.

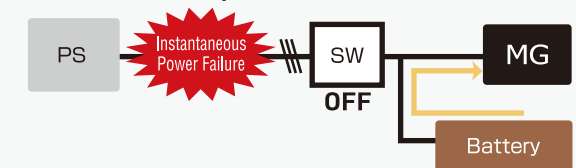

Various Input Voltage Models and Wide Input Voltage Range

Even when the application has a large input voltage fluctuation like a battery, the MGX will supply a stable voltage.

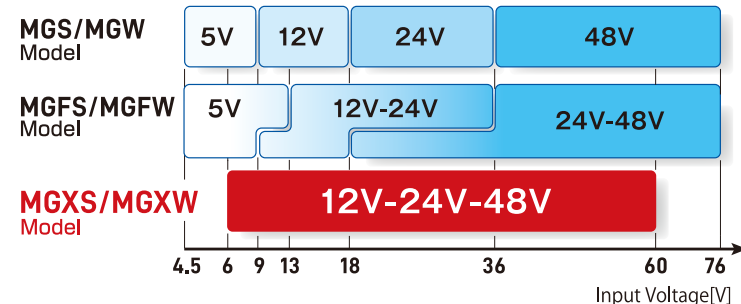

MGX is the best solution

MGF40/MGF80 Compact and High Efficiency

High Efficiency Reduces switching conversion loss with Cosel's advanced technology

Existing Technology

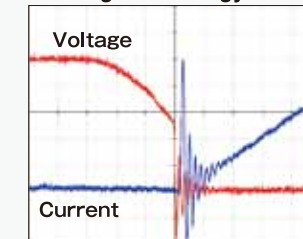

Soft Switching Technology

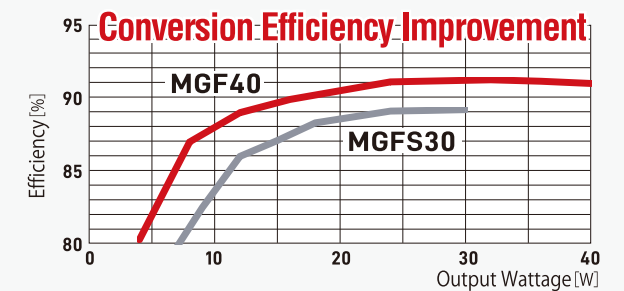
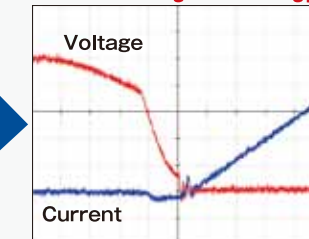

Space Saving Half volume and can be used at the same temperature

MGF30
MGFS302405



Measured by thermography (30W output)

NEW
MGF40
MGFS402405



Measured by thermography (30W output)

Compact

