

WORLD INNOVATION

DRAGO GT



WELCOME TO THE WORLD OF HIGH PERFORMANCE

olmac

olimac the Italian industry worldwide leader of corn heads.



DRAGO GT, THE NEW FRONTIER OF CORN HEADS

DragoGT, that is the result of a Great Technology developed inside a hi-tech plant, is born from an endless activity of research and trial.

WORLDWIDE UNIQUE PERFORMANCES

DragoGT is equipped with several exclusive features that have also been patented, two of which are the following:

- **automatic self-adjusting suspension deck plates**
- **double stalk chopper Scissor Effect**

Thanks to the high performances of DragoGT you will reach new productivity and harvest quality goals, consequently increasing your business profits.



OLIMAC, CONTINUOUS INNOVATION

For more than sixty years Olimac has been designing and building only corn harvesting machinery. This peculiarity is unique in the world and has allowed the company to focus on research and continuous technological innovations: the result is represented by the range of Drago corn heads which are at work in all cornfields in the world.



Increasing profits: DragoGT can harvest all corn without losing ears and kernels.



olmac

Unique in the world equipped with automatic self-adjusting suspension deck plates.

OLIMAC
WORLD
PATENT

SUSPENSION DECK PLATES

Deck plates are equipped with a special suspension device able to absorb the impact of ears on the same plates: **ears separate gentler, avoiding losing kernels among the plates**, and ears do not bounce out.
ADVANTAGES: total harvesting without losses, more productivity.

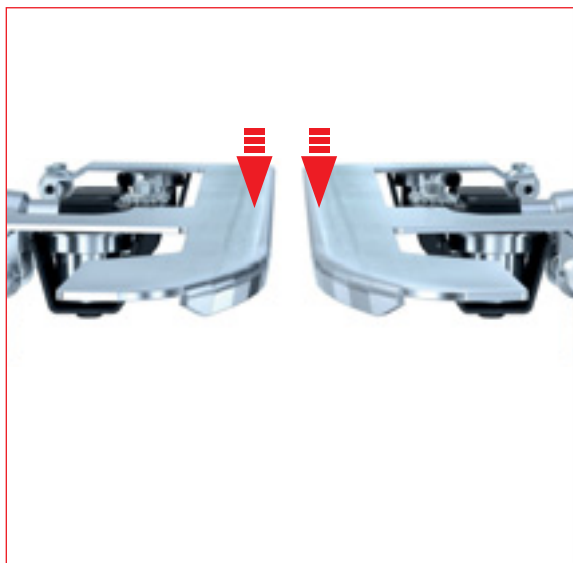

OLIMAC
WORLD
PATENT

SELF-ADJUSTING DECK PLATES

Deck plates open automatically and simultaneously according to the different size of the stalks they find on their way. **This automation works on each row independently. Operator does not need to make any adjustment.**
ADVANTAGES: total harvesting without losses, more productivity.

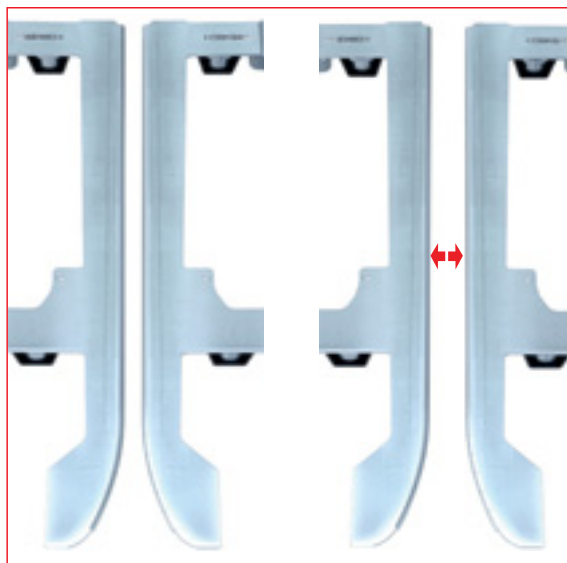

+25%

LONGER STALK ROLLERS

Stalk rollers are longer compared to normal corn heads, allowing a **lower peripheral rotation speed**, causing the **ear to separate gentler from the plant.**
ADVANTAGES: stalk perfectly pressed, total harvesting without losses.

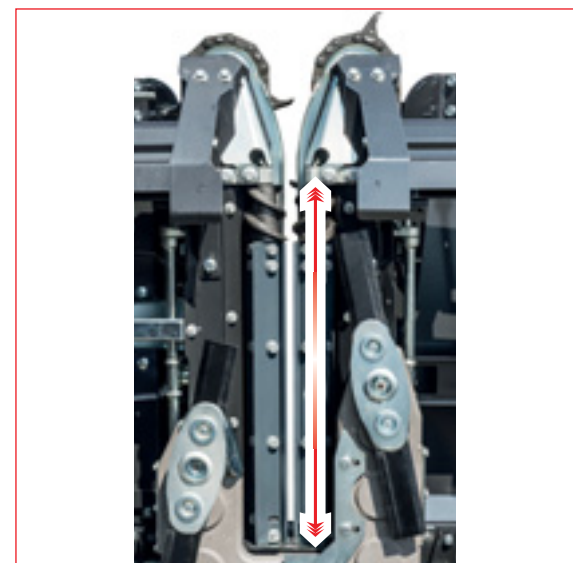

NO ADJUSTMENTS - QUICKER JOB

Operator does not need to make any adjustment so the job will result quicker, more precise and high-quality.

DRAGO
GT



Unbeatable performances. DragoGT increases your productivity while reducing your working stress.



olimac

Check the comparison with the normal corn heads.

DECK PLATES

STALK ROLLERS

**NORMAL
CORN HEADS**



**PLATES WITHOUT
SUSPENSIONS**



Ears violently hit against deck plates and forcefully separate.

**PLATES WITH
SUSPENSIONS**

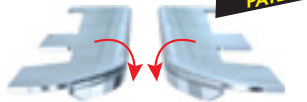

ADVANTAGES: deck plates are equipped with a special suspension device able to reduce the impact of the ears, this way separation happens gentler and there is no kernel loss nor ears bouncing out.

**NORMAL
CORN HEADS**



**FIXED
OPENING**

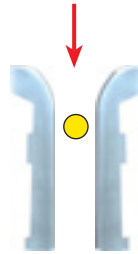
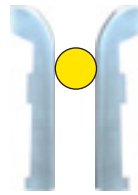

It does not change to match the different sizes of the corn stalks. It can only be adjusted by the operator, but it remains fixed while working.

**AUTOMATIC
OPENING**

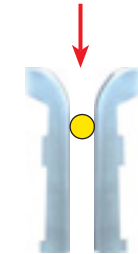
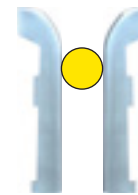

It constantly changes to match the different sizes of the corn stalks, with independent work on each row. **ADVANTAGES:** total harvesting without losses, corn stalk perfectly pressed, higher productivity.

**NORMAL
CORN HEADS**



**STANDARD
LENGTH ROLLERS**

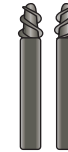

Standard peripheral rotation speed.

**LONGER
ROLLERS**

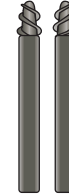

Lower peripheral rotation speed.

ADVANTAGES: gentler separation of the ear from the plant, harvesting without losses.



**NO OPERATOR'S INTERVENTION REQUIRED.
NO-STRESS WORKING.**





Higher efficiency. In extreme working conditions DragoGT can harvest all down corn.



Exclusive hyper-dimensioned auger and lower working angle.

HYPER-DIMENSIONED AUGER AND LOW PROFILE CONSTRUCTION

OLIMAC EXCLUSIVE

DragoGT is equipped with a new hyper dimensioned auger (Ø 500 mm, the biggest in the sector) allowing **higher forward speed in down and dry corn**, so to **avoid obstruction and lose of kernels**. The auger transmission is produced by an oil-bathed cylindrical gears box which does not need any maintenance. Your combine-harvester will work at the highest performance level.

Lateral augers and low profile construction allow for **total harvesting even when corn are very low-lying or hanging**.

Hyper-dimensioned auger



Oil-bathed cylindrical gears auger transmission



18° WORKING ANGLE ONLY

OLIMAC SPECIAL

In working position, the grade of the row-group toward the ground has got a much lower angle compared to many other corn heads: thanks to this feature **harvesting down corn won't be a problem anymore**.

Besides, **the low grade of the row-group avoids ears from bouncing out of the machine**.



100% QUALITY

All mechanical DragoGT components are controlled by sophisticated measuring instruments which check the correct size. This system allows reaching a higher quality together with a perfect and long lasting functionality of the corn head.

ADJUSTABLE CONNECTIONS: DRAGO GT ALWAYS WORKS AT 18°

OLIMAC SPECIAL

DragoGT can maintain its working position of 18° with any type and brand of combine-harvester, the most performing for harvesting without losses. **DragoGT's adjustable connections allow maintaining this optimum working position regardless the height of the wheels of the combine-harvester**.

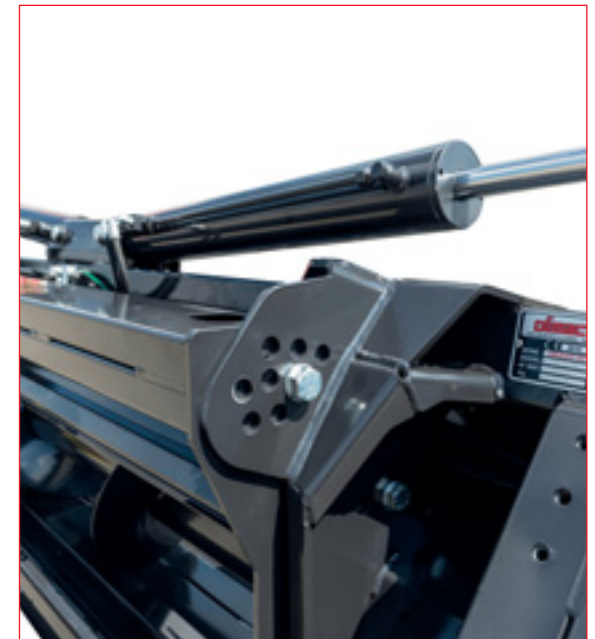



In all the corn fields of the world,
on whatever type and brand of combine-harvester.



A worldwide unique technology able to guarantee more power and robustness.

GEAR BOXES IN LIGHT ALLOY

**OLIMAC
EXCLUSIVE**

Olimac, thanks to its exclusive technology, has developed gear boxes in light alloy: **the weight of the machine is reduced while its robustness is increased**, by using cast iron where necessary. An extraordinary result only DragoGT can offer.

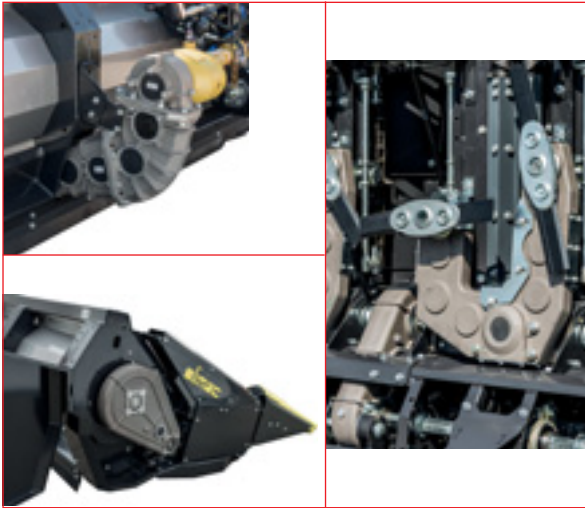

SPIRAL BEVEL GEAR PAIRS: MORE POWER AND LESS NOISE

**OLIMAC
EXCLUSIVE**

DragoGT is equipped with spiral bevel gear pairs of automotive origin, allowing for a **total power transmission** and guaranteeing a **quieter performance** compared to traditional gears used by all other brand of corn heads. These two exclusive features make your job more productive and less tiring.

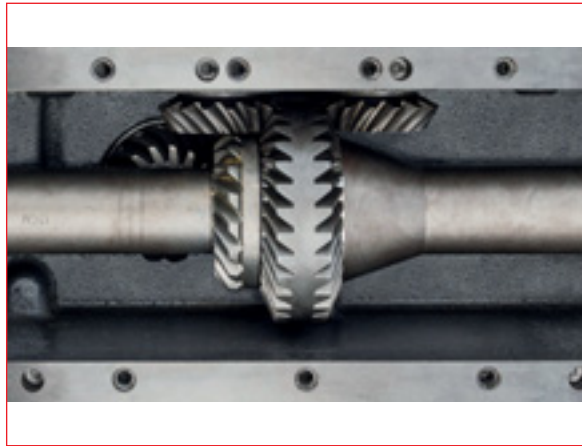

FOUR CLUTCHES FOR EACH ROW

**OLIMAC
EXCLUSIVE**

Normal corn heads have got only one clutch that intervenes in different movements. DragoGT, on the contrary, has got four clutches for each row. **These four clutches have different calibrations, each one perfectly adequate for a specific movement.** All this guaranteeing higher performances and safety.

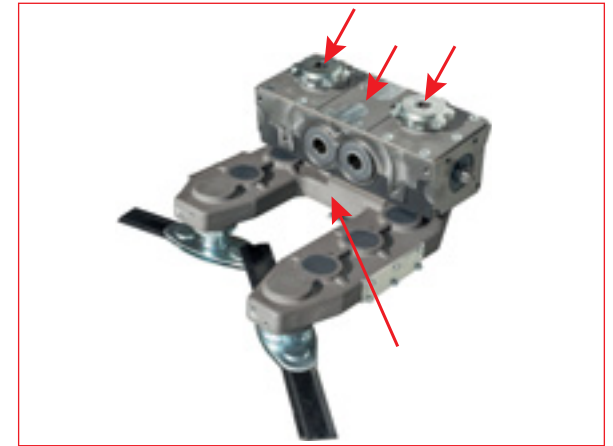

JOIN THE EXCLUSIVE DRAGO CLUB

A step up in class which allows you to carry on a more productive and profitable job, thanks to an innovative and worldwide unique technology.



olimac



Double stalk chopper *Scissor Effect*, double stalk shuttering.

OLIMAC
WORLD
PATENT

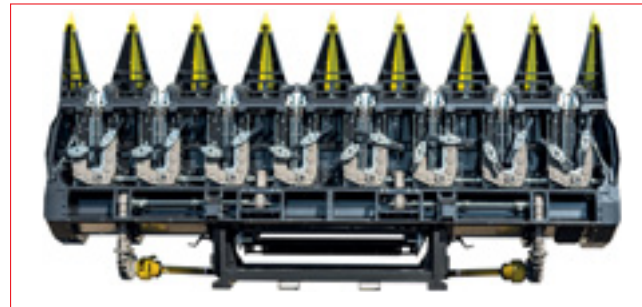
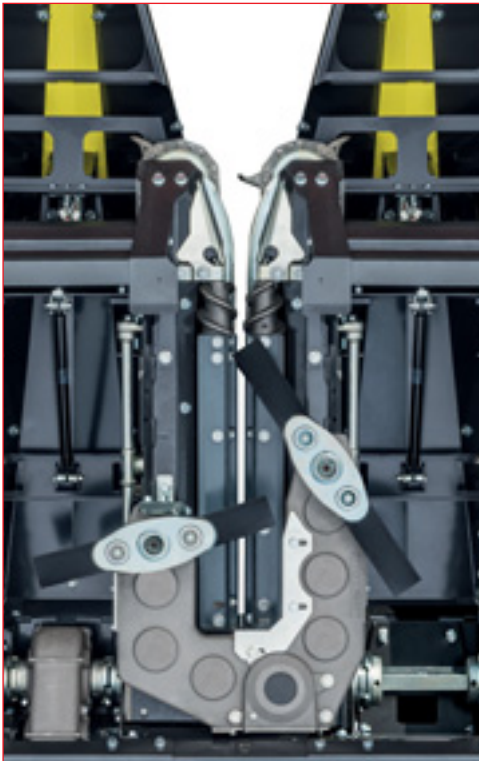

CHOPPING IS FINER COMPARED TO THE OTHER STALK CHOPPERS

Unique in the world, DragoGT is equipped with a Double Stalk Chopper ***Scissor Effect***: on each row there are four blades working. Two of them work on one side, the other on the opposite side, but with inverted rotation, **like a scissor**. Thanks to this patented device stalks are doubly shuttered and result shorter, making chopping operations finer and increasing its decomposition on soil.

LOW POWER CONSUMPTION

This Double Chopper ***Scissor Effect*** has low power consumption, equal to a single stalk chopper.

DragoGT can be equipped, upon request, with the Double Stalk Chopper *Scissor Effect* or the Single Stalk Chopper.

DRAGO
GT

Three types of transmissions, zero maintenance.

UNIQUE IN THE WORLD

INTERNAL TRANSMISSION WITH CYLINDRICAL GEARS FOR HIGH POWERS

DragoGT 6-8-10-12-16-18-24 fixed rows
DragoGT 9-10-12-16-18 foldable rows

High-performing transmission.
Zero maintenance, re-lubrication not required.
Total protection from impurities and foreign objects.



OIL-BATHED INTERNAL TRANSMISSION

DragoGT 6-8 foldable rows



High-performing transmission.
Zero maintenance, re-lubrication not required.
Total protection from impurities and foreign objects.

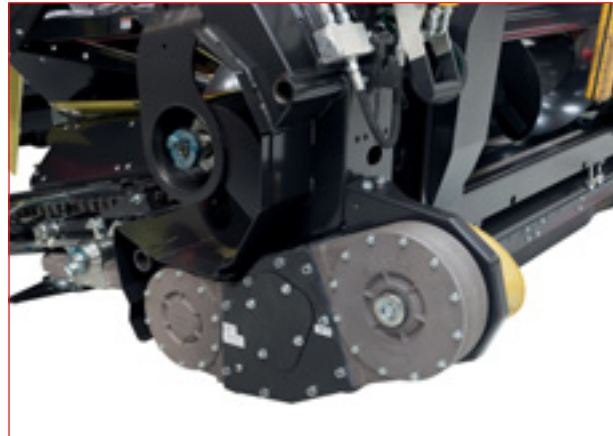

UNIQUE IN THE WORLD

EXTERNAL TRANSMISSION WITH CYLINDRICAL GEARS

DragoGT 6-8 foldable rows

High-performing transmission.
Zero maintenance, re-lubrication not required.
Total protection from impurities and foreign objects.
Ideal for hill areas.



SHEAR BOLTS

In case of exceptional overloads, the shear bolts present on the main transmission prevent the combine-harvester and corn head components to be damaged.



THREE-TIME LONG LASTING PAINTING

Olimac plant, that is totally automatic and robotic, ensures a lifetime of the painting that is three times higher than the average of the sector: excellent aesthetics and longer life of the corn head are guaranteed.



olimac

4 to 24 rows, fixed or foldable, customized according to your needs.



CORN HEAD			STALK CHOPPER	
ROWS no.	ROW SPACING cm	WEIGHT kg	SINGLE weight kg	DOUBLE weight kg
4	from 70 to 100	1.350	112	160
5	from 70 to 100	1.700	140	200
6	from 50 to 100	2.040	168	240
8	from 50 to 100	2.670	224	320
10	from 50 to 100	3.350	280	400
12	from 50 to 100	3.930	336	480
16	from 50 to 76	5.070	448	640
18	from 50 to 76	5.700	504	720
24	50	6.000	672	ND
FOLDABLE CORN HEAD			STALK CHOPPER	
ROWS no.	ROW SPACING cm	WEIGHT kg	SINGLE weight kg	DOUBLE weight kg
6	from 70 to 100	2.500	168	240
7	from 70 to 100	2.750	196	280
8	from 50 to 100	3.010	224	320
9	from 50 to 100	3.420	252	360
10	from 50 to 100	3.750	280	400
12	from 50 to 100	4.340	336	480
16	from 50 to 76	5.760	448	640
18	50	6.400	504	ND

CUSTOMIZATION - Olimac has a department dedicated to the customization of DragoGT corn heads. A team of technicians develops and fine-tunes special configurations to satisfy requests from each Customer.

'TOTAL STAINLESS STEEL' VERSION - Upon requests, you can have your DragoGT with stainless steel bonnet.

FOLDABLE FROM THE DRIVING SEAT - DragoGT can be foldable right from the driving seat. Reduced encumbrance together with total visibility make it easier to drive on the road.

SUPPORT AND ORIGINAL SPARE PARTS - A worldwide network of Olimac Authorized Service Centers assures competent support and rapid response to solve any problem. The use of original Olimac spare parts will guaranty safe operation and long life for your DragoGT corn head.



With DragoGT you will reach new productivity goals and higher harvesting quality.



BEAUTIFUL AND CLEAN PRODUCT

DragoGT can perfectly separate the ear from the stalk thanks to its exclusive features, allowing the combine-harvester to generate a more beautiful and cleaner product.



DragoGT 24 rows



DragoGT 16 foldable rows

Accessories.



Lateral and rear fall protection grid



Sunflower stalk cutting rotor



Ear stopping rubber elements

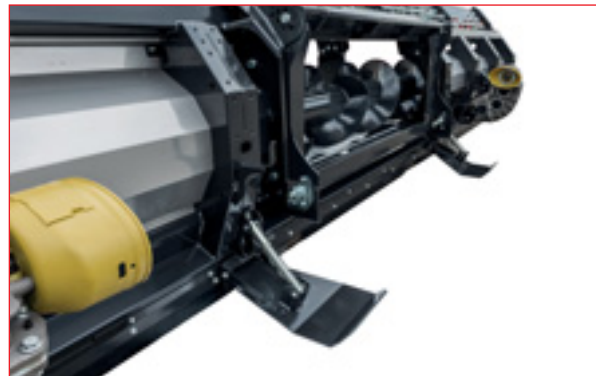

Stalk pressing kit



Auto-pilot



Levelling sensors kit



Light bar

SUNFLOWER KIT

EAR STOPPING RUBBER ELEMENTS IDEAL FOR HILL AREAS OR DIFFERENCE IN HEIGHT

STALK PRESSING KIT FOR COMBINE-HARVESTER TYRE PROTECTION

AUTO-PILOT

AUTOMATIC LEVELLING SENSORS KIT

LIGHT BAR FOR ON-ROAD TRANSPORT

A completely robotic high-tech plant. 100% quality.



A part of the production area. In the foreground, laser guided vehicles.

Completely automated painting, with coverage lasting three times longer than average in the sector.

The pieces to be painted are hooked up to special overhead rails and transported to the painting stages.

Stage 1
shot blasting

Stage 2
blowing
shot residues

Stage 3
the robots spray the
primer onto the piece

Stage 4
primer drying
oven

Stage 5
the robots spray the finishing
powder onto the piece

Stage 6
baking oven

Area
for delivery
of painted parts



OLIMAC: AN INDUSTRIAL COMPLEX UNIQUE IN THE WORLD

The new Olimac plant that covers a company-owned area of over 90,000 sqm is a completely automated industrial complex, unique in this sector worldwide. All Drago corn head parts are designed and built by Olimac in total autonomy.

The Research and Design department is the real propelling nucleus of the whole of Olimac's activity: the technology designed and all the production processes are transmitted by the IT network to the machine tools. Controls on all phases of production are thorough and ensure higher quality.

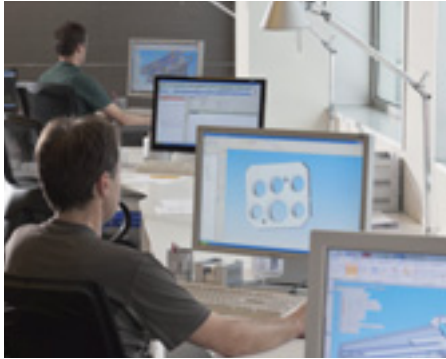

Research and Design Department



Automatic warehouse



Nine automated turning islands



Horizontal work station:
production of transmission boxes and gears

Automated laser cutting systems



Four automated welding islands



Automated gear cutting machine,
production of spiral bevel gears

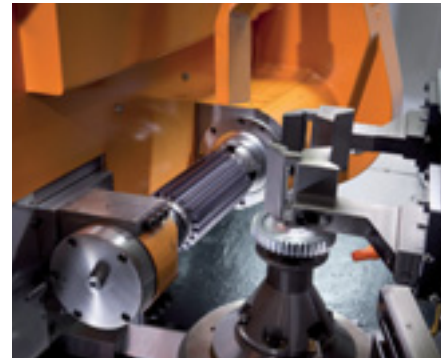

One of the painting robots



DOMOTICS

A state-of-the-art domotics system allows the coordinated, integrated and computerised management of technological systems and controls all the plant functions.



THIS INFORMATION IS GIVEN PURELY BY WAY OF EXAMPLE AND OLIMAC RESERVES THE RIGHT TO MAKE ALTERATIONS WITHOUT PRIOR NOTIFICATION

Olimac s.r.l. - Via Cuneo, 41 - 12040 Margarita (Cuneo) Italy
tel +39.0171.384898 - fax +39.0171.384904 - info@olimac.it - www.olimac.it

