

Speedrite™

DATAMARS

POWERING ADVANTAGE



2023

ELECTRIC FENCE PRODUCT AND RESOURCE GUIDE

eu.speedrite.com

A New Zealand brand



INCLUDES HAYES FENCE TOOLS

DATAMARS *Livestock*TM

We are a division of Datamars, a global company. Datamars Livestock provides the platform and tools for today's farmers to better manage their livestock.

We know that when our customers are able to collect and use data to make informed on-farm decisions, they achieve better and more consistent results. Simply, accurate livestock management translates to profitable farming.

Datamars Livestock is here for farmers just like you. We are here to support you through the everyday requirements of livestock farming. Our innovative and well-developed technology works alongside you, in the real nitty-gritty, day to day tasks.

Datamars Livestock links tools that promote animal health, enable precision animal management and improve protein production.

These tools work together, communicating with each other and communicating with you.

When you're working the land, we're there with you. On farm and online, our digital platform connects you with information about your livestock, bolstering your intuition and enabling you to make precise, informed decisions.

Datamars Livestock. Our products work with each other, but most importantly – they work with you.

Z
TAGS
DATAMARS

Simcro.
DATAMARS

njphillips.
DATAMARS

Tru-Test.
DATAMARS

Prattley
DATAMARS

Speedrite.
DATAMARS

HAYES
DATAMARS

Get in touch:

info@eu.speedrite.com

livestock.datamars.com



TABLE OF CONTENTS

Contents

New Products	6	Unigizer™ Solar Systems	24
Energizers	8	Battery Energizers	26
Choosing your Energizer	10	Portable Solar Energizers	36
Mains Energizers	12	Selecting your Energizer	42
Unigizers™	18	Management Tools	44

For more information about any of our products, visit eu.speedrite.com

Electric Fence Accessories	50	Connectors	82
Earthing, Cable & General Accessories ..	58	Insulators & Strainers	86
Posts & Reels	66	Outriggers, Standoffs & Offsets	98
Netting	72	Gate Hardware	100
Wire, Tape, Braid & Rope	76	HAYES Fence Tools	106

IMPROVED AND EXPANDED RANGE**Insulators**

For 2023 we have increased our range to encompass the largest number of solutions ever offered by Speedrite.

**SUPERIOR CONDUCTIVITY,
HIGHLY DURABLE & VISIBLE****Fence Netting**

Netting provides a quick and easy way to move your fence line whilst keeping your animals or crops protected.

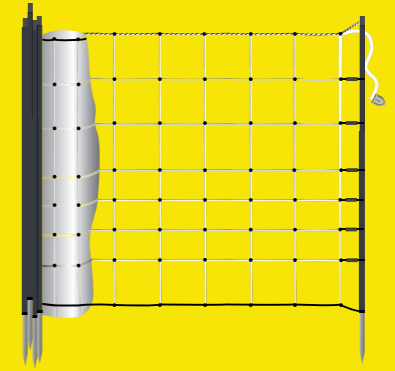
**OUR NEW****REMOTE MONITORING, IN REAL TIME****Fence Monitoring Solution**

Monitor your electric fence system with the Tru-Test Farm Network Fence Monitoring System. Allowing you to monitor voltage on different points of the fence in real time, you'll have peace of mind knowing that your livestock or crops are secure and safe.

**FLEXIBLE DESIGN, PORTABLE POWER****12V Carry Boxes**

A fully weatherproof and portable carry box which allows for a solar panel to be connected easily by a mounting kit.

**PRODUCTS****SIMPLE & POWERFUL****Value Energizers**

These 'plug and play' energizers are easy to install and operate and come in a range of models to suit your farm.

The rugged design suits all conditions and the multiple mounting options provide flexibility. These energizers get the job done!

**REIMAGINED REELS****Extreme Geared Reel**

Rugged, reliable and built for performance, the Speedrite Extreme Geared Reel reimagines everything you thought you knew about electric fence reels. Incorporating wire tracking for class leading wire management across the bobbin.



ENERGIZERS



ABOUT SPEEDRITE

As a pioneer in electric fencing, the Speedrite range has carved an international reputation for performance and durability.

Since 1938, Speedrite's proven electric fencing products have weathered the test of time in some of the harshest farming conditions.

The result of eight decades of intense research and development, you can rely on the Speedrite range of energizers and electric fencing accessories to deliver maximum power. Their unique technologies gives them a market edge, with options to suit the way you manage your farm.

With a reputation forged by over 80 years of electric fencing experience, farmers trust Speedrite to get the job done.

SPEEDRITE WARRANTY

At Speedrite, we stand behind our products so much so that we offer you the chance to extend your Energizer warranty to 7 years by registering the product on our dedicated portal.

mydevice.datamars.com

CHOOSING YOUR ENERGIZER

Speedrite offers a range of energizers to suit the way you manage your farm.

From cost effective and reliable mains energizers, to all in one Unigizers™, the Speedrite range of energizers also includes portable options and a solar range, ideal for isolated areas where no mains power is available.

ENERGIZER SELECTION

When you're buying an energizer, it's important to look at the output joules on the box.

Stored Joules relates to the energy (power) stored inside the energizer. But through a heat loss process, the energizer will output less joules than it can store.

Output Joules relates to how much energy (power) can travel from your energizer onto your fence line, powering your electric fence.

The more output joules, the more likely you will have enough voltage on your fence, even if you have faults on your fence.



Mains Range



A mains powered energizer is the most cost-effective, reliable way to power a permanent electric fence. Unigizers™ are also compatible with mains power.

Unigizer™ Range



A Unigizer™ is a flexible, all-in-one mains and battery energizer with solar compatibility. It is a versatile solution that works across permanent, semi-permanent and temporary fencing.

Battery Range



Convenient, portable and quick to set up, battery units are suitable for temporary, strip grazing and semi-permanent fencing. Unigizers™ are also compatible with battery power.

Portable Solar Energizer Range



Suitable for strip grazing, permanent, semi-permanent and temporary fencing, and the ideal solution for isolated areas where no mains power is available. Our Solar Systems and Kits provide remote power for permanent installations. Permanent installations are an all-in-one solution with built-in solar panel and battery. The Unigizer™ range is also solar compatible.

MAINS ENERGIZERS

Speedrite mains powered energizers are high performing, powerful units designed for permanent electric fence systems.

From hi-tech components and a compact, rugged design, to advanced Cyclic Wave™ and Bipolar technologies, our energizers are rugged, made for all weather conditions and have a 7 year warranty.



46000W pictured above, not available in the EU.

MAINS ENERGIZER FEATURES



7 Year Warranty*

We stand behind the reliability of our products. Visit speedrite.com for full warranty details.



Load response feature

Energizer automatically adjusts power to match the fence load e.g. high vegetation, providing maximum fence voltage for effective stock control.



Low interference

Cyclic Wave™ technology delivers outstanding fence performance and helps to minimise electromagnetic interference in line with international standards.



Large terminals

Mounted on the front of the energizer casing for convenience, these large terminals are easily adjusted and accept up to two fence wires. The slotted terminals make inserting wires and getting a good connection easy.



Compact, rugged design

Hi-tech components and advanced research and development have enabled us to make powerful energizers in a compact, rugged polymer case.



Cyclic Wave™ technology

Provides a cleaner, more powerful pulse, maximising the energy that travels down the fence for optimal stock control.



Bipolar technology

Enables the user to power a fence system to perform exceptionally well in dry, low conductive soil.



Remote capable

Using a Speedrite fence remote (with remote capable Speedrite energizers) enables you to switch the energizer on or off from anywhere along the fence line. This makes it easy to manage repairs and maintenance.



Indicator lights (voltage)

Easy to read light bar display provides an instant measure of the energizer output voltage for quick fence diagnostics. The LED display shows red when heavily loaded.



Split bolt terminal design

Allows multiple fence wires to be connected easily, with a robust connection without needing to bend the fence wire or over-tighten. (46000W only)



Datamars Livestock: Farm app

Connect to your energizer and see the fence voltage in real-time, configure your energizer settings, and connect the energizer to your Wi-Fi network. (46000W only)

*5 year standard warranty. Extend to 7 years by registering at mydevice.datamars.com

Not all mains energizers contain the features listed here. See product descriptions for more details.

MAINS ENERGIZERS

SERIOUS POWER AND CONNECTION**46000W**Powers up to
150 km / 460
acres of fence46 J maximum
output energy
(68 J
stored energy)**31000W**Powers up to
130 km / 420
acres of fence30 J maximum
output energy
(45 J
stored energy)**BLUETOOTH & WI-FI ENABLED**

- Connect to energizer using Bluetooth or set up over Wi-Fi to check voltage, turn on and off, and configure remote address (Fence remote sold separately).

SUPERIOR FEATURES

- Cyclic Wave™ provides continuous power right to the end of the fence
- LED indicators show energizer output voltage for quick diagnostics
- Bi-polar technology provides high performance in dry, low conductive soil conditions (46000W only)
- Best-in-class terminal design allows for a more robust connection of fence wires
- Can operate with 100 – 240 V mains supply

Product code: 480 0002-018 (46000W) 880 0011-025 (31000W) - ONLY AVAILABLE IN THE UK
*5 year standard warranty. Extend to 7 years by registering at mydevice.datamars.com

**7 Year
Warranty***

DATAMARS
Livestock
FARM APP
FREE*

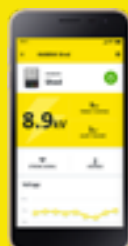
**Keep your fence performance close at hand**

Monitor and control the 46000W or 31000W mains energizer from your smartphone, with the Datamars Livestock: Farm App.

Use the Datamars Livestock: Farm mobile app to connect to your energizer and see the fence voltage in real-time, configure your energizer settings, and connect the energizer to your Wi-Fi network.

Once your energizer is connected to the internet you will be notified when your fence voltage drops, wherever you may be, so you can act quickly to resolve the issue before any animals go where they don't belong.

MOST POWERFUL EUROPEAN COMPLIANT ENERGIZER**A15Xi**Powers up to 120 km
/ 400 acres of fence15 J maximum
output energy
(21 J stored energy)**OPTIMUM EFFICIENCY**

- Output performance exceeds other energizers with similar output joules, providing a much more effective shock for animal containment or exclusion
- Automatically adjusts and delivers the power needed to provide great performance regardless of the fence condition
- New isolated power supply greatly improves the A15Xi's robustness to lightning strikes and mains surges
- Optimised Cyclic Wave™ to maximise the energy that travels down the fence for better stock control

PERFORMANCE ALERTS & INDICATORS

- Audible and visual alarm indicates when fence load suddenly increases
- Visual alert indicates when the fence is heavily loaded
- Earth monitoring function allows user to identify earth system problems
- Visual indicator shows the performance of the energizer

RELIABILITY AND FLEXIBILITY

- New large terminals ensure reliable fence connection
- Remote capable (remote sold separately), allows unit to be turned on/off from the fence

Product code: 880 0002-520 EU, 880 0002-519 UK

*5 year standard warranty. Extend to 7 years by registering at mydevice.datamars.com

**7 Year
Warranty***

	46000W	31000W	A15XI
AREA/DISTANCE YOU WANT THE ENERGIZER TO POWER	150 km 460 acres*	130 km 420 acres*	120 km 400 acres*
MAXIMUM OUTPUT ENERGY	46 J	31 J	14.2 J
MAXIMUM STORED ENERGY	68 J	45 J	21 J
NO LOAD VOLTAGE	9,500 V	9,500 V	8,200 V
MEDIUM LOAD VOLTAGE AT 500 Ω	9,300 V	9,500 V	7,100 V
HEAVY LOAD VOLTAGE AT 100 Ω	8,900 V	7,300 V	7,800 V
MINIMUM NUMBER OF 1M EARTH RODS	9	8	6
INPUT VOLTAGE	100 - 240 V	100 - 240 V	220 - 240 V

*1 hectare = 2.47 acres



MAINS ENERGIZERS

M3500



Powers up to 35 km of fence.
3.5 J maximum output energy
(6.4 J stored energy)

- Low impedance energizer
- Large enclosure
- Rugged design
- 'Plug and play' operation
- LED indicator
- Robust covered knob design
- Multiple mounting options
- 7 year warranty

Product code:
880 0010-778 EU, 880 0010-783 UK

M2000



Powers up to 20 km of fence.
2.0 J maximum output energy
(3.0 J maximum stored energy)

- Low impedance energizer
- Large enclosure
- Robust covered knob design
- Rugged design
- LED indicator
- 'Plug and play' operation
- Multiple mounting options
- 7 year warranty

Product code:
880 0010-777 EU, 880 0010-782 UK

M1200



Powers up to 12 km of fence.
1.2 J maximum output energy
(1.7 J maximum stored energy)

- Low impedance energizer
- Large enclosure
- Robust covered knob design
- Rugged design
- LED indicator
- 'Plug and play' operation
- Multiple mounting options
- 7 year warranty

Product code:
880 0010-776 EU, 880 0010-781 UK

M500



Powers up to 5 km of fence.
0.5 J maximum output energy
(0.85 J maximum stored energy)

- Low impedance energizer
- Large enclosure
- Robust covered knob design
- Rugged design
- LED indicator
- 'Plug and play' operation
- Multiple mounting options
- 7 year warranty

Product code:
880 0010-775 EU, 880 0010-780 UK

	M3500	M2000	M1200	M500
AREA/DISTANCE YOU WANT THE ENERGIZER TO POWER	35 km	20 km	12 km	5 km
MAXIMUM OUTPUT ENERGY	3.5 J	2.0 J	1.2 J	0.5 J
MAXIMUM STORED ENERGY	6.4 J	3.0 J	1.7 J	0.85 J
NO LOAD VOLTAGE	10,200 V	9,500 V	10,200 V	10,000 V
STANDARD LOAD VOLTAGE AT 500 Ω	6,200 V	5,700 V	5,500 V	4,800 V
MINIMUM NUMBER OF 1M EARTH RODS	3	3	2	1
INPUT VOLTAGE	220 - 240 V			

UNIGIZERS™

Speedrite Unigizers™ give you a versatile 3-in-1 solution to manage your electric fence system.

You have the flexibility to choose from either mains, battery or solar energy to power your electric fence.

The 3-in-1 capability allows the Unigizer™ to be used for temporary, semi-permanent, permanent and strip grazing fence systems. It's never been easier to create an electric fencing solution.



UNIGIZER FEATURES



7 Year Warranty*

We stand behind the reliability of our products. Visit speedrite.com for full warranty details.



Versatile power options

Can be used in mains, battery or solar power applications, providing convenient, versatile livestock control.



Versatile mounting options

Can be mounted on a wall, post or fence wire. Choose indoor or outdoor installation, depending on your fence location and power supply.



Earth monitoring

Indicates earth system problems by monitoring the level of voltage around the earth system.



Low interference

Cyclic Wave™ technology delivers outstanding fence performance and helps to minimise electromagnetic interference in line with international EMC standards.



Large terminals

Mounted on the front of the energizer casing for convenience, these large terminals are easily adjusted and accept up to two fence wires. The slotted terminals make inserting wires and getting a good connection easy.



Day/night sensor

Automatically adjusts to contain or exclude animals based on day or night conditions.



Cyclic Wave™ technology

Provides a cleaner, more powerful pulse, maximising the energy that travels down the fence for optimal stock control.



Bipolar technology

Enables the user to power a fence system to perform exceptionally well in dry, low conductive soil.



Low energy terminal

Limits energy to below 1.5 J for use around buildings and houses.



Solar compatible

Electrify your fence with solar power by connecting solar panels to any Speedrite Unigizer™. The solar panels charge the battery connected to the Unigizer, for reliable livestock control.



Remote capable

A Speedrite fence remote enables you to switch the energizer on or off from anywhere along the fence line. This makes it easy to manage repairs and maintenance.



12V LCD voltage display

Displays output voltage, battery voltage and earth voltage. LCD is backlit for viewing in poor light conditions. On selected models only.



Indicator lights (voltage and battery)

Easy to read light bar display provides an instant measure of the energizer output voltage for quick fence diagnostics. The LED display shows red when heavily loaded.



Battery saver

Microprocessor technology automatically adjusts the output energy depending on the battery condition. This feature extends battery life and is particularly effective when used in solar installations.

*5 year standard warranty. Extend to 7 years by registering at mydevice.datamars.com

UNIGIZERS™

HIGH POWER, LOW IMPEDANCE**15000i**

Powers up to 80 km /
225 acres of fence

15 J maximum
output energy
(20 J stored energy)

Convenient and
versatile control for
all types of livestock

**VERSATILE POWER AND MOUNTING OPTIONS**

- Can be used in mains, battery or solar power applications
- Can be mounted on a wall, post of fence wire
- Choose indoor or outdoor installation to suit your needs

LEADING CYCLIC WAVE™ TECHNOLOGY

- Cyclic Wave provides a cleaner, more powerful pulse, maximising the energy that travels down the fence for optimal stock control.
- When comparing standard energizers to Cyclic Wave energizers of the same size, the pulse of the Cyclic Wave energizer (output joules) travels further and is stronger. The efficiency of joules to wire length is also improved significantly.

OUTSTANDING DESIGN

- LED display shows output voltage
- Large terminals make connecting to the fence easy, with large terminals mounted on the front for convenience
- Low power terminal to fence around the house separately to main farm



**7 Year
Warranty***

Product code: 880 0001-338 EU, 880 0001-339 UK

UNIGIZERS™

10000

Powers up to 55 km / 150 acres of fence
10 J maximum output energy (14 J stored energy)

- Audible and visual alarm activates when fence load suddenly increases
 - Time delay feature limits energy for a period of time when fence load changes
 - Cyclic Wave® technology provides a cleaner, more powerful pulse, maximising the energy that travels down the fence for optimal stock control
 - Battery saver technology extends battery life and is particularly efficient when used in solar installations
 - Large terminals ensure good connection
 - Versatile power options – use either mains, battery* or solar* power
 - 7 year warranty.
 - Includes user manual and power adaptor.
- *Battery lead-set sold separately

Product code: 10000 - 880 0010-824 EU, 880 0010-823 UK

3000

Powers up to 30 km / 45 acres of fence
3 J maximum output energy (4.5 J stored energy)

- Solar compatible
- Indicator lights (voltage and battery)
- Day/Night sensor automatically adjusts operation
- Large terminals
- Versatile mounting and power options
- Adjustable output power and pulse speeds
- 7 year warranty
- Includes battery lead, mains power adaptor and fence lead set

Product code: 880 0001-403 EU, 880 0001-406 UK

6000/6000i

Powers up to 45 km / 90 acres of fence
6 J maximum output energy (9 J stored energy)

- Cyclic Wave technology
 - Bi-polar technology
 - Solar compatible
 - Remote capable (Remote sold separately)*
 - LCD voltage display*
 - Earth monitoring*
 - Indicator lights (voltage and battery)
 - Battery saver
 - Day/Night sensor automatically adjusts operation
 - Large terminals
 - Low Interference
 - Versatile mounting and power options
 - Half voltage terminal to fence around the house separately to main farm
 - Adjustable output power and pulse speeds
 - 7 year warranty
 - Includes battery lead and mains power adaptor
- * Additional features in the 6000i

Product code: 6000i - 880 0001-336 EU, 880 0001-337 UK

Product code: 6000 - 880 0001-334 EU, 880 0001-335 UK

2000

Powers up to 20 km / 30 acres of fence
2 J maximum output energy (2.7 J stored energy)

- Solar compatible
- Indicator lights (voltage and battery)
- Day/Night sensor automatically adjusts operation
- Large terminals
- Versatile mounting and power options
- Adjustable output power and pulse speeds
- 7 year warranty
- Includes battery lead, mains power adaptor and fence lead set

Product code: 880 0001-402 EU, 880 0001-405 UK

UNIGIZER™

1000



Powers up to 10 km / 15 acres of fence.
1 J maximum output energy (1.5 J stored energy)

- Solar compatible
- Indicator lights (voltage and battery)
- Day/Night sensor automatically adjusts operation
- Large terminals
- Versatile mounting and power options
- Adjustable output power and pulse speeds
- 7 year warranty
- Includes battery lead, mains power adaptor and fence lead set

Product code: 880 0001-401 EU, 880 0001-404 UK

500



Powers up to 5 km / 8 acres of fence.
0.5 J maximum output energy (0.7 J stored energy)

- Solar compatible
- Indicator light (pulse)
- Large terminals
- Versatile mounting and power options
- 7 year warranty
- Includes battery lead, mains power adaptor and fence lead set

Product code: 880 0001-431 EU, 880 0000-786 UK

	15000i	10000	6000i	3000	2000	1000	500
AREA/DISTANCE	80 km 225 acres	55 km 150 acres	45 km 90 acres	30 km 45 acres	20 km 30 acres	10 km 15 acres	5 km 8 acres
MAXIMUM OUTPUT ENERGY	15 J	10 J	6 J	3 J	2 J	1 J	0.5 J
MAXIMUM STORED ENERGY	20 J	14 J	9 J	4.5 J	2.7 J	1.5 J	0.7 J
NO LOAD VOLTAGE	9,800 V	9,600 V	9,500 V	11,400 V	11,000 V	9,800 V	8,300 V
MEDIUM LOAD VOLTAGE AT 500 Ω	7,500 V	7,300 V	6,700 V	6,200 V	5,900 V	5,300 V	4,400 V
MINIMUM NUMBER OF 1M EARTH RODS	6	6	4	3	3	2	1
INPUT VOLTAGE	12 V / 100 - 240 V						

SPARES

Spare Leadset Red Green Nico Variants



Product code: 880 0001-034

Battery Lead Set Unigizer Connector to Clips



Product code: 880 0000-846

UNIGIZER™ MOUNTING EXAMPLES

Sample diagrams showing Unigizer and earth system. The number of earth rods will vary, depending on the Unigizer and soil conditions.

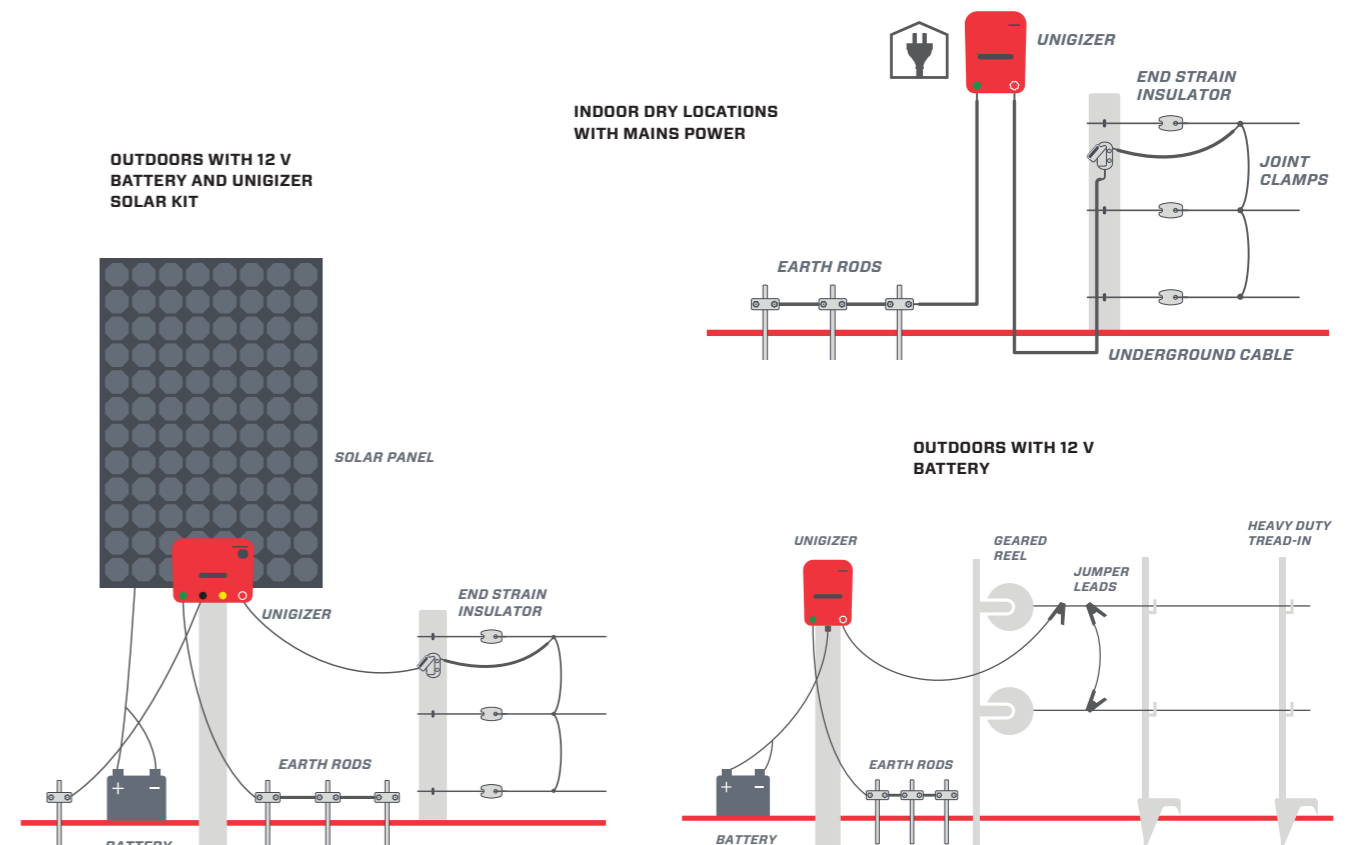

UNIGIZER™ SOLAR SYSTEMS

Speedrite offers a range of solar systems and kits for solar compatible energizers.

Innovations in technology mean solar installations are now a practical and cost effective method of powering areas where mains power is either unavailable or impractical.

Speedrite solar panels and energizers feature high-tech materials and are engineered to rigorous quality standards. This means you can trust Speedrite to transfer energy with minimal loss. The end result is less battery drain while maintaining higher fence voltage.



SOLAR SYSTEMS

Unigizer™ Solar Systems

In a solar system installation your Unigizer™ is powered by a battery which is charged by the solar panel during the day.

Based on average sunlight hours in your region and the output of our Unigizers™, your Speedrite retailer/distributor will identify the appropriate system for your needs.

Easy

Our solar systems are easy to understand, easy to select and easy to install and operate. We've done the work so you don't have to.

Reliable

Designed to ensure the fence stays running in harsh winter conditions – when you need it most.

Affordable

Excellent alternative to mains installations, providing the flexibility to power remote “off grid” sites and the security of having multiple Unigizers™ powering the farm.

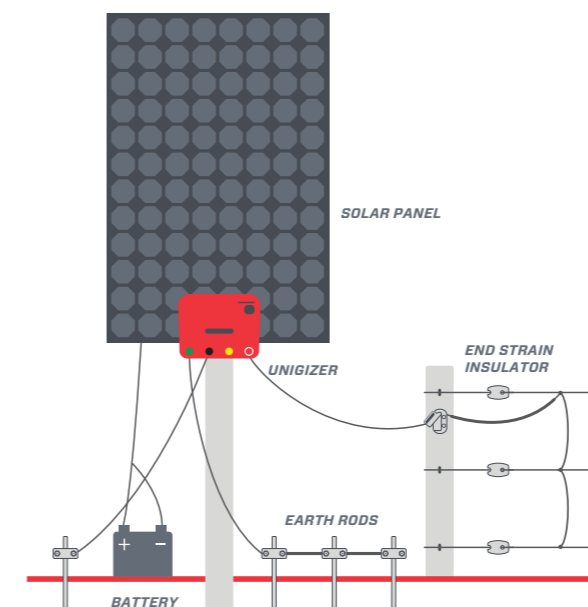

NOTE: Speedrite recommends the use of deep cycle batteries (not included).

Solar Kits

If you already own a Unigizer™, Solar Kits can be purchased separately to allow for repairs or upgrades to existing installations.

Please contact your Speedrite representative for your specific needs.

BATTERY ENERGIZERS

Speedrite battery energizers provide a portable and practical solution for strip grazing and large or small electric fence systems.

Convenient, portable and quick to set up. Unigizers™ are also compatible with battery power.



BATTERY ENERGIZER FEATURES



7 Year Warranty*

We stand behind the reliability of our products. Visit speedrite.com for full warranty details.



Compact, rugged design

Hi-tech components and advanced research and development have enabled us to make powerful energizers in a compact, rugged polymer case.



High output voltage

Intelligent output up to 9,500 V with no load.



Battery saver

Microprocessor technology automatically adjusts the output energy depending on the battery condition. This feature is designed to extend battery life.



Indicator light

Located on the rear of energizer, indicates the solar energizer is operating. (SV, B & AN ranges)



Indicator lights (voltage)

Easy to read light bar display provides an instant measure of the energizer output voltage for quick fence diagnostics. The LED display shows red when heavily loaded. (SG range)



Day/night sensor

Automatically adjusts to contain or exclude animals based on day or night conditions. (SG range & AN90)

BATTERY ENERGIZERS

PORTABILITY FOR
OUTSTANDING VALUE

SG320



Powers up to 4 km of fence
0.33 J maximum output energy
(0.43 J stored energy)

- Suitable for use on temporary fencing
- 6 position rotary switch
- Adjustable pulse speed
- Day / Night sensor
- Potted electronics
- 3-Stage light bar indicates output voltage and battery condition
- Dual power supply options: 9 volt recyclable or 12 volt rechargeable batteries
- Durable weather resistant UV resistant case
- Includes: galvanised earth stake and fence lead set
- 7 year warranty

Product code: 880 0001-244

SG220



Powers up to 3 km of fence
0.23 J maximum output energy
(0.29 J stored energy)

- Suitable for use on temporary fencing
- 6 position rotary switch
- Adjustable pulse speed
- Day / Night sensor
- Potted electronics
- 3-Stage light bar indicates output voltage and battery condition
- Dual power supply options: 9 volt recyclable or 12 volt rechargeable batteries
- Up to 0.23 J peak output energy
- Durable weather resistant UV resistant case
- Includes: galvanised earth stake and fence lead set
- 7 year warranty

Product code: 880 0001-243

SG160



Powers up to 2 km of fence
0.17 J maximum output energy
(0.22 J stored energy)

- Suitable for use on temporary fencing
- 2 position rotary switch – On/Off
- Potted electronics
- Pulse light indicator
- Dual power supply options: 9 volt recyclable or 12 volt rechargeable batteries
- Durable weather resistant UV resistant case
- Includes: galvanised earth stake and fence lead set
- 7 year warranty

Product code: 880 0001-242

B2000



Powers up to 20 km of fence
2.0 J maximum output energy
(2.7 J stored energy)

- Battery operated
- Low impedance
- Large enclosure, robust and rugged design
- Simple 'plug and play' operation for easy installation
- LED indicator
- Robust covered knob design protects user from terminals
- Multiple mounting options
- 7 year warranty

Product code: 880 0010-798

B1200



Powers up to 12 km of fence
1.2 J maximum output energy
(1.7 J stored energy)

- Battery operated
- Low impedance
- Large enclosure, robust and rugged design
- Simple 'plug and play' operation for easy installation
- LED indicator
- Robust covered knob design protects user from terminals
- Multiple mounting options
- 7 year warranty

Product code: 880 0010-797

B500



Designed to deliver power to the end of the fence even under heavy load. Powers up to 5 km (3 miles) of fence wire. 0.5 J maximum output energy (0.67 J maximum stored energy)

- Battery operated
- Battery saving mode
- Rugged design
- 'Plug and play' operation
- LED indicator
- Multiple mounting options
- Comes with fence lead set
- 7 year warranty

Product code: 880 0010-796

SV330



Powers up to 4 km of fence
0.33 J maximum output energy (0.43 J stored energy)

- Large rotary on/off switch
- Diagnostic LED light
- Battery indicator displays battery condition
- 12 volt battery saver
- Large terminals
- Dual power supply options: 9 V internal battery or 12 V external battery (sold separately)
- Durable weather and UV resistant case
- Large, ergonomic security handle
- Includes: galvanised earth stake and fence lead set
- 7 year warranty

Product code: 880 0001-901

SV170



Powers up to 2 km of fence
0.17 J maximum output energy (0.22 J stored energy)

- Large rotary on/off switch
- Diagnostic LED light
- Battery indicator displays battery condition
- 12 volt battery saver
- Large terminals
- Dual power supply options: 9 V internal battery or 12 V external battery (sold separately)
- Durable weather and UV resistant case
- Large, ergonomic security handle
- Includes: galvanised earth stake and fence lead set
- 7 year warranty

Product code: 880 0001-597

AN90



Powerful and versatile strip grazing.
Powers up to 2 km of fence
0.12 J maximum output energy (0.16 J stored energy)

- Simple set up
- On/Off switch
- Powered by 12 V external battery or 4 x D cell batteries
- Fast and slow options
- Optional tread-in stand
- Flashing LED
- 7 year warranty

Product code: 880 0000-775
880 0000-185 (with stand)

AN20



Powers up to 1 km of fence
0.04 J maximum output energy (0.05 J stored energy)

- Simple set up
- On/Off Switch
- Intelligent battery management to extend battery life
- Powered by 2 x D cell batteries
- 7 year warranty

Product code: 880 0000-329

ALKALINE VS SALINE

The benefits

ZINC BATTERIES use atmospheric oxygen to produce electrochemical energy. Since one active material lies outside of the cell, the majority of the cell's volume contains the other active component (zinc), so zinc air batteries have very high energy density. Using a reactant from the air saves on space, reducing the size and weight of the battery.

ZINC ALKALINE BATTERY

- Higher discharge current (50mA or 150Ω).
- Higher and constant voltage (8V).
- Higher energy density (350Wh/kg).
- Operating time: 2 years.

ZINC SALINE BATTERY

- Lower discharge current (25mA or 300Ω).
- Average voltage: 6V.
- Energy density (150Wh/kg).
- Operating time: 3 years (lower shelf-discharging).

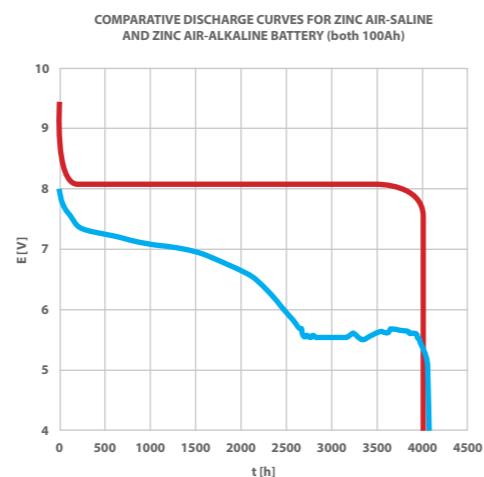

— zinc air-saline battery at 25 mA discharge — zinc air-alkaline battery at 25 mA discharge

HIGH ENERGY, OPTIMAL SIZE

9V 200Ah Alkaline Battery



FEATURES

- Higher energy density and specific energy ratio than other types of batteries: 350 Wh/kg.
- The best energy cost due to the high energy density.
- High and constant output voltage.
- Require no maintenance and no special procedures before being ready to use.
- Activated by removing label or stopper on the top of the battery.
- Safe to handle, without any risk of leakage on fixed or moving installations.
- Operating time 2 years (capacity loss for each year is just 5%).
- Can be satisfactorily used at temperatures ranging from -20°C to +45°C.
- Not subject to any special transport condition.
- Environmentally friendly as free of cadmium and mercury.

Product code: 880 0013-200

BATTERIES

9V 170Ah Alkaline Battery



Dimensions: 190mm x 127mm x 162mm

- Higher discharge current (50mA or 150Ω).
- Higher and constant voltage (8V).
- Higher energy density (350Wh/kg).
- Operating time: 2 years.

Product code: 880 0013-201

9V 130Ah Alkaline Battery



Dimensions: 165mm x 111mm x 113mm

- Higher discharge current (50mA or 150Ω).
- Higher and constant voltage (8V).
- Higher energy density (350Wh/kg).
- Operating time: 2 years.

Product code: 880 0013-202

9V 75Ah Alkaline Battery



Dimensions: 165mm x 111mm x 113mm

- Higher discharge current (50mA or 150Ω).
- Higher and constant voltage (8V).
- Higher energy density (350Wh/kg).
- Operating time: 2 years.

Product code: 880 0013-203

9V 130Ah Saline Battery



Dimensions: 190mm x 127mm x 162mm

- ZINC SALINE BATTERY
- Lower discharge current (25mA or 300Ω).
- Average voltage: 6V.
- Energy density (150Wh/kg).
- Operating time: 3 years (lower shelf-discharging).

Product code: 880 0013-204

9V 90Ah Saline Battery



Dimensions: 190mm x 127mm x 162mm

- ZINC SALINE BATTERY
- Lower discharge current (25mA or 300Ω).
- Average voltage: 6V.
- Energy density (150Wh/kg).
- Operating time: 3 years (lower shelf-discharging).

Product code: 880 0013-205

9V 55Ah Saline Battery



Dimensions: 165mm x 111mm x 113mm

- ZINC SALINE BATTERY
- Lower discharge current (25mA or 300Ω).
- Average voltage: 6V.
- Energy density (150Wh/kg).
- Operating time: 3 years (lower shelf-discharging).

Product code: 880 0013-206

BATTERY ENERGIZERS

ERGONOMIC DESIGN, PORTABLE POWER**12V Carry box**

- 12 V battery powered (not included)
- Solar powered
- Voltage indicators
- Portable design
- Adjustable modes
- Weatherproof
- Ergonomic design

**VERSATILE FEATURES**

- LED indicators show energizer output voltage from a distance
- Carry box design provides compartment for convenient installation of battery (battery not included)
- Allows for solar panel to be connected easily without needing to access the battery box (solar panel and mounting kit sold separately)
- Configurable modes adjust pulse speed for day/night conditions for maximum battery conservation
- Comes with battery leads and fence leads

OUTSTANDING DESIGN

- Conveniently located user friendly switch, display LEDs and output terminals
- Rugged case design for harsh agricultural environments
- Strong power delivery to the fence with efficient battery/solar use



7
7 Year
Warranty*

*5 year standard warranty. Extend to 7 years by registering at mydevice.datamars.com

CB2000

Powers up to 20 km of fence
2.0 J maximum output energy
(2.6 J stored energy)

- 12 V battery powered (not included)
- Solar powered
- Voltage indicators
- Portable design
- Adjustable modes
- Weatherproof
- 7 year warranty*

Product code: 880 0013-348

CB3500

Powers up to 30 km of fence
3.5 J maximum output energy
(4.6 J stored energy)

- 12 V battery powered (not included)
- Solar powered
- Voltage indicators
- Portable design
- Adjustable modes
- Weatherproof
- 7 year warranty*

Product code: 880 0013-349

CB5000

Powers up to 40 km of fence
4.8 J maximum output energy
(6.5 J stored energy)

- 12 V battery powered (not included)
- Solar powered
- Voltage indicators
- Portable design
- Adjustable modes
- Weatherproof
- 7 year warranty*

Product code: 880 0013-350

PANEL KITS

65W

- 540mm x 680mm x 25mm
- All mounting hardware included (solar panel, cables, brackets and bolts)

Product code: 880 0013-394

40W

- 650mm x 360mm x 25mm
- All mounting hardware included (solar panel, cables, brackets and bolts)

Product code: 880 0013-393

20W

- 420mm x 360mm x 25mm
- All mounting hardware included (solar panel, cables, brackets and bolts)

Product code: 880 0013-430

BATTERY ENERGIZERS

ENERGIZER	DISTANCE	MAXIMUM OUTPUT ENERGY (JOULES)	STORED ENERGY (JOULES)	NO LOAD VOLTAGE	LIGHT LOAD VOLTAGE AT 2000 Ω	MINIMUM NUMBER OF EARTH RODS	INPUT VOLTAGE
CB5000	40 km	4.8 J	6.5 J	10,500 V	9,500 V	5	12 V rechargeable battery
CB3500	30 km	3.5 J	4.6 J	10,100 V	9,200 V	4	12 V rechargeable battery
CB2000	20 km	2 J	2.6 J	10,500 V	9,000 V	2	12 V rechargeable battery
SV330	4 km	0.33 J	0.43 J	9,000 V	6,100 V	1	9 V recyclable or 12 V rechargeable battery
SG320	4 km	0.33 J	0.43 J	8,700 V	6,400 V	1	9 V recyclable or 12 V rechargeable battery
SG220	3 km	0.23 J	0.29 J	8,700V	6,100 V	1	9 V recyclable or 12 V rechargeable battery
SV170	2 km	0.17 J	0.22 J	8,400 V	5,200 V	1	9 V recyclable or 12 V rechargeable battery
SG160	2 km	0.17 J	0.22 J	8,400 V	5,600 V	1	9 V recyclable or 12 V rechargeable battery
B2000	20 kms	1.9 J	2.7 J	10,400 V	8,400 V	2	12 V external battery
B1200	12 km	1.2 J	1.7 J	10,000 V	8,100 V	2	12 V external battery
B500	5 km	0.5 J	0.67 J	8,200 V	6,600 V	1	12 V external battery
AN90	2 km	0.12 J	0.16 J	8,000 V	4,500 V	1	4 x D batteries, 12 V or 6 V battery
AN20	1 km	0.04 J	0.05 J	5,800V	2,800V	1	2 x D batteries



PORTABLE SOLAR ENERGIZERS

Speedrite portable solar energizers incorporate an internal battery and are perfect for strip grazing or powering a small area.

These self contained energizers feature an integrated solar panel and a sophisticated battery management system in a rugged carry case.



PORTABLE SOLAR ENERGIZER FEATURES



7 Year Warranty*

We stand behind the reliability of our products. Visit speedrite.com for full warranty details.



Steel and wood post mounting options

High impact enclosure is designed to securely mount on Y-posts and wood posts.



Requires minimal sunlight

Energizer requires minimal sunlight hours to keep battery at, or near, full charge.



Rechargeable internal battery

Rechargeable internal sealed battery included.



Battery recharge

Energizer intelligently manages battery recharging during fine weather.



High output voltage

Intelligent output up to 9,500 V with no load.



Rugged design

UV resistant case provides maximum weather protection for extreme environments.



Battery saver

Microprocessor technology automatically adjusts the output energy depending on the battery condition. This feature is designed to extend battery life.



Indicator light

Located on the rear of energizer, indicates the solar energizer is operating.

*5 year standard warranty. Extend to 7 years by registering at mydevice.datamars.com



SPEEDRITE PORTABLE SOLAR ENERGIZERS.

SERIOUSLY **POWERFUL**

- More voltage on the fence.

SERIOUSLY **COMPACT**

- **True portability** - smarter, more efficient electronics mean that the great performance you love is now in a more compact size.
- **Ergonomically weighted handle** - makes it more comfortable to carry.

SERIOUSLY **BETTER**

- **Simple and intuitive operation:**
 - dial and LED light clearly shows if it's on or off at a glance
 - fit and replace the battery with ease with fail-safe fit position and clear 'click' when it's locked in place
 - convenient place for storing fence leads when not in use
 - handy location for clipping the fence leads when transporting from one paddock to another
 - terminals are interchangeable, making taking terminal knobs on and off no fuss
 - terminal knob design includes a metal thread ensuring a great connection without the need for any other parts (such as washers)
 - multiple mounting configurations including Y-post, T-post and wood.



S1000 ENERGIZER

1.00 OUTPUT
JOULES

1.30 STORED
JOULES



S500 ENERGIZER

0.50 OUTPUT
JOULES

0.65 STORED
JOULES



S150 ENERGIZER

0.15 OUTPUT
JOULES

0.21 STORED
JOULES



S80 ENERGIZER

0.08 OUTPUT
JOULES

0.11 STORED
JOULES

PORTABLE SOLAR ENERGIZERS

S1000

Powers up to 10 km of fence
1.0 J maximum output energy (1.30 J stored energy)

- Requires minimal sunlight
- Indicator light (pulse)
- Battery saver
- Rugged design
- High output voltage
- Rechargeable internal battery
- Steel and wood post mounting options
- On/Off switch
- 7 year warranty
- Comes with built-in solar panel and 12 V 7 amp hour battery

Product code: 880 0002-626

S500

Powers up to 5 km of fence
0.50 J maximum output energy (0.65 J stored energy)

- Requires minimal sunlight
- Indicator light (pulse)
- Battery saver
- Rugged design
- High output voltage
- Rechargeable internal battery
- Steel and wood post mounting options
- On/Off switch
- 7 year warranty
- Comes with built-in solar panel and 12 V 7 amp hour battery

Product code: 880 0002-623

S150

Powers up to 2 km of fence
0.15 J maximum output energy (0.21 J stored energy)

- Requires minimal sunlight
- Indicator light (pulse)
- Battery saver
- Rugged design
- High output voltage
- Rechargeable internal battery
- Steel and wood post mounting options
- On/Off switch
- 7 year warranty
- Comes with built-in solar panel and 6 V 4 amp hour battery

Product code: 880 0002-604

S80

Powers up to 1 km of fence
0.08 J maximum output energy (0.11 J stored energy)

- Requires minimal sunlight
- Indicator light (pulse)
- Battery saver
- Rugged design
- High output voltage
- Rechargeable internal battery
- Steel and wood post mounting options
- On/Off switch
- 7 year warranty
- Comes with built-in solar panel and 6 V 4 amp hour battery

Product code: 880 0002-607

SPARES

Spare Battery

Valve regulated maintenance free sealed lead acid rechargeable battery.

- 12V
- 7.0Ah
- Fits the S1000 and S500 Solar Energizers

Product code: 880 0000-490

Spare Battery

Valve regulated maintenance free sealed lead acid rechargeable battery.

- 6V
- 4.0Ah
- Fits the S150 and S80 Solar Energizers

Product code: 880 0000-206

Lead Set / Cables

These (flexible, multi-stranded copper wire, insulated) leads are for connecting the energizer output terminals to the live fence wire (RED) and earth rod or wire (GREEN), respectively. They have M8 ring terminals on one end (for semi-permanent connection to energizer output terminal) and stainless steel fence/battery lead clips on the other end (for clipping onto fence wire or earth rod).

Product code: 880 0001-039

	S1000	S500	S150	S80
AREA/DISTANCE	10 km 15 acres	5 km 8 acres	2 km 3 acres	1 km
MAXIMUM OUTPUT ENERGY	1.00 J	0.50 J	0.15 J	0.08 J
MAXIMUM STORED ENERGY	1.30 J	0.65 J	0.21 J	0.11 J
NO LOAD VOLTAGE	9,600 V	9,800 V	9,300 V	7,300 V
LIGHT LOAD VOLTAGE AT 2000 Ω	7,100 V	6,200 V	4,100 V	3,200 V
STANDARD LOAD VOLTAGE AT 1000 Ω	5,600 v	4,500 v	2,600 V	2,100 V
MINIMUM NUMBER OF EARTH RODS	1	1	1	1
INPUT VOLTAGE	12 V internal battery		6 V internal battery	

SPEEDRITE ENERGIZER RANGE

Whatever distance you need to power, you'll find the right energizer for your needs in our extensive selection of products.

Your Total Electrified Distance is the total distance to electrify multiplied by the number of wires you plan to run.



7 Year Warranty*



SELECTING YOUR ENERGIZER

AREA/ DISTANCE TO POWER*	HOW WILL YOU POWER YOUR FENCE	RECOMMENDED ENERGIZER	STORED ENERGY (JOULES)	MAXIMUM OUTPUT ENERGY (JOULES)	EARTH RODS
150 km/460 acres	Mains	46000W	68 J	46 J	18
130 km/420 acres	Mains	31000W	45 J	30 J	16
120 km/400 acres	Mains	A15Xi	21 J	14.2 J	12
80 km/225 acres	Mains/Battery/Solar	15000i	20 J	15 J	6
55 km/150 acres	Mains/Battery/Solar	10000	14 J	10 J	6
45 km/90 acres	Mains/Battery/Solar	6000i/6000	9 J	6 J	4
40 km/60 acres	Battery	CB5000	6.5 J	4.8 J	5
35 km/53 acres	Mains	M3500	6.4 J	3.5 J	3
30 km/45 acres	Mains/Battery/Solar	3000	4.5 J	3 J	3
30 km/45 acres	Battery	CB3500	4.6 J	3.5 J	4
20 km/30 acres	Mains/Battery/Solar	2000	2.7 J	2 J	3
20 km/30 acres	Mains	M2000	3.0 J	2 J	2
20 km/30 acres	Battery/Solar	B2000	2.7 J	1.9 J	2
20 km/30 acres	Battery	CB2000	2.6 J	2 J	2
12 km/18 acres	Mains	M1200	1.7 J	1.2 J	2
12 km/18 acres	Battery/Solar	B1200	1.7 J	1.2 J	2
10 km/15 acres	Mains/Battery/Solar	1000	1.5 J	1 J	2
10 km/15 acres	Battery/Solar included	S1000	1.3 J	1 J	1
5 km/8 acres	Mains/Battery/Solar	500	0.7 J	0.5 J	1
5 km/8 acres	Mains	M500	0.85 J	0.5 J	1
5 km/8 acres	Battery/Solar included	S500	0.65 J	0.5 J	1
5 km/8 acres	Battery/Solar	B500	0.67 J	0.5 J	1
4 km	Battery	SG320/SV330	0.43 J	0.33 J	1
3 km	Battery	SG220	0.29 J	0.23 J	1
2 km	Battery	SV170	0.22 J	0.17 J	1
2 km	Battery/Solar included	S150	0.21 J	0.15 J	1
2 km	Battery	AN90	0.16 J	0.12 J	1
1 km	Battery/Solar included	S80	0.11 J	0.08 J	1
1 km	Battery	AN20	0.05 J	0.04 J	1

*Multi-wire fence distance (ideal)

MANAGEMENT TOOLS



MEASURE AND MONITOR YOUR FENCE

To get the maximum performance from an energizer you need to be able to measure and monitor your fence system effectively.

No matter how good an energizer is, if the fence line is badly insulated, has shorts, or is poorly earthed, it will perform well below its optimum. Advances in remote and fault-finding technology mean you can quickly locate and fix faults on your fence with a minimum of fuss.

MANAGEMENT TOOLS

Essential fence maintenance tools for accurate testing of your fence and energizer earth system.

Make fence maintenance easy with our range of testers, voltmeters and fence alerts. Durable design ensures these tools weather even the most rugged of conditions.

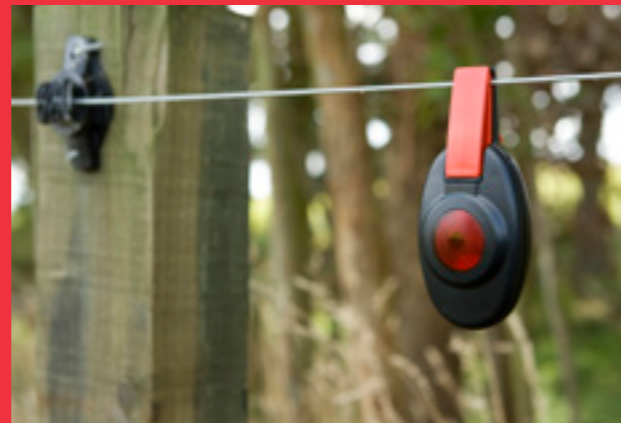

FAULT FINDING EXPLAINED

Start near the energizer's lead-out wires with your Speedrite Remote with Fault Finder or your Speedrite Fault Finder. Move down the fence line following the arrow away from the energizer. Take readings at regular intervals and at any junction point.

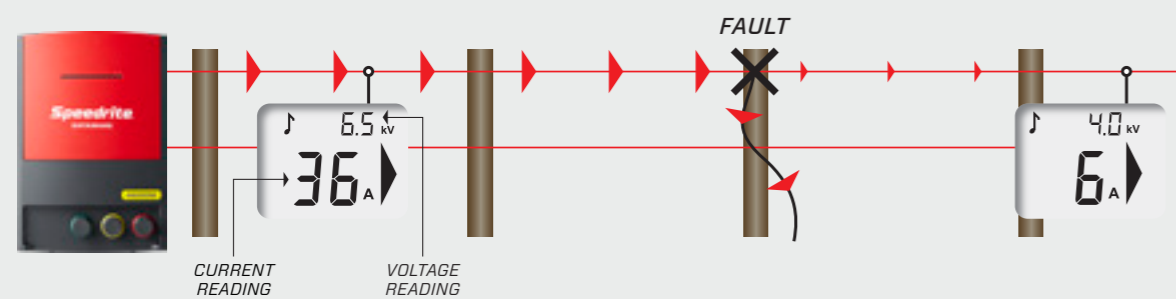

The previous current reading is shown briefly in the top right corner of the screen so that you can compare readings. If the current reading suddenly falls, you have gone past a fault. Retrace your steps to find the fault. Note that after a few seconds the previous current reading will be replaced with the present voltage reading (kV).

Watch our how-to video online: [Watch now!](#)

QUICK & EASY

Remote with Fault Finder



- Quickly and easily locates faults along the fence line
- Large back-lit display
- Displays current, voltage and current direction simultaneously
- Displays previous current reading to compare values
- Audible current indicator
- Convenient belt clip
- Insulated, rugged, water resistant case
- Replaceable 9 V battery
- Low battery warning system
- Automatic energizer polarity detection
- Fault Finding option can be used with all energizers
- Turns compatible Speedrite energizer on or off from anywhere along the fence line
- 2 year warranty*

Product code: 880 0000-860

Fault Finder



- Quickly and easily locates faults along the fence line
- Large back-lit display
- Displays current, voltage and current direction simultaneously
- Displays previous current reading to compare values
- Audible current indicator
- Convenient belt clip
- Insulated, rugged, water resistant case
- Replaceable 9 V battery
- Low battery warning system
- Automatic energizer polarity detection
- Works with all energizers
- 2 year warranty*

Product code: 880 0000-771

Digital Voltmeter



- Enables accurate testing of fence and energizer earth system
- Earth probe provides accurate fence to ground voltage measurements
- Readings from 200 V to 9,900 V in 100 V increments
- Rugged design
- Automatic On/Off
- Replaceable 9 V battery
- 2 year warranty*

Product code: 880 0001-529

Light Tester



- Handy, pocket-sized unit for testing general fence condition
- Shows if fence is live and measures approximate voltage
- Readings from 2,000 V to 6,000 V in 1,000 V increments
- Easy to read voltage markings
- No battery required
- 2 year warranty*

Product code: 880 0000-120

Fence Alert



- Warning light begins flashing when voltage is too low
- Visible up to 1.5 km away
- Rugged impact and water resistant case
- Can be used on any type of electric fence
- Works with all energizers
- No ground wires or external power sources required
- Battery life 5 years on standby or up to 2 weeks of continuous flashing
- 2 preset voltage triggers can be selected
- Replaceable battery
- 2 year warranty*

Product code: 880 0000-521

*Batteries fitted inside management tools have a 90 day warranty.

Tru-Test
DATAMARS



Fence Monitoring Solution

Monitor your electric fence system with the Tru-Test Farm Network Fence Monitoring System. Allowing you to monitor voltage on different points of the fence in real time, you'll have peace of mind knowing that your livestock or crops are secure and safe.

The Fence Monitoring System is made up of Gateways and Fence Nodes. The minimum system is 1 x Gateway and 1 x Fence node.

The Gateway provides the internet/cloud interface to the on-farm network. Each Fence Monitoring system requires one of these devices to allow information to be collected from the nodes and passed to the cloud.

The Fence Node communicates to the gateway through radio frequency and can be up to 500 m away from line of sight of the gateway. The system works like a mesh, where each node can talk to all other nodes within 500 m to relay information back to the gateway. Up to 50 fence nodes can be added.

FEATURES AND SPECIFICATIONS

- ✓ Fence Monitoring Nodes record fence voltage 24/7
- ✓ Cloud-based data storage and 24/7 access from anywhere on mobile and web
- ✓ Firmware upgrades can be programmed over the air
- ✓ Allows for 50 Fence Monitoring Nodes per system
- ✓ Install at key fence sections across your farm
- ✓ Easily extend the number of fence sections monitored by adding more nodes†
- ✓ Tough weatherproof enclosure to withstand all conditions
- ✓ Works with any energizer
- ✓ 3 year warranty

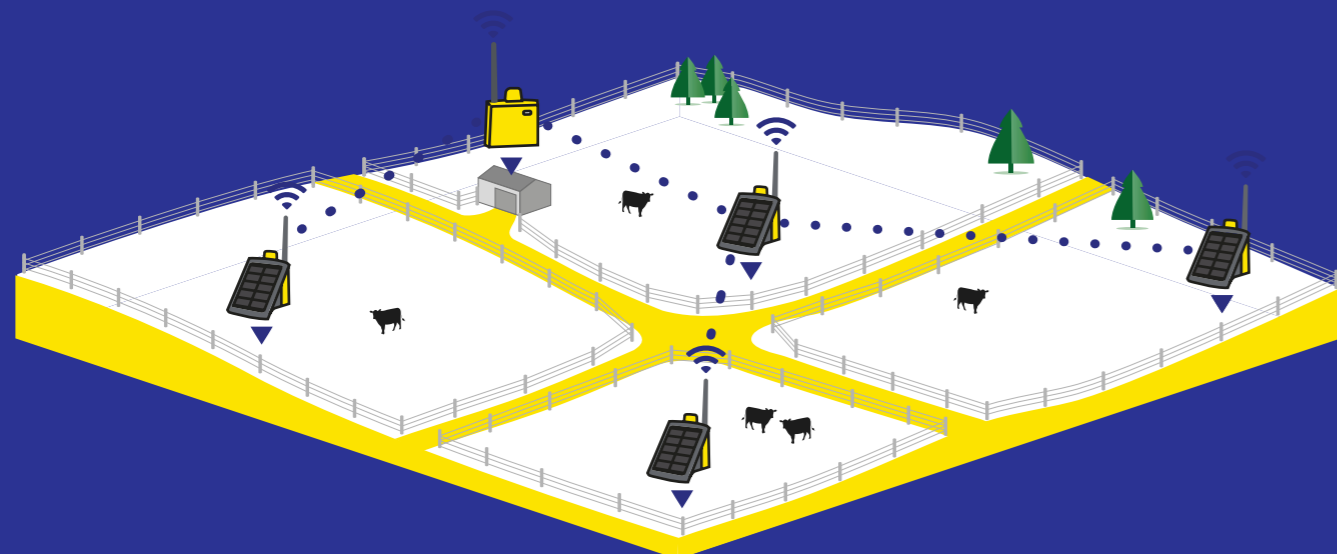

Designed to work seamlessly with Speedrite Energizers

Fence Monitoring Node FN1F 4W



- ✓ Measures up to 12,000 V
- ✓ Records a measurement every 2 minutes
- ✓ Solar panel for all year round operation - 4W
- ✓ RF communication distance to gateway/other nodes - Up to 500 m line of sight
- ✓ LEDs to indicate operation
- ✓ Can be easily mounted to wood post or steel post
- ✓ Outdoor weatherproof design
- ✓ Compatible with all premium Energizers

Fence Monitoring Gateway GW1 - Wi-Fi/Ethernet



- ✓ Collates information from Fence Monitoring Nodes
- ✓ Wi-Fi for access to the internet
- ✓ Bluetooth® Low Energy for easy setup
- ✓ Power adaptor included for continuous operation - 100 - 240 V
- ✓ Internal battery back-up for brownout conditions - 12 hours of back-up
- ✓ LEDs to indicate operation
- ✓ RF communication distance to nodes Up to 500 m line of sight
- ✓ Can be easily mounted to internal/external shed or house wall
- ✓ Outdoor weatherproof design

Product	Description	Product Code
Fence Monitoring Starter Kit 4W (FN1F 4W KIT)	<ul style="list-style-type: none"> • 3 x Fence Monitoring Node 4W (FN1F 4W) • 1 x Gateway - Wi-Fi/Ethernet (GW1) 	880 0004-542
Fence Monitoring Node 4W (FN1F 4W)	<ul style="list-style-type: none"> • For further expansion of the coverage area of the fence monitoring system, more nodes are available 	880 0004-539
Gateway - WiFi/Ethernet	<ul style="list-style-type: none"> • Single gateway, required hardware for connecting nodes to. Handles the connection to Fence Monitoring Nodes and passing of information. 	880 0004-541

ELECTRIC FENCE ACCESSORIES

PERMANENT AND TEMPORARY FENCING ACCESSORIES

Permanent fencing accessories

A flexible, durable and economical fencing solution. Easy to install and operate with less maintenance.

It is also a safe fencing solution for your livestock as it reduces animal contact with the fence and is less likely to injure should a fence be breached.

Temporary fencing accessories

Temporary electric fencing helps to increase production through providing a quick, easy and inexpensive way to subdivide paddocks.

This portable fencing solution gives you the versatility to strip graze, make temporary paddocks or pens and protect trees and crops from damage by stock.

Equine fencing accessories

Speedrite's range of equine products for use in permanent and temporary electric fencing are identified by the horse logo.



PERMANENT ELECTRIC FENCE SYSTEM

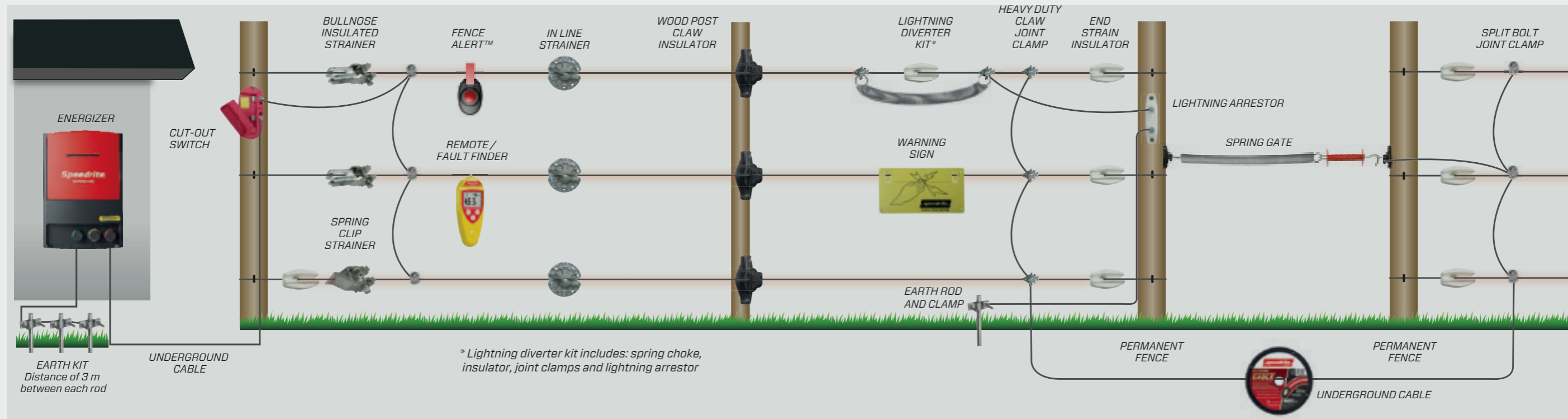

TEMPORARY ELECTRIC FENCE SYSTEM

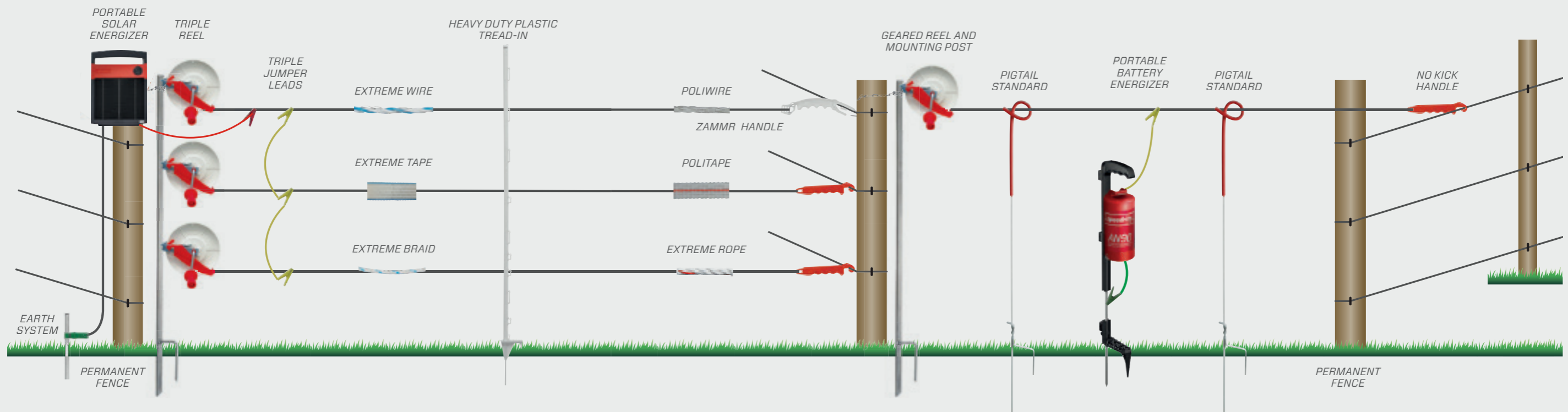

Diagram is an example only. For more details on electric fencing design visit speedrite.com/resources

EXCLUSION VS. CONTAINMENT FENCES

Traditional CONTAINMENT electric fence applications

such as those used to control cattle, horses, sheep, and goats, are primarily designed to keep these animals in a limited area. These animals are usually domesticated and are somewhat predictable. Most importantly, you are fencing these animals IN with their food source.

Standard EXCLUSION fences

such as those designed to keep out bears, wolves, coyotes, deer, or feral hogs – are different from traditional electric fence applications. These animals are not domesticated, are highly unpredictable, and can be extremely dangerous. Most importantly, you are fencing these animals OUT of their food source. Electric fence is a terrific and an effective solution for EXCLUSION fences, but it is absolutely critical that you do it right – for you, your property, and the animals.

Exclusion fences for small nuisance animals are primarily designed to keep them out of small flower gardens, landscaped areas, and other similar areas around a house or business. Usually, a single wire fence placed 100 - 150 mm off of the ground will be sufficient. Make sure the wire is not too close that it actually touches the ground itself. In some cases, you may need to add a 2nd or 3rd wire (allow 100 - 200 mm vertical distance between each wire).

Containment fences for dogs are primarily designed to keep them in a residential yard. Usually, a single electrified wire placed 100 - 150 mm above the ground will be sufficient as most dogs will try to dig under the existing permanent fence. Make sure the wire is not too close that it actually touches the ground itself. If you want to add a 2nd or 3rd wire, allow 100 - 200 mm vertical distance between each wire.

Here are some basic guidelines for Standard Exclusion fences

Best practice

- Use an energizer with a MINIMUM of 0.5 OUTPUT joules (NOT stored joules). Wildlife agencies recognize 0.5 output joules as the minimum output energy required to control predators.
- Research the type of fence design and conductor wire required for your specific application.
- Use proper earthing and fence construction techniques when building the electric fence. Both of these elements are crucial to the success of the fence.
- Solicit sound, professional advice before starting any project.

Avoid

- Using inferior products. This is NOT the time to go cheap on your energizer, fence materials, and earthing system.
- Annoying the animal by using small energizers. The energizer must deliver a powerful enough shock to deter the animal. Small energizers just make the animal mad, making the animal try harder to get through the fence.
- Assuming that all conductors (wires) are good or acceptable to use when controlling predators. Certain applications are fine with poli products, while others will require heavier gauge steel or aluminum wires.

Exclusion Fences

Key considerations

- Size of the predator determines the wire spacing
- Jumping ability of the predator will determine height
- Maintain low wire spacings for predators known to dig

- As a general rule, all exclusion fences should use a hot-earthing system
- Netting can be an acceptable solution in some cases. Use "Pos/Neg" electrified netting in areas with poor earthing conditions.

Common uses

- Beehives
- Chickens
- Campsites
- Residential garbage protection

EXCLUSION FENCE EXAMPLES



5 WIRE FENCE

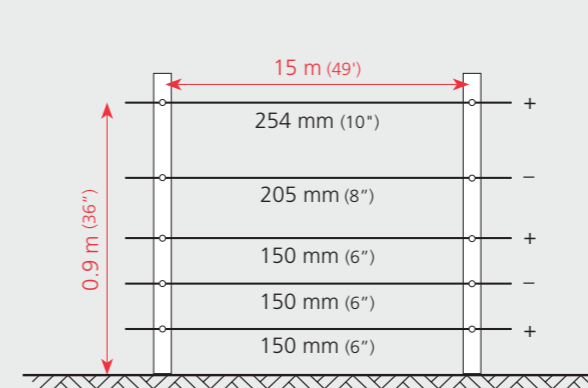

6 WIRE FENCE

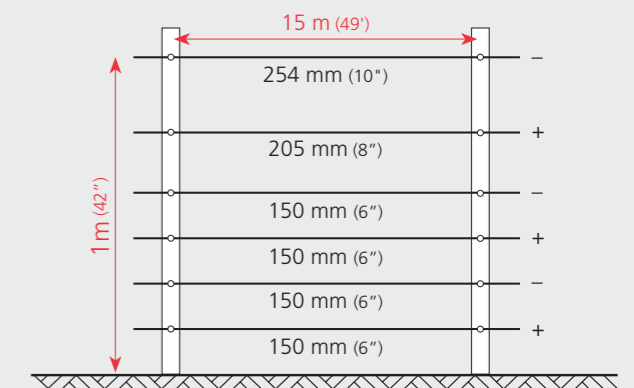

7 WIRE FENCE

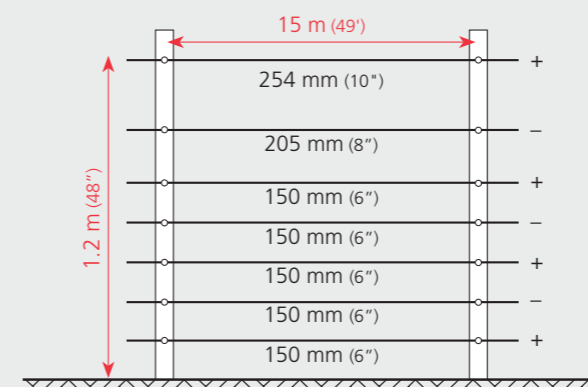

Exclusion Fences (Crop Protection)

Key considerations

The 2 fence system (i.e. inside and outside fence), with differing heights and the slant fence, achieve a 3-dimensional effect on the deer. This impairs the deer's ability to judge the height and distance they need to jump to clear the fence.

! Make sure you have enough energizer to deliver an effective shock. Most applications require a minimum of 1 output joule per 10 acres.

Common uses

- Commercial row crop protection
- Food plots
- Gardens
- Certified organic operations
- Protecting natural formations

CROP PROTECTION FENCE



FRONT VIEW

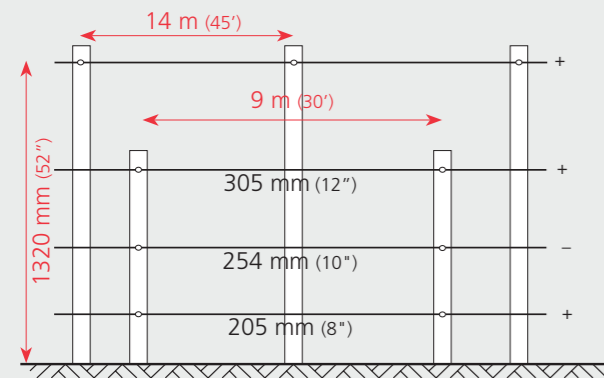

TOP VIEW

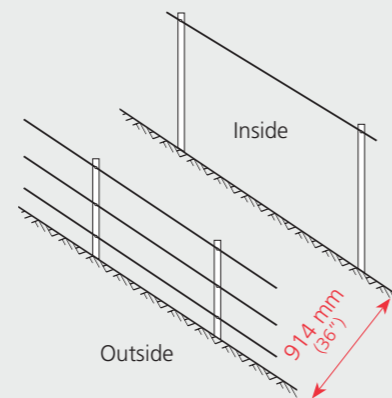

SLANT FENCE

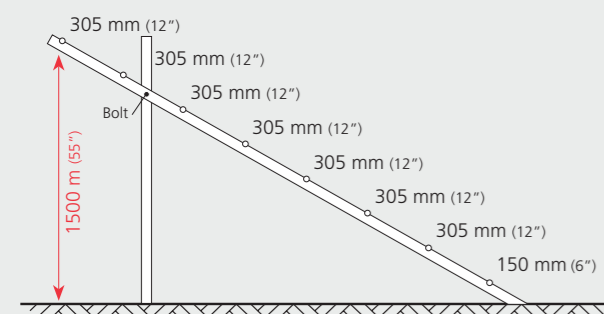

Slant fences are another form of exclusion fence that can be used to deter deer and other nuisance animals.

Containment Fences

Also recommended for pigs (not feral hogs) and other domesticated livestock.

Common uses

- Small or large pastures
- Strip Grazing/Managed Grazing
- Fencing off hay bales
- Grazing wheat or corn fields

CONTAINMENT FENCE EXAMPLES

CATTLE AND HORSES



10 m (33') spacing, posts only

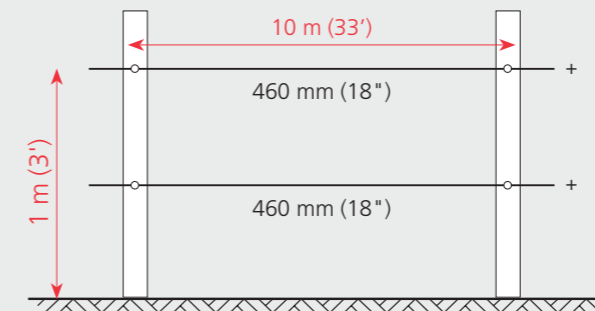

GOATS AND SHEEP



5 - 10 m (16 - 33') spacing, posts only

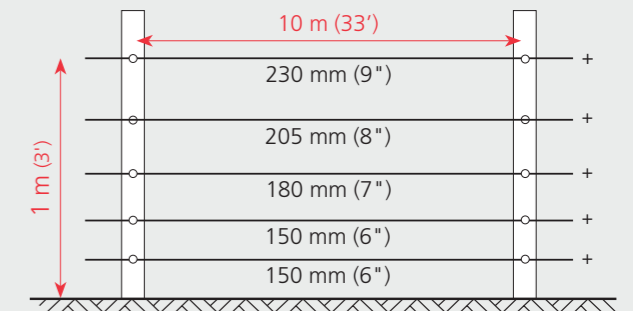

6 wire boundary or subdivision

10 m (33') spacing, posts only

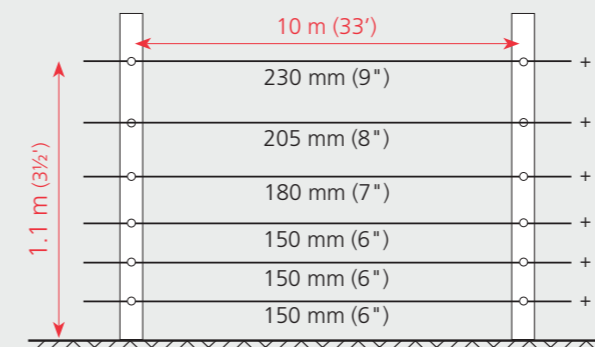

EARTHING, CABLE & GENERAL ACCESSORIES

Your earth system is the most important component of your electric fence system.

An effective earth system will optimise the performance of your fence.

All Speedrite Underground Cable is double insulated to reduce the risk of voltage leakage.



2 Year Warranty



SETTING UP YOUR EARTH SYSTEM

Installing your Energizer

Before installing make sure you have read all the instructions provided with your energizer.

Indoor installation

Mains, Unigizer™ or battery powered energizer

- Mount out of reach of children and animals
- Mount a mains powered energizer near a power point

Outdoor installation

Unigizer or battery powered energizer

- Mount out of reach of children and animals
- If necessary, build a protective box or fence around the energizer and battery
- Where possible, connect the energizer to the middle of the fence

Solar Installation

Solar powered energizers

- Mount out of reach of children and animals
- If necessary, build a protective fence around the solar installation
- Where possible, position the energizer and solar panel(s) in the middle of the fence
- Adjust the solar panel(s) to face north in the southern hemisphere and south in the northern hemisphere
- For extended battery life, store your batteries under cover

Earthing your Energizer

Understanding earthing

What is an earth system?

The earth system consists of a number of earth rods that provide an effective (low resistance) path for the electric current to return to the energizer's earth terminal. Larger energizers with large fence lines require more earth rods.

How does earthing work?

For an electric fence to give an electric shock the current produced by an energizer must complete a full circuit. The current leaves the energizer and moves along the fence wires through the animal, into the soil and back to the energizer via the earth system. If the earth system is ineffective the animal will receive an inadequate shock.

What factors affect your earth system?

Dry, sandy or non-conductive soil (e.g. volcanic soil) provides an ineffective earthing system. If you have this type of soil, it's a good idea to 1) use additional earth rods or 2) choose a better location for the earth system (such as damp soil) or 3) consider an alternative method of earthing such as the Fence Wire Earth Return System.

YouTube Watch our how-to video online: [Watch now!](#)

SETTING UP YOUR EARTH SYSTEM

Step one – Choose the right system for you

Option 1 – Ground Earth Return

Recommended where soil is conductive. This system is suitable for most moist soils.

Current flows through the animal and the ground back to the earth rods.

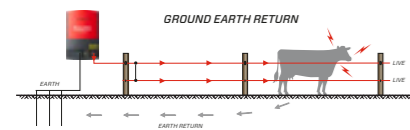

Option 2 – Fence Wire Earth Return

Recommended where soil is not conductive. If the soil is dry, sandy or volcanic it is usually not conductive.

The fence is constructed using both live and earth wires. If the animal touches the live wire, the current flows through the animal and the ground to the earth rods and back to the energizer. If the animal touches the live wire and the earth wire the current flows through the ground and fence earth wire back to the energizer.

It's recommended that earth stakes are placed every 500 m.

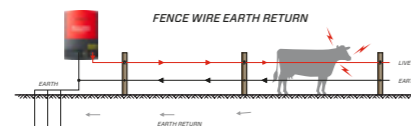

Step two – Select the site for your earth system

A suitable place for an earth system is:

- A minimum of 10 m away from other earth systems, e.g. house mains, underground power or phone lines
- Away from stock or other traffic that could interfere with the installation
- Easily accessible for maintenance
- Where there is damp soil all year round, e.g. shaded or swampy areas

TIPS

1. In some situations it is not possible to locate the earth system close to the energizer. As an alternative try using the existing fence line to connect to a remote earth system.
2. It may be necessary to water the earth system in dry weather to improve earth stake performance or increase the number of earth stakes.
3. Talk to our team to find out more.

SETTING UP YOUR EARTH SYSTEM

Step three – Insert the earth rods

The number of earth rods required depends on the type of energizer you're using to power the fence and the soil conductivity. It is recommended that you consult with your local Datamars Livestock Territory Manager for the correct number of earth rods to suit your specific location.

1. Space the required number of earth rods at least 3 m apart.
2. Ensure that the earth rods protrude out of the soil by 100 mm so they can be easily connected.

3. Connect the earth rods in series using earth clamps and insulated cable* in one continuous length without joins.

* Note you will need to strip small sections of the insulation away from the cable to connect to the earth clamp/earth rod.

Step four – Testing your earth system

Test your earth system to ensure it's working properly.

To do this:

1. Turn off the energizer.
2. Short circuit the fence to ground at least 100 m away from the energizer. This can be done by laying steel rods or pipes against the fence. In dry or sandy soils drive the rods into the soil up to 300 mm.
3. Turn on the energizer.
4. Use a digital voltmeter to measure the fence voltage. It should read less than 2 kV. If not, repeat steps 1-3 using more steel rods or pipes.
5. Attach the voltmeter clip to the last earth rod of the earthing system.
6. Insert the voltmeter probe into the soil at the full length of the leads.
7. The voltmeter reading should be no more than 0.3 kV. If the reading is higher than this, the earth system is inadequate. Therefore you will need to add more earth rods or find a better location for your earth system. It is recommended you review the checklist opposite.
8. Recommendation based on environmental conditions is 1m Earth Rod per 1 Joule of Energizer output.

EARTH SYSTEM CHECKLIST

TICK
HERE

1. All wires are joined securely
2. Connections to earth rods are secure
3. Earth rods are at least 3 m apart
4. Earth rods are at least 1 m long
5. There are a sufficient number of earth rods
6. All parts of the earth system are made of the same metal
7. The earth rods are driven deeply into the soil leaving 100 mm exposed
8. Earth rods are a minimum of 10 m away from buildings or other electrified earth systems, e.g. house mains, underground power or phone lines.

UNDERGROUND CABLE

Extreme 2.7 mm Underground Cable

- Ideal for large properties with high powered energizers
- 2.7 mm (12 ga) aluminium coated steel for extreme conductivity
- 3 x more conductive than 2.5 mm (12.5 ga) Premium Underground Cable
- 8 x more conductive than 1.6 mm (16 ga) Underground Cable
- Use with Speedrite Joint Clamps
- Resistance of 11.5 ohms / km
- Easy to strip with soft steel core for greater flexibility
- Delivers more power over long distances

Product code: 880 0000-352 (500 m spool)
880 0013-169 (100 m spool)
880 0013-173 (50 m spool)

Premium 2.5 mm Underground Cable

- Suitable for all properties
- 2.5 mm (12.5 ga) galvanised steel for greater conductivity
- 3 x more conductive than 1.6 mm (16 ga) Underground Cable
- Use with Speedrite Joint Clamps
- Resistance of 35 ohms / km
- Easy to strip with soft steel core for greater flexibility

Product code: 880 0000-356 (500 m spool)
880 0013-168 (100 m spool)
880 0013-167 (50 m spool)
880 0013-166 (25 m spool)
880 0010-855 (15 m spool)

1.6 mm Underground Cable

- Ideal for small properties with low powered energizers
- 1.6 mm (16 ga) galvanised steel
- Use with Speedrite Joint Clamps
- Resistance of 90 ohms / km
- Easy to strip with soft steel core for greater flexibility

Product code: 880 0013-165 (100 m spool)
880 0013-164 (50 m spool)
880 0013-163 (25 m spool)

Aluminium Coated Lead-out Wire

- Ideal for use in coastal and other corrosive environments
- Ideal for long lead-out with high powered energizer installations
- 2.7 mm (12 ga) aluminium coated steel for extreme conductivity
- 3 x more conductive than standard 2.5 mm (12.5 ga) galvanised wire
- Resistance of 11.5 ohms / km

Product code: 880 0000-051 (1,000 m spool)

Floodgate Controller

- Limits energy loss from heavy growth or flooding
- Fully sealed from insects and the environment
- Ideal for use near creeks, river beds and areas prone to flooding

Product code: 880 0013-126 EA

EARTH KIT

Earth Kit

- Ensured effective connection between energizer and earth, maximising the performance of your electric fence
- Pack of 3 includes: 3 x 2 m galvanised earth rods and 3 x galvanised earth clamps

Product code: 880 0013-132 (3 pack)

CUT-OUT SWITCHES

Heavy Duty Cut-Out Switch

- Use to isolate sections of electric fence with minimal disruption to your farm
- Long life stainless steel contacts
- Easily sighted on/off position
- UV stabilised for long life

Product code: 880 0013-115 EA

Earth Rod / Earth Clamp

Product code:
880 0001-414 (Earth Rod 2 meter EA)
880 0010-992 (Earth Rod 1 meter EA)
880 0013-131 (Earth Clamp 3 pack)
880 0010-999 (Earth Clamp EA)

Cut-Out Switch

- Use to isolate sections of electric fence with minimal disruption to your farm
- 2 stainless steel contacts for positive connection
- Highly visible on/off position
- Fits securely onto post
- UV stabilised for long life

Product code: 880 0000-082 (10 pack)

LIGHTNING PROTECTION

Lightning Diverter Kit

- Kit contains components needed to block and divert most voltage spikes from lightning strikes
- Includes: spring choke, insulator, joint clamps and lightning arrester

Product code: 880 0013-123 EA
880 0001-058 (Replacement Lightning Arrester)

Cut-Out Switch

- Can be used with wood posts and metal pipes
- Use to isolate sections of fence
- Stainless steel fittings for positive non-corrosive contact

Product code: 880 0013-130 EA

JOINT CLAMPS

Heavy Duty Claw Joint Clamp



- Use to create electrical connections between wires
- Galvanised construction for superior rust resistance
- Claw design allows multiple connecting wires
- Suitable for wire up to 4 mm (8 ga)

Product code: 880 0013-128 (20 pack)

Split Bolt Joint Clamp



- Use to create electrical connections between wires
- Solid zinc for superior corrosion resistance
- Ideal for coastal or other harsh environments
- Suitable for wire up to 2.7 mm (12 ga)

Product code:
880 0013-431 (30 pack)
880 0013-374 (5 pack)

L-Shape Joint Clamp

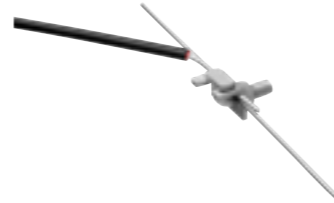

- Ensures a highly conductive connection for wire up to 4 mm
- Use to create electrical connections between wires
- High-spec galvanised construction for superior rust resistance
- Ideal for most farm conditions

Product code: 880 0013-122 (25 pack)

SIGNS

Warning Sign



- Clear warning for safety
- Signs may be required by law, refer to your local bylaws for more information

Product code: 880 0013-127 (10 pack)



POSTS AND REELS

A range of high quality, durable and easy-to-use posts, reels and accessories for temporary electric fencing.



POST SIZE COMPARISON

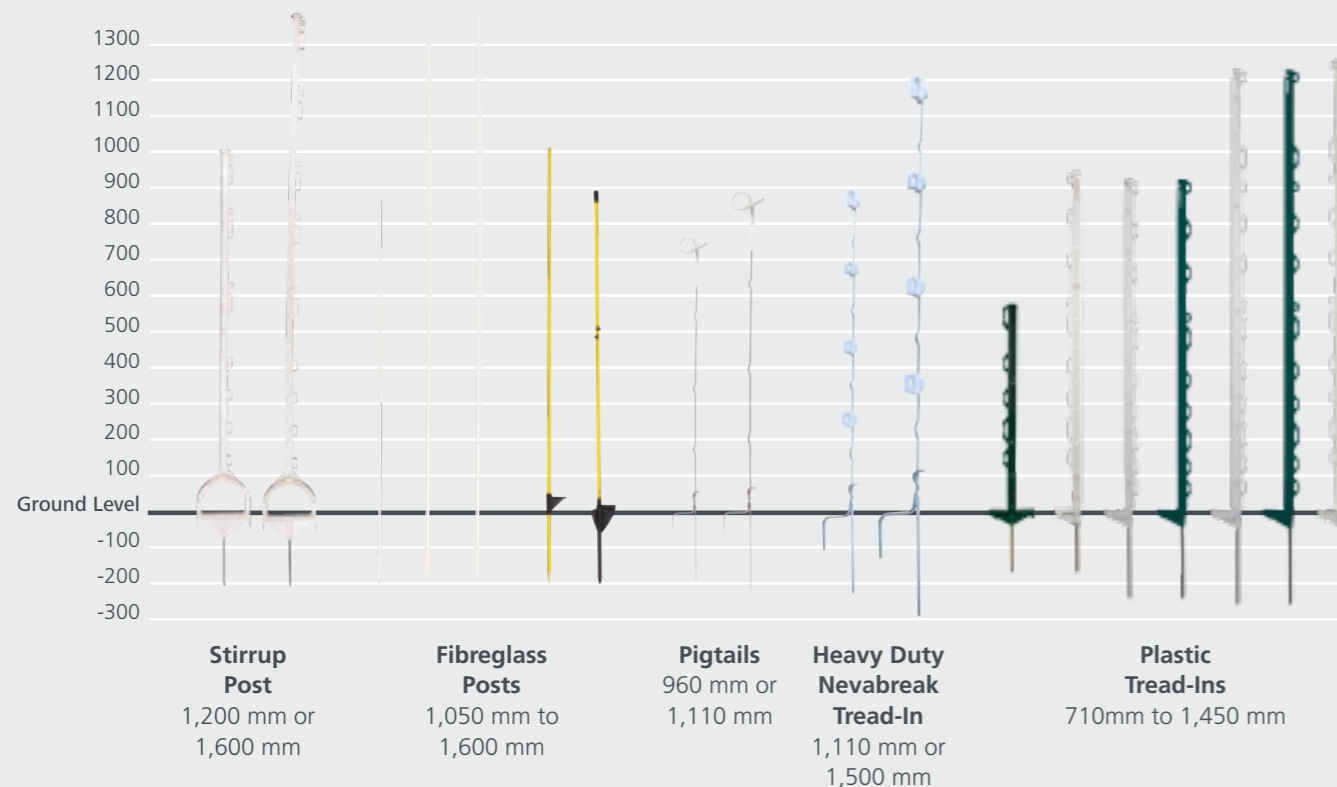

Stirrup Post



- Stirrup footplate makes it easier to push into the ground compared to traditional Tread-in posts
- Uniquely designed clips that make poliwire and politape simple to release
- Posts can be used with any size poliwire and politape up to 40 mm
- Made from extremely strong plastic
- UV treated for longer life
- 2 year warranty

Product code:

880 0013-018 (1600 mm, 10 pack)

880 0013-019 (1200 mm, 10 pack)



FIBREGLASS POSTS

Yellow Fibreglass Post with Foot



- UV stabilised, silicon bonded Fibreglass post with built in Step in Foot
- With woven polyester sleeve
- 2 year warranty

Product code:

880 0010-862 (12 mm x 1.25 m, 10 pack)

Yellow Oval Fibreglass Post with Spike & Insulator



- UV stabilised, silicon bonded Oval Fibreglass post and Spike, with middle and Top Insulator
- With woven polyester sleeve
- 2 year warranty

Product code:

880 0004-577 (1.1 m, 10 pack)

FIBREGLASS POSTS

Fibreglass Post



- UV stabilised, silicon boned fibreglass rods
- Available in a range of sizes
- 2 year warranty

Product code:

880 0010-861 (10 mm x 1.05 m, 10 pack)

880 0010-860 (10 mm x 1.35 m, 10 pack)

880 0004-576 (10 mm x 1.6 m, 10 pack)

880 0004-574 (12 mm x 1.6 m, 10 pack)

Fibreglass Post Clip



- Use with 10 mm or 12 mm fibreglass posts
- Made from stainless steel
- 2 year warranty

Product code:

880 0004-573 (10 mm Temp Clip, 50 pack)

880 0004-575 (12 mm Temp Clip, 50 pack)

HEAVY DUTY

Pigtails



- Galvanised spring steel construction
- UV stabilised for long life
- Unique rugged crimped foot design for durability
- 790 mm fence height (960 mm total height)
- Also available in heavy duty 900 mm with white insulator (1,110 mm total height)

Product code: 880 0013-146 (Heavy duty 900 mm, 10 pack)

880 0013-152 (790 mm, 10 pack)

Heavy Duty Nevabreak Tread-In



- Galvanised spring steel construction
- Up to 5 position for poliwire, tape up to 40 mm and 3 mm braid
- Available in 1,100 mm total height (900 mm fence height), and 1,500 mm total height (1,300 mm fence height)
- UV stabilised for long life
- Unique rugged crimped foot design for durability
- Extra long length suitable for equine

Product code: 880 0013-147 (1,100 mm, 10 pack)

880 0013-148 (1,500 mm, 10 pack)



TREAD-IN POSTS

Plastic Post 71cm

- Lightweight design
- 10 positions for 20 to 40 mm tape or poliwire, rope and braid up to 10 mm
- UV stabilised for long life
- 575 mm fence height (710 mm total height)
- 2 year warranty

Product code: 880 0013-421 (5 pack)

Plastic Post 108cm

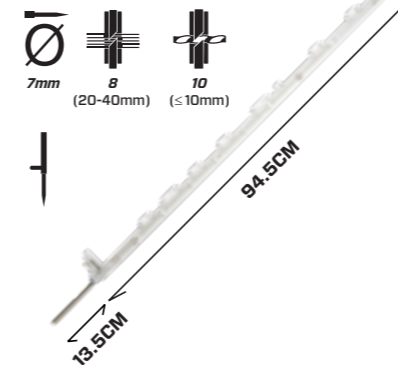

Product code: 880 0013-422 (10 pack)

Plastic Post 138cm

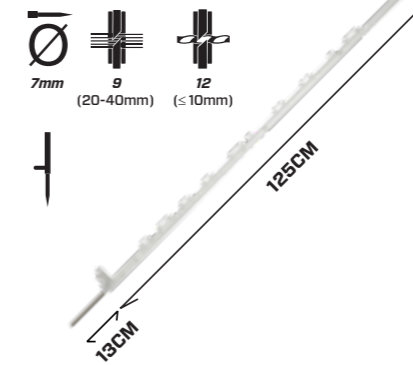

Product code: 880 0013-423 (10 pack)

Premium Post 115cm

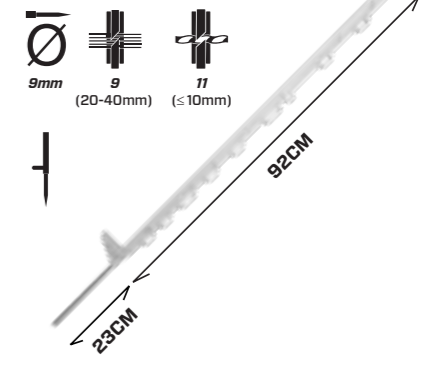

Product code: 880 0013-424 (10 pack)

Premium Post 115cm

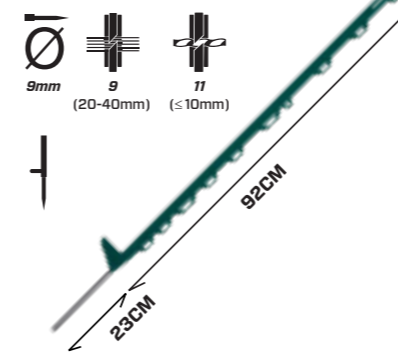

Product code: 880 0013-425 (10 pack)

Premium Post 145cm

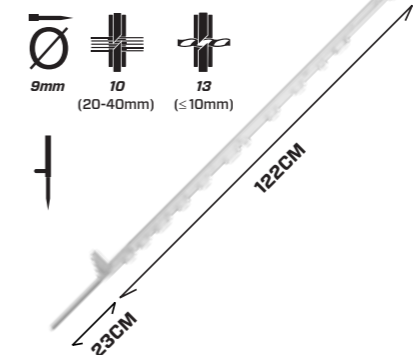

Product code: 880 0013-426 (10 pack)

Premium Post 145cm

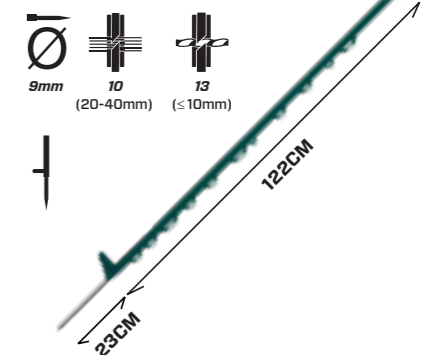

Product code: 880 0013-427 (10 pack)

REELS

REIMAGINE REELS**Extreme Geared Reel**

3:1 gear ratio and large capacity. Designed for ultimate strength and durability. High speed and smooth running.

**KEY FEATURES**

- Holds 500 m of poliwire or 200 m of 12 mm politape
- 3:1 gear ratio with a solid steel crank
- Wire tracking for even wire distribution across the bobbin
- Drag adjustment to prevent over run and tangling
- Isolated power flow through the reel frame
- On/off power switch for fingertip control
- New hook design for enhanced stability on fence or bike
- Hook fits a range of bar widths
- Frame insulated from spool
- UV stabilised materials for long life and durability
- Impact resistant Frame and Bobbin



3 Year Warranty

Product code: 880 0004-621, with bracket 880 0004-791

REELS

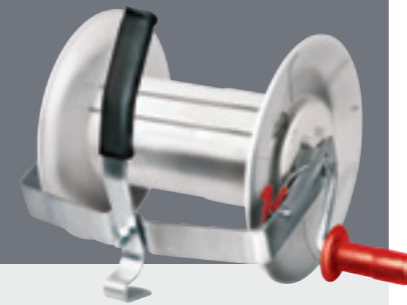
LONG LIFE**Mega 3:1 Geared Reel**

- Holds 1,000 m poliwire or 400 m politape (12 mm)
- 3:1 gear ratio with a solid steel crank
- Frame insulated from spool
- Use with carry handle or on mounting post
- UV stabilised for long life
- Galvanised steel frame
- Rugged steel locking system

Product code: 880 0013-059 EA

3:1 Geared Reel

- Holds 500 m poliwire or 200 m politape (12 mm)
- Comes as reel only or pre-wound with poliwire or tape (12 mm) and Zammr Handle
- 3:1 gear ratio with a solid steel crank
- Frame insulated from spool
- Use with carry handle or on mounting post
- UV stabilised for long life
- Galvanised steel frame
- Rugged steel locking system

Product code: 880 0013-174 EA (reel only)

Jumbo 1:1 Reel

- Holds 1,000 m poliwire or 400 m politape (12 mm)
- 1:1 gear ratio
- Frame insulated from spool
- Use with carry handle or on mounting post
- UV stabilised for long life
- Galvanised steel frame
- Rugged steel locking system

Product code: 880 0013-056

1:1 Reel

- Holds 500 m poliwire or 200 m politape (12 mm)
- Comes pre-wound or as reel only
- 1:1 gear ratio
- Frame insulated from spool
- Use with carry handle or on mounting post
- UV stabilised for long life
- Galvanised steel frame
- Rugged steel locking system

Product code: 880 0013-058 EA (reel only)

Mini 1:1 Reel

- Compact and easy to use
- Holds up to 200 m of poliwire or 100 m politape (12mm)
- Ideal for shorter lengths of fence

Product code: 880 0013-057

NETTING

Netting provides a quick and easy way to move your fence line whilst keeping your animals or crops protected.

- Strong knots for added strength
- UV Stabilized for long lasting durability
- 15 reinforced posts for enhanced vertical & horizontal stability
- Premium Cooper wires for enhanced conductivity
 - Increasing coverage distance
- Simple, easy installation
- Specifically designed for enhanced visibility

NETTING COMPARISON

	SHEEP	POULTRY	GOAT	WILD	WOLF	WILD
HEIGHT (CM)	90	110	110	120	110	165
DISTANCE BETWEEN VERTICAL WIRES (CM)	15	7.5	15	15	15	15
NUMBER OF HORIZONTAL LINES EXC. BOTTOM	7	12	8	8	9	13
NUMBER OF POSTS	15	15	15	15	15	20
POST DIAMETER	15mm	13.5mm with Reinforcement		12.6mm FRP POST		
NUMBER OF SPIKES	1	1	1	1	2	2
TOP WIRE CONDUCTOR	3x0.20mm Stainless Steel + 3x0.25mm Copper Conductors					
MIDDLE WIRES CONDUCTOR	3x0.20mm Stainless Steel					

NETTING

Sheep Netting - 90cm

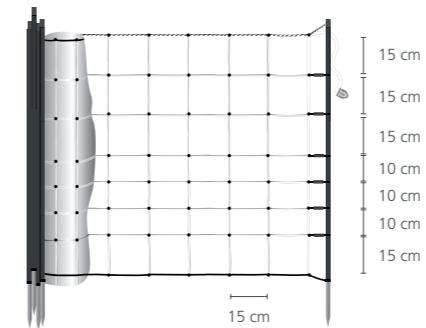

A 50m roll of electrified netting designed specifically to meet the needs of Sheep.

Product code: 880 0013-387

Poultry Netting - 110cm

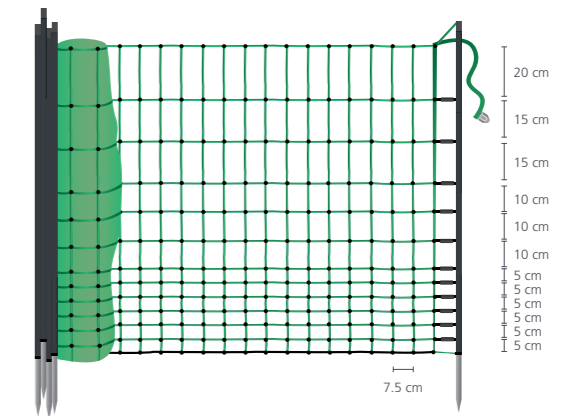

A 50m roll of electrified netting designed specifically to meet the needs of Poultry with smaller gaps at the bottom.

Product code: 880 0013-388

Goat Netting - 110cm

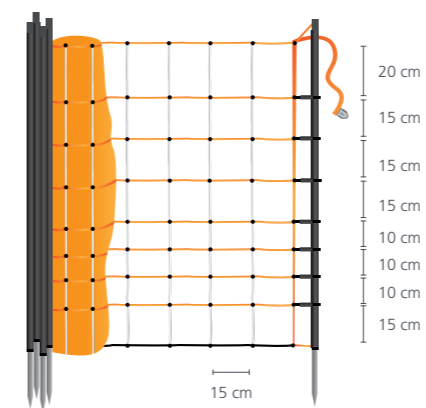

A 50m roll of electrified netting designed specifically to meet the needs of Goats.

Product code: 880 0010-389

Wild Netting - 120cm

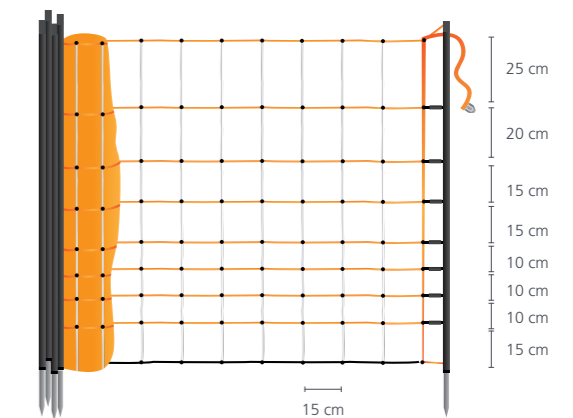

A 50m roll of electrified netting designed specifically to meet the needs of Wild animals.

Product code: 880 0013-390

NETTING

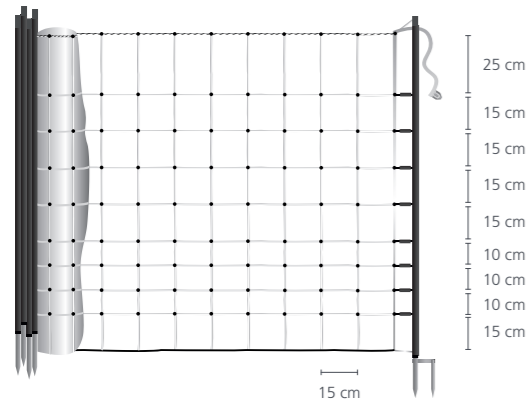
Wolf Netting - 130cm

A 50m roll of electrified netting designed specifically to meet the needs of Goats.

Product code: 880 0013-391

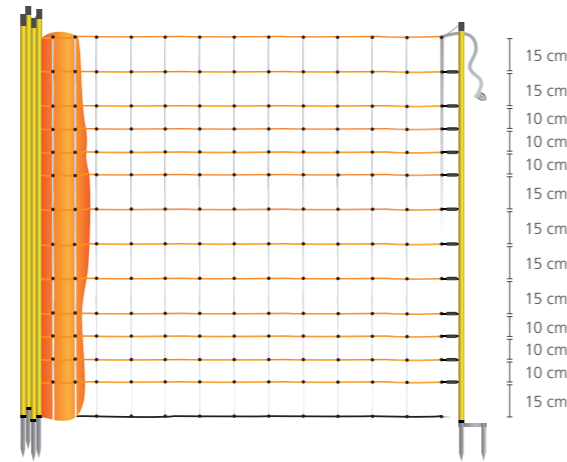
Wild Netting - 165cm

A 50m roll of electrified netting designed specifically to meet the needs of Wild animals.

Product code: 880 0013-392

Weight Management, Made Easy.

Tru-Test Walk Over Weighing and Walk On Weighing (WOW) is a world-class in-paddock weighing solution.

Placed near a water source, or an attractant, livestock quickly adjust to weighing themselves daily by walking over, or on, the WOW structure.

Delivering accurate, real-time insights and data based on individual animal weights and group averages, the system is a combination of sophisticated, yet practical algorithms and robust

hardware. Designed with ease-of-use and efficiency in mind, it's built to remove the guesswork from managing cattle.

Daily weighing data is transformed into clearly presented graphs and reports via the Datamars Livestock Live application*, which can be accessed on your smart device from anywhere in the world.



Tru-Test
DATAMARS

WOW

Tru-Test
DATAMARS

Active Tag

Accurate heat and health monitoring you can trust



Tru-Test Active Tag is an easy, simple to use and fast to install platform. Thanks to the plug & play gateway and advanced hardware technology for quick collar & tag activation you spend less time setting up and more time where it matters, with your dairy herd and business.

Receive early detection and warning of individual and herd health events with consistent, regular animal monitoring, save time, reduce treatment cost and achieve better outcomes.

Reduces stress, fatigue and the reliance on labour - especially during critical periods like calving. The Active Tag solutions, with the Datamars Livestock platform, proactively monitors your herd, and if need be, delivers an automated alert directly to you.

ADVANTAGES

- ✓ Reduce labour and treatment costs with better outcomes
- ✓ Seamlessly integrates with all existing Datamars Livestock connected solutions
- ✓ Improve heat detection rates improving calving indexes and days in milk
- ✓ Joining our 60-year legacy of tried, trusted, high-value livestock solutions



Tru-Test Active Tag leverages advanced machine learning algorithms to tailor heat detection specifically to your herd dynamics and farm ecosystem.

Every missed heat costs on average €149.50 due to slip in calving date & for the increased likelihood of cows not in calf in a 12-week breeding season. *Source: Teagasc Moorepark*

DATAMARS
Livestock.

To find out more about our Tru-Test Active Tag solutions and our Smart Farming initiatives, scan the code or enter the URL below.
www.datamars.co.uk/ecosystems



WIRE, TAPE, BRAID & ROPE

Select from our Poli range, depending on your needs. All Speedrite Poli products are UV stabilised for long life.



The **Extreme** range provides the ultimate in conductivity and strength for

more demanding professional livestock control operations. Up to 6 tinned copper strands for extreme shock power.

5 YEAR UV WARRANTY



The **Premium** range provides greater conductivity and strength for

demanding professional livestock control operations. Up to 10 stainless steel strands for greater shock power.

5 YEAR UV WARRANTY



The **Poli** range provides effective conductivity and strength for

professional livestock control applications. 6 stainless steel strands for shock power.

2 YEAR UV WARRANTY



WIRE

Extreme Sighter Wire 8mm

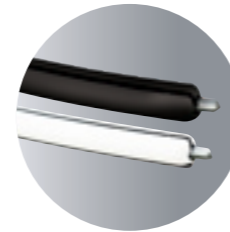

- High tensile wire coated in a highly conductive carbon compound to deliver low voltage shocks
- Highly visible to help prevent animal entanglement
- 8mm diameter for animal safety
- Resistance: 0.035 ohms/meter
- 10 year warranty

Product code:
880 0013-194 (white, 250 m)
880 0013-195 (black, 250 m)

Extreme Poliwire

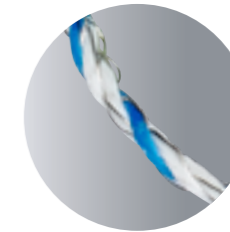

- Ideal for semi-permanent fences longer than 500 metres
- Stronger, visible and highly conductive
- Ideal for wild animals and fences with heavy vegetation
- 50x more conductive than our standard Poliwire
- 2 year warranty

Product code:
880 0013-377 (1000 m)
880 0013-029 (400 m)
880 0013-376 (200 m)

Premium Poliwire

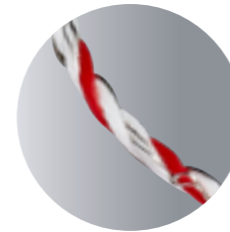

- Ideal for semi-permanent fences longer than 500 metres
- Strong, visible and ideal for difficult animals and fences
- 18x more conductive than our standard Poliwire
- 2 year warranty

Product code: 880 0013-027 (1000 m)
880 0013-028 (400 m)
880 0013-375 (200 m)

Poliwire

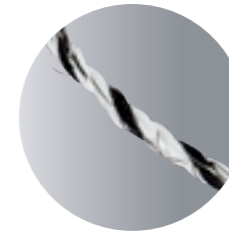

- Ideal for temporary fencing up to 500m
- Reliable and visible fence wire
- 2 year warranty

Product code: 880 0013-024 (500 m)
880 0013-023 (200 m)

Poliwire

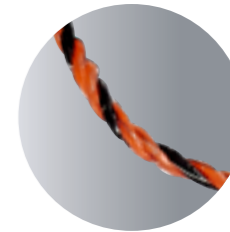

- Ideal for temporary fencing up to 500m
- Reliable and visible fence wire
- 2 year warranty

Product code: 880 0013-026 (500 m)
880 0013-025 (200 m)

Extreme Poliwire White/Blue	Premium Poliwire White/Red	Poliwire White/Black	Poliwire Orange/Black
3 X 0.20SS 3 X 0.25Cu	8 X 0.20SS 1 X 0.25Cu	6 X 0.16SS	6 X 0.16SS
0.12 Ω/M	0.35 Ω/M	6.41 Ω/M	6.41 Ω/M
116 KG	116 KG	68 KG	68 KG
50x more conductive than our standard Poliwire	18x more conductive than our standard Poliwire		

TAPE

Extreme 40 mm Tape

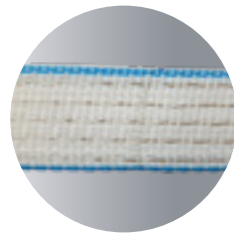

- Ideal for difficult, semi-permanent fences longer than 500 metres
- Heavy duty tape, tightly woven for superior strength
- Cross conductor for increased fault tolerance
- 56 x more conductive than standard 12 mm Politape
- 2 year warranty

Product code:
880 0013-037 (200 m)

Extreme 40 mm Brown Tape

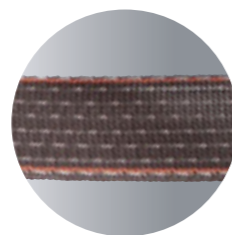

- Ideal for difficult, semi-permanent fences longer than 500 metres
- Heavy duty tape, tightly woven for superior strength
- 82 x more conductive than standard 12 mm Politape
- 2 year warranty

Product code:
880 0013-188 (200 m)

Premium 40 mm Tape

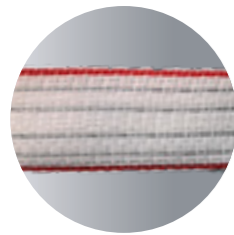

- Ideal for temporary fencing up to 500m
- Visible with strong PE filaments fence tape
- 3.1 x more conductive than standard Politape
- 2 year warranty

Product code:
880 0013-033 (200 m)

Extreme 20 mm Tape

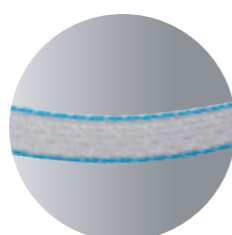

- Ideal for difficult, semi-permanent fences longer than 500 metres
- Heavy duty tape, tightly woven for superior strength
- Cross conductor for increased fault tolerance
- 53 x more conductive than standard 12 mm Politape
- 2 year warranty

Product code:
880 0013-036 (200 m)

Premium 20 mm Tape

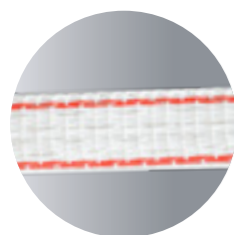

- Ideal for temporary fencing up to 500m
- Visible with strong PE filaments fence tape
- 2.3 x more conductive than standard 12 mm Politape
- 2 year warranty

Product code:
880 0013-032 (200 m)

Extreme 12 mm Tape

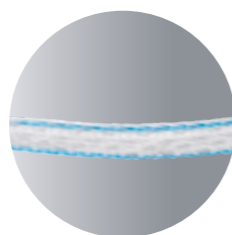

- Ideal for difficult, semi-permanent fences longer than 500 metres
- Heavy duty tape, tightly woven for superior strength
- Cross conductor for increased fault tolerance
- 53 x more conductive than standard 12 mm Politape
- 2 year warranty

Product code:
880 0013-035 (400 m)
880 0013-034 (200 m)

TAPE

Premium 12 mm Tape

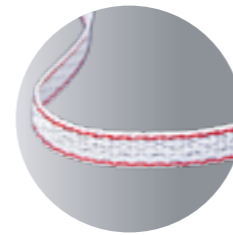

- Ideal for temporary fencing up to 500m
- Visible with strong PE filaments fence tape
- 1.5 x more conductive than standard 12 mm Politape
- 2 year warranty

Product code:
880 0013-031 (400 m)
880 0013-030 (200 m)



Extreme 40 mm Tape	Extreme 40 mm Horse Tape	Premium 40 mm Tape	
8 X 0.25SS 2 X 0.25Cu	8 X 0.30SS 2 X 0.30Cu	8 X 0.20SS	
Ω 0.16 Ω/M	Ω 0.11 Ω/M	Ω 2.9 Ω/M	
255 KG	260 KG	250 KG	
56 x more conductive than standard 12 mm Politape	82 x more conductive than standard 12mm Politape	3.1 x more conductive than standard 12 mm Politape	
Extreme 20 mm Tape	Premium 20 mm Tape	Extreme 12 mm Tape	Premium 12 mm Tape
4 X 0.25SS 2 X 0.25Cu	6 X 0.20SS	3 X 0.25SS 2 X 0.25Cu	4 X 0.20SS
Ω 0.17 Ω/M	Ω 3.9 Ω/M	Ω 0.17 Ω/M	Ω 5.85 Ω/M
168 KG	145 KG	112 KG	90 KG
53 x more conductive than standard 12 mm Politape	2.3 x more conductive than standard 12 mm Politape	53 x more conductive than standard 12mm Politape	1.5 x more conductive than standard 12mm Politape

BRAID

Extreme 6 mm Braid



- Ideal for difficult and semi-permanent fences longer than 500 metres
- Heavy duty 6 mm diameter for greater visibility and strength
- Thick copper conductors for extra power delivery
- Stretch resistant
- 86x more conductive than standard Poliwire

Product code:
880 0013-042 (400 m)



Extreme 3 mm Braid

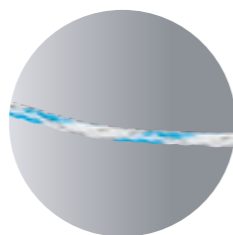

- Ideal for semi-permanent fences longer than 500 metres
- Heavy duty braid and more visible than wire with extra conductivity
- Stretch resistant
- 50x more conductive than standard Poliwire

Product code:
880 0013-365 (200 m)
880 0013-041 (400 m)
880 0013-379 (1000 m)

Premium 3 mm Braid

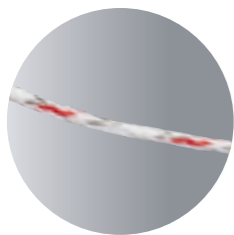

- Ideal for temporary fencing up to 500m
- Heavy duty braid and more visible than wire
- Stretch resistant
- 2x more conductive than standard Poliwire

Product code:
880 0013-040 (400 m)
880 0013-378 (200 m)

Extreme 3 mm Blue Braid

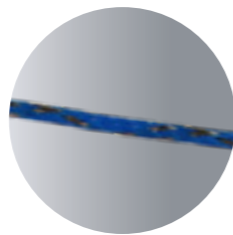

- Ideal for semi-permanent fences longer than 500 metres
- Heavy duty braid and more visible than wire with extra conductivity
- Stretch resistant
- 50x more conductive than standard Poliwire

Product code:
880 0013-432 (1000 m)
880 0013-433 (400 m)
880 0013-434 (200 m)

Extreme 6 mm Braid	Extreme 3 mm Braid	Premium 3 mm Braid
<p>6 X 0.20SS 3 X 0.30Cu</p> <p>Ω 0.09 Ω/M</p> <p>220 KG</p> <p>86x more conductive than standard Poliwire</p>	<p>9 X 0.20SS 2 X 0.25Cu</p> <p>Ω 0.12 Ω/M</p> <p>88 KG</p> <p>50x more conductive than standard Poliwire</p>	<p>9 X 0.20SS</p> <p>Ω 2.6 Ω/M</p> <p>88 KG</p> <p>2x more conductive than standard Poliwire</p>

ROPE

Extreme 6 mm Rope

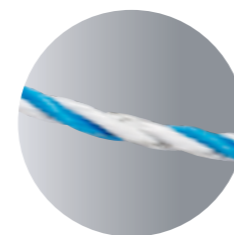

- Ideal for semi-permanent fences longer than 500 metres
- 6 mm diameter for greater visibility and strength
- Thick stainless steel and copper conductors make the rope super conductive
- Stretch resistant
- 50x more conductive than standard Poliwire

Product code:
880 0013-039 (200 m)



Premium 6 mm Rope



- Ideal for semi-permanent fences longer than 500 metres
- 6 mm diameter for greater visibility and strength
- The copper conductor improves performance on difficult vegetation
- Stretch resistant
- 16x more conductive than standard Poliwire

Product code:
880 0013-038 (200 m)



Extreme 6 mm Rope	Premium 6 mm Rope
<p>6 X 0.30SS 3 X 0.25Cu</p> <p>Ω 0.16 Ω/M</p> <p>500 KG</p> <p>50x more conductive than standard Poliwire</p>	<p>5 X 0.20SS 1 X 0.25Cu</p> <p>Ω 0.38 Ω/M</p> <p>432 KG</p> <p>16x more conductive than standard Poliwire</p>

SPEEDRITE HIGH TENSILE WIRE

EXTREME

High Tensile Wire

Wire Dispensers available in the HAYES section.

The unique zinc-aluminum alloy coating of Speedrite High Tensile Wire provides superior resistance to atmospheric corrosion and chemicals. Moreover, its smooth, homogeneous surface prevents cracks, ensuring ensure that corrosion protection remains optimal despite extreme twisting and bending.

Specifically designed for long life performance, optimum strength & superior long distance conductivity ensuring low resistance on your well installed fence line.

Excellent conductivity (2.50mm = 0.035 ohms)

Product code: 880 0001-588 (Cyclone 1.6mm), 880 0013-435 (2.0mm), 880 0013-380 (2.5mm) 10 Year Warranty

DIAMETER (MM)	WIRE (GUAGE)	LENGTH (M) 25KG COIL	MINIMUM BREAK LOAD (KG FORCE)	RECOMMENDED TENSION (KG FORCE)
1.60	16g	1584	220	80
2.00	14g	1000	380	110
2.50	12	650	592	150

CONNECTORS

Simplify your fence construction and ensure maximum power flow with the Speedrite range of electric fence connectors.

Designed to suit a variety of poli tape, Speedrite connectors keep your electricity flowing and your fence line tight.



2 Year Warranty



CONNECTORS

Energizer to Wide Tape Connector

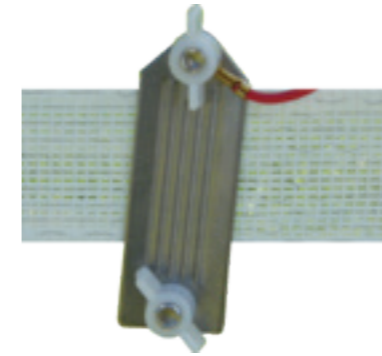

- Use to connect polytape to energizer
- Suitable for use with polytape up to 40 mm wide

Product code: 880 0013-178 EA

Tape to Tape Connector

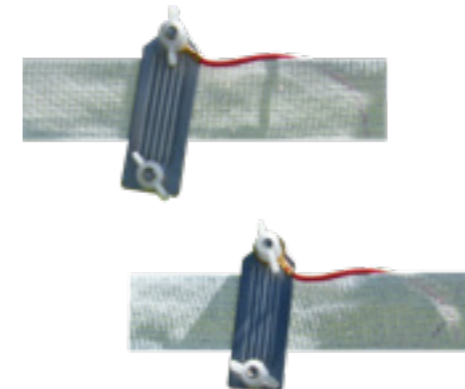

- Allows the electricity from one polytape strand to be transmitted vertically to the polytape strand below
- Suitable for use with polytape up to 40 mm wide

Product code: 880 0013-180 EA

Energizer to Rope/Braid Connector



- Use to connect poliropo or braid strands to energizer
- Suitable for use with poliropo or braid

Product code: 880 0013-179 EA

Tape Buckle



- Use to join or splice polytape
- Angled end can be used to connect polytape to gate handle
- Suitable for use with polytape up to 12 mm wide

Product code: 880 0013-181 (5 pack)

CONNECTORS

Tape Buckle

- Use to join or splice polytape
- Angled end can be used to connect polytape to gate handle
- Suitable for use with polytape up to 40 mm wide

Product code: 880 0013-182 (5 pack)

Tape Gate Buckle

- For use with Premium Gate Tape

Product code: 880 0013-129 (10 pack)

**Wide Tape Joiner
40mm**

- Use to join up to 40 mm wide tape

Product code: 880 0013-048 (5 pack)

Braid/Rope Clamp

- Use to join polyrope and braid
- Suitable for use with polyrope or braid

Product code: 880 0013-183 (3 pack)

**Rope to Rope
Connector**

- Allows the electricity from one polyrope or braid strand to be transmitted vertically to the polyrope or braid strand below
- Suitable for use with polyrope or braid

Product code: 880 0013-184 EA

JUMPER LEADS

Jumper Leads

Recommended for ensuring good electrical connections in temporary fencing

Product code: 880 0013-124 (Single Jumper EA)
880 0013-125 (Triple Jumper EA)



INSULATORS AND STRAINERS

Speedrite insulators are reliable, strong and UV stabilised for long life in permanent fencing.



WOOD POST

Wood Post Ring Insulator - Long Support



- Suits poli wires, ropes and braid up to 4 mm
- Long steel support for strength and reinforcement
- UV resistant
- 2 year warranty

Product code: 880 0013-363 (50 pack)
880 0013-003 (125 bucket)

Wood Post Jumbo Ring Insulator



- Suits poli wires, ropes and braid up to 10 mm
- Excellent arcing protection
- UV resistant
- 2 year warranty

Product code: 880 0013-005, Black (25 pack)
880 0013-006, White (25 Pack)

Wood Post Dual - Purpose Ring Insulator



- Suits poli tape up to 20 mm
- Also suits poli wire or rope up to 6 mm
- UV resistant
- 2 year warranty

Product code: 880 0013-004 (25 pack)

Screw In Wide Tape Insulator

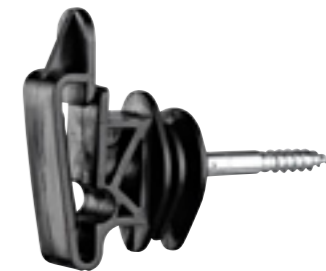

- For tapes up to 40 mm
- Also suits poli wire, rope or braid 5mm
- UV resistant
- 2 year warranty

Product code: 880 0013-008 (25 pack)

WOOD POST

Small Screw Wood Post Insulator



- High quality plastic against impacts
- UV stabilized PP copolymer
- Rounded edges to prevent the conductor from fraying
- Robust Ø 5 mm screw
- Suitable for wooden posts for wire, cord and tape up to 10 mm

Product code: 880 0013-436 (25 pack)
880 0013-437 (125 bucket)

Maxi Screw-In Ring Insulator



- High quality plastic against impacts
- UV stabilized PP copolymer
- Reinforced design to increase its durability
- Rounded edges to prevent the conductor from fraying
- Robust Ø 6 mm self-piercing screw to make the installation safer, easier and faster
- Suitable for wooden posts for wire, cord and tape up to 12,5 mm.

Product code: 880 0013-440 (25 pack)
880 0013-441 (125 bucket)

Screw Wood Post Insulator



- High quality plastic against impacts
- UV stabilized PP copolymer
- Rounded edges to prevent the conductor from fraying
- Robust Ø 5 mm screw
- Suitable for wooden posts for wire, cord and tape up to 10 mm

Product code: 880 0013-438 (25 pack)
880 0013-439 (125 bucket)

Reinforced Screw Wood Post Wire Insulator



- High quality plastic against impacts
- UV stabilized PP copolymer
- Rounded edges to prevent the conductor from fraying
- Robust Ø 6 mm self-piercing screw to make the installation safer, easier and faster
- Suitable for wooden posts for wire, cord and tape up to Ø 6 mm

Product code: 880 0013-443 (25 pack)

WOOD POST

Reinforced 10 Cm Shaft Screw Wood Post Wide Tape And Rope Insulator



- 10 cm offset insulator
- High quality plastic against impacts
- UV stabilized PP copolymer
- Rounded edges to prevent the conductor from fraying
- Robust Ø 6 mm self-piercing screw to make the installation safer, easier and faster
- Suitable for wooden posts for cord up to Ø 6 mm or tape of 40 mm

Product code: 880 0013-445 (20 pack)

ROD

Tape Insulator For Rod Posts



- High quality plastic against impacts
- UV stabilized PP copolymer
- Up to Ø 14 mm rod posts
- Rounded edges to prevent the conductor from fraying
- Adjustable insulator with anti-rotation and anti-slip tightening ring
- Suitable for wooden posts for cord up to Ø 6 mm or tape of 40 mm

Product code: 880 0013-448 (25 pack)

Post Insulator For Wire And Cord



- High quality plastic against impacts
- UV stabilized PP copolymer
- Up to Ø 14 mm posts
- Adjustable insulator with anti-rotation and anti-slip tightening ring
- Suitable for fiberglass and metal posts for cord and wire up to Ø 6 mm.

Product code: 880 0013-446 (25 pack)
880 0013-447 (50 bucket)

Multi-Fit Rod Post Insulator



- Suitable for up to 4 mm (8 ga) wire or up to 7 mm rope, braid and poliwire
- Back end slot with anti slip-out hooks holds tape up to 12 mm
- UV stabilised for long life
- Flexible design and heavy duty screw nut for a secure fit
- Spark guards prevent arcing and increased distance from wire to post reduces risk of leakage
- Fits rod posts 6 mm to 14 mm in diameter
- 2 year warranty

Product code: 880 0013-092 (25 pack)

WOOD POST

Wood Post Wide Tape Corner/End Insulator

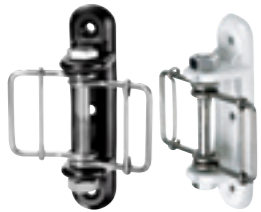

- Use with tape up to 40 mm
- Use as corner or end strain insulator
- UV stabilised for long life
- 2 year warranty

Product code: 880 0013-009 (black, 2 pack)
880 0013-010 (white, 2 pack)

Wood Post Jumbo Claw Insulator

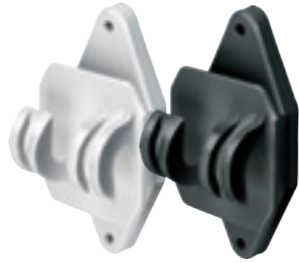

- Use with up to 8 mm rope, braid, or electrified sighter wire
- UV stabilised for long life
- Large spark guard prevents arcing and increased distance from wire to post reduces risk of leakage
- 10 year warranty

Product code: 880 0013-049 (white, 25 pack)
880 0013-000 (black, 25 pack)

Wood Post Wide Tape Claw Insulator



- Suits tapes up to 40 mm
- Spark guard to prevent arcing
- UV resistant
- On curves, install so tape pressure is applied to post
- 2 year warranty

Product code: 880 0013-001 (25 pack)

Wide Tape Wood Post Insulator

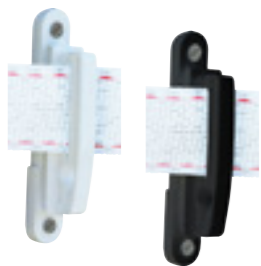

- Use with tape up to 40 mm wide, rope, braid or electrified sighter wire
- UV stabilised for long life
- 2 year warranty

Product code: 880 0013-047, White (25 Pack)
880 0013-185 Black (25 Pack)

Wood Post Hi-Strain Insulator

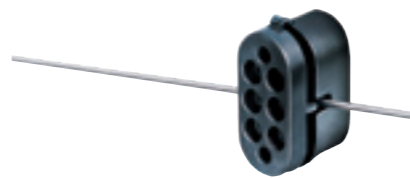

- High strength insulator designed for high and low points of hill country fences
- UV stabilised for long life
- Includes: 2 x 75 mm twisted galvanised nails
- 10 year warranty

Product code: 880 0013-368 (40 pack)

Wood Post Nail On Insulator



- Ideal for smaller farms
- Suitable for up to 2.5 mm wire
- UV stabilised for long life
- Easy to install
- Includes 75 mm twisted galvanised nail
- 2 year warranty

Product code: 880 0013-111 (25 pack)

WOOD POST

Wood Post Pinlock Insulator



- Rugged pinlock design
- UV stabilised for long life
- Unique staple guides
- Twin spark guards prevent arcing and increased distance from wire to post reduces risk of leakage
- Suitable for up to 4 mm (8 ga) wire, poliwire or braid
- High strength pinlock, conveniently allows easy removal of wires
- 10 year warranty

Product code: 880 0013-104 (25 pack)
880 0013-105 (125 bucket)

Wood Post Claw Insulator



- Rugged claw design
- UV stabilised for long life
- Unique staple guides
- Twin spark guards prevent arcing and increased distance from wire to post reduces risk of leakage
- Suitable for up to 4 mm (8 ga) wire, poliwire or braid
- 10 year warranty

Product code: 880 0013-107 (25 pack)
880 0013-108 (125 bucket)

Ring Insulator Tool



- Use with drill to install ring insulators into wood posts
- Can also be used to remove insulators from posts
- Galvanised steel for corrosion resistance
- 2 year warranty

Product code: 880 0013-045 (EA)

Power Staple Guide Attachment



- Exclusive guide attachment required for insulator to work with STOCKade ST400/ST400i fencing staplers and staples
- Designed to guide staples safely and accurately through Power Staple Wood Post Claw Insulator
- 2 year warranty

Product code: 880 0013-097 (EA)

Power Staple Wood Post Claw Insulator



- Designed for use with 45 and 50 mm length STOCKade divergent point barbed fencing staples
- Fire staples safely with both hands completely clear of the wood post
- Fast and safe reloading of insulator onto the stapler guide to minimise down time
- Robust claw design holds the wire securely
- Back design follows the curvature of the wood post, for a secure hold
- 10 year warranty

Product code: 880 0013-098 (125 bucket)

WOOD POST

Wood Post Staple On Insulator



- Ideal for smaller farms
- UV stabilised for long life
- Single piece moulding for easy application
- Suitable for up to 2.5 mm (12.5 ga) wire
- Includes diamond point staple
- 10 year warranty

Product code: 880 0013-091 (50 pack)

Wood Post Gate Anchor Insulator



- Economical option for building a gate between wood posts
- For use on wood posts
- Suitable for use with poliwire, poliropo, steel/aluminum wire

Product code: 880 0013-373 (4 pack)

Corner Pulley



- Suits most types of electric fence wire
- Use to continue fence line in corners
- UV resistant
- 2 year warranty

Product code: 880 0013-014 (5 Pack)

Y Post Bolt On Ring Insulator - M6



- Suits poli wires, ropes and braid up to 4mm
- M6 threaded shaft
- UV resistant
- 2 year warranty

Product code: 880 0013-415 (50 pack)
880 0013-017 (125 bucket)

Y POST

Heavy Duty Y Post Pinlock Insulator



- Rugged self locking, tapered pins for easy removal of wires
- UV stabilised for long life
- Suitable for most sizes of fence wire
- Spark guard prevents arcing and increased distance from wire to post reduces risk of leakage
- High strength pinlock, conveniently allows easy removal of wires
- 10 year warranty

Product code: 880 0013-103 (20 pack)
880 0013-093 (125 bucket)

Universal Y Post Pinlock Insulator



- Suitable for use with most steel posts including JIO Star™*, JIO MaxY™* and standard Y-posts
- Ergonomic twin-pin design for fast and easy attachment
- Pinlock design allows for easy wire removal if required
- Suitable for use with most fence wires including sighter wire, up to 8 mm
- UV stabilised for long life
- Increased size provides superior strength and twin spark guards prevent arcing
- 10 year warranty

Product code: 880 0013-095 (20 pack)
880 0013-096 (125 bucket)

Y POST

Y-Post Wide Tape Insulator

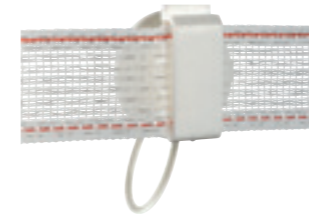

- Use with tape up to 40 mm wide, rope, braid or electrified sighter wire
- UV stabilised for long life
- Spark guard prevents arcing and increased distance from wire to post reduces risk of leakage
- 2 year warranty

Product code: 880 0013-055 (25 pack)

Post Cap Topper



- Side & top fixing options for tape up to 40 mm or wire up to 8 mm
- UV stabilised for long life
- Easily attaches to T and Y-posts
- 10 year warranty

Product code: 880 0013-050 (10 pack)



TREAD-IN

Tread-In Insulator

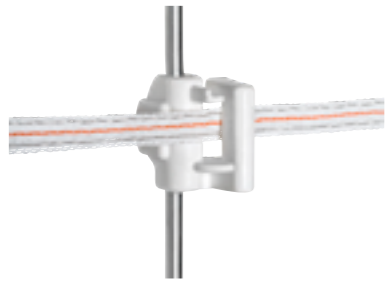

- For use with Pigtail and Nevabreak Tread-Ins
- Designed for poliwire and politape up to 40 mm
- 10 year warranty

Product code:

880 0013-021 (small, 25 Pack)

880 0013-022 (large, 25 Pack) 

Concrete Post Insulator



- Suitable for up to 4 mm (8 ga) wire, poliwire or braid
- UV stabilised for long life
- Spark guards prevent arcing and increased distance from wire to post reduces risk of leakage
- Includes galvanised steel pin
- 10 year warranty

Product code: 880 0013-109 (25 pack)

Insultube



- Economical insulator fastened with staples (staples not included)
- 2 year warranty

Product code:

880 0000-199 6mm/12mm x 100m

880 0010-979 4.5mm/10mm x 12m

880 0010-981 4.5mm/10mm x 100mm - 50 pack

880 0013-407 4.5mm/10mm x 100m

END STRAIN

Porcelain Bobbin Insulator



- High quality, long life porcelain
- White glaze finish
- 41 mm diameter
- 2 year warranty

Product code: 880 0013-100 (10 pack)

Porcelain End Strain Insulator



- Suitable for high strain use
- High quality long life porcelain
- Deep grooves hold wire in place and prevent twisting under tension
- White glaze finish
- 2 year warranty

Product code: 880 0013-102 (10 pack)

Extreme End Strain Insulator White



- Reinforced glass filled polymer for maximum strength
- Suitable for high strain use
- Superior UV stabilisation for long life
- Deep grooves hold wire in place and prevent twisting
- Long leakage path prevents arcing
- Use with most sizes of fence wire
- 10 year warranty

Product code:

880 0013-381 (6 pack)

880 0013-408 (35 pack)

End Strain Insulator Black



- Suitable for high strain use
- UV stabilised for long life
- Deep grooves hold wire in place and prevent twisting under tension
- Long leakage path prevents arcing
- Use with most sizes of fence wire
- 10 year warranty

Product code:

880 0013-382 (6 pack)

880 0013-409 (35 pack)

STRAINERS

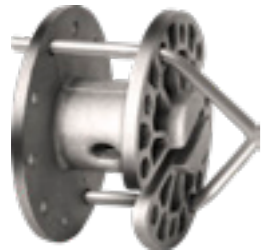
In Line Strainer

- Suitable for high strain use
- Can be added to fence without cutting wire
- Designed to work with In Line Strainer Handle or 12 mm drive ratchet
- Rust resistant
- Rugged and easy to use
- Lightweight high strength aluminium construction

Product code: 880 0013-155 (25 pack)

In Line Strainer Handle

- Galvanised handle for In Line Strainer
- Rust resistant
- Rugged and easy to use

Product code: 880 0000-099 EA

Spring Clip Strainer

- Suitable for high strain use
- Spring clip design for easy tensioning
- Rust resistant
- Galvanised frame with aluminium spool
- Rugged and easy to use'

Product code: 880 0013-159 (10 pack)

Hayes Tightening Handle

- Use in conjunction with permanent wire strainers to tighten fence wire

Product code: 880 0000-133

Porcelain Insulated Strainer

- Suitable for high strain use
- Spring clip design for easy tensioning
- Porcelain insulator for strength and durability
- Rust resistant
- Galvanised frame with aluminium spool
- Rugged and easy to use

Product code: 880 0013-160 (10 pack)

Porcelain Bullnose Strainer

- Suitable for high strain use
- Spring clip design for easy tensioning
- Heavy duty porcelain insulator for strength, durability and protection against arcing
- Fire and rust resistant
- Galvanised frame with aluminium spool
- Rugged and easy to use

Product code: 880 0013-157 (10 pack)

STRAINERS

Insulated Strainer White

- Suitable for high strain use
- Spring clip design for easy tensioning
- Heavy duty insulator protects against arcing
- Rust resistant
- Galvanised frame with aluminium spool
- Rugged and easy to use
- UV stabilised for long life

Product code: 880 0013-161 (10 pack)

Insulated Strainer Black

- Suitable for high strain use
- Spring clip design for easy tensioning
- Heavy duty insulator protects against arcing
- Rust resistant
- Galvanised frame with aluminium spool
- Rugged and easy to use
- UV stabilised for long life

Product code: 880 0013-162 (10 pack)

Bullnose Insulated Strainer

- Suitable for high strain use
- Spring clip design for easy tensioning
- Heavy duty insulator protects against arcing
- Rust resistant
- Galvanised frame with aluminium spool
- UV stabilised for long life
- Rugged and easy to use

Product code: 880 0013-156 (10 pack)

Insulated Wire Loop Strainer

- Suitable for high strain use
- Wire loop for speed and ease of installation
- Spring clip design for easy tensioning
- Heavy duty insulator protects against arcing
- Rust resistant
- Galvanised frame with aluminium spool
- UV stabilised for long life
- Rugged and easy to use

Product code: 880 0013-020 (10 pack)

Heavy Duty Temperature Compensation Spring

- 9" (230 mm) spring
- Helps properly tension wire on permanent fences

Tension Springs are designed to be used in line or at the end of the fence to maintain tension. Tension can be lost due to temperature fluctuations which cause the wire to expand and contract, tension springs ensure wire remains evenly tensioned throughout the year.

Product code: 880 0013-371

Economy Temperature Compensation Spring

- Helps properly tension wire on permanent fences
- Made of high quality zinc-plated steel
- Excellent conductivity

Product code: 880 0013-372

OUTRIGGERS, STANDOFFS AND OFFSETS

Speedrite outriggers help to preserve the life of permanent electric fences.



2 Year Warranty

Simply attach outriggers and run an electrified wire through them to keep stock off the fence.

OUTRIGGERS

Wood Post Outrigger Side Fixing



- Galvanised spring steel construction
- UV stabilised for long life
- Available lengths: 150 mm, 270 mm, 400 mm

Product code:
880 0013-134 (white, 400 mm, 5 pack)
880 0013-135 (white, 270 mm, 5 pack)
880 0013-136 (white, 150 mm, 5 pack)

Wood Post Outrigger Top Fixing



- Galvanised spring steel construction
- UV stabilised for long life
- Available lengths: 150 mm, 270 mm, 400 mm

Product code:
880 0013-133 (white, 400 mm, 5 pack)
880 0013-139 (white, 270 mm, 5 pack)
880 0013-137 (white, 150 mm, 5 pack)

Double Steel Post Quicklock Outrigger 600mm



- Smart bracket design for quick and easy installation
- 6 mm spring steel construction
- Zinc plated to withstand harsh conditions
- UV stabilised for long life

Product code: 880 0013-140 (5 pack)

OUTRIGGERS

Double Ended Wood Post Outrigger 860mm



- Galvanised spring steel construction
- UV stabilised for long life

Product code: 880 0013-138 (10 pack)

STANDOFFS

Pinlock Wire Standoff



- Ideal for installing electric fencing onto existing non-electrified fences
- Constructed from high tensile galvanised steel
- UV stabilised pinlock insulator for easy wire insertion and removal

Product code: 880 0013-141 (50 pack)

Offset Wide Tape Insulator



- For tapes up to 40 mm
- 18 cm shaft length
- UV resistant
- 2 year warranty

Product code: 880 0013-013 (10 pack)

OFFSETS

10 Cm Shaft Screw Wood Post Ring Insulator



- 10 cm offset insulator
- High quality plastic against impacts
- UV stabilized PP copolymer
- Rounded edges to prevent the conductor from fraying
- Robust Ø 6 mm self-piercing screw to make the installation safer, easier and faster
- Suitable for wooden posts for wire, cord and tape up to 10 mm

Product code: 880 0013-442 (25 pack)

Offset Ring Insulator



- Suits poli wires, ropes and braid
- 20 cm shaft length
- UV resistant
- 2 year warranty

Product code: 880 0013-011 (10 pack)

Offset Ring Insulator - Angled



- Suits poli wires, ropes and braid
- 20 cm shaft length
- UV resistant
- 2 year warranty

Product code: 880 0013-012 (10 pack)

GATE HARDWARE

An economic, effective and simple way to set up your electric fence gate system.

Gates come in bungy, spring or tape variations depending on your needs and preference.



2 Year Warranty



GATE HARDWARE

Extreme Reflective Tape Gate

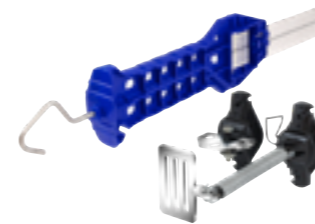

- Includes reflective tape for high visibility and safety across gateways
- Electrifies gateways up to 5 m wide
- Robust flat profile handle with strong stainless steel backbone for high conductivity and corrosion resistance
- Versatile and easy to install.
- Includes: dual purpose gate handle, x2 heavy duty wood post pinlock insulators, buckle, activator plate and reflective tape

Product code: 880 0013-193 (EA)

Tape Gate



- Electrifies gateways up to 5 m wide
- Versatile and easy to install
- Fully insulated, heavy duty handle with protective guards and non-slip grip
- Designed for maximum visibility with 40 mm wide tape
- Tape contains 10 stainless steel strands for high conductivity
- Includes: heavy duty insulated handle, 2 x Wood Post Pinlock Insulators, buckle, activator and 5 m of white/red Premium Gate Tape

Product code: 880 0013-087 (EA)

Tape Gate Hardware Kit



- For custom length gateways
- For use with Speedrite Premium Gate Tape
- Versatile and easy to install
- Fully insulated, heavy duty handle with protective guards and non-slip grip
- Includes: heavy duty insulated handle, 2 x Wood Post Pinlock Insulators, buckle and activator (excludes Tape)

Product code: 880 0013-083 (EA)

Spring Gate



- Electrifies gateways up to 8 m wide
- Versatile and easy to install
- Fully insulated, heavy duty handle with protective guards and non-slip grip
- Galvanised rust resistant spring
- Includes: heavy duty insulated handle, 2 x Wood Post Pinlock Insulators, activator and galvanised spring

Product code: 880 0013-088 (5 m EA)

880 0013-089 (8 m EA)

880 0013-075 (5 m replacement spring EA)

880 0013-076 (5 m replacement spring, yellow EA)

880 0013-073 (8 m replacement spring EA)

Spring Gate White



- Electrifies gateways up to 5 m wide
- Versatile and easy to install
- Fully insulated, heavy duty handle with protective guards and non-slip grip
- Galvanised rust resistant spring
- Includes: heavy duty insulated handle, 2 x Wood Post Pinlock Insulators, activator and 5 m white spring

Product code: 880 0013-090 EA

880 0013-072 (replacement spring, white EA)

Extreme Reflective Bungy Gate



- Includes reflective bungy for high visibility and safety across gateways.
- Electrifies gateways up to 11 m wide.
- Robust flat profile handle with strong stainless steel backbone for high conductivity and corrosion resistance.
- Versatile and easy to install.
- Includes: dual purpose gate handle, 2 x heavy duty wood post pinlock insulators, activator plate, galvanised hook, hi viz flag and reflective bungy.

Product code: 880 0013-191 EA (3.5 m - 7 m)

880 0013-192 EA (5.5 m - 11 m)

GATE KITS AND BUNGY CORD

Bungy Gate



- Electrifies gateways and races up to 11 m wide
- Versatile and easy to install
- Fully insulated handle with protective guards and non-slip grip
- Bungy Cord with 4 stainless steel strands provides extreme stretch, high conductivity and maximum shock exposure
- Includes: insulated handle, 2 x Wood Post Pinlock Insulators, activator, galvanised hook, High Visibility Flag and Bungy Cord

Product code: 880 0013-070 (3.5 mm - 7 mm EA)
880 0013-071 (5.5 mm - 11 mm EA)

Bungy Gate Hardware Kit



- For custom length gateways
- For use with Speedrite Premium Gate Tape
- Versatile and easy to install
- Fully insulated, heavy duty handle with protective guards and non-slip grip
- Includes: insulated handle, 2 x Wood Post Pinlock Insulators, activator, galvanised hook and High Visibility Flag (excludes Bungy Cord)

Product code: 880 0013-078 (EA)

Extreme Bungy Cord Reflective

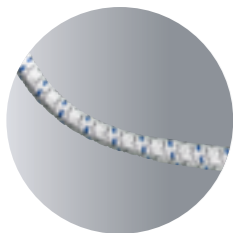

- Ideal for gateways and outriggers
- Durable multi-strand core and double sheath for long life
- Reflective strands for high visibility

Product code: 880 0013-175 (50m spool)

Premium Bungy Cord

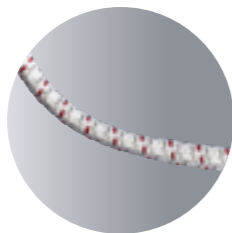

- Ideal for gateways and outriggers
- Durable multi-strand core and double sheath for long life

Product code: 880 0013-142 (50 m spool)
880 0013-143 (200 m spool)

Bungy Cord

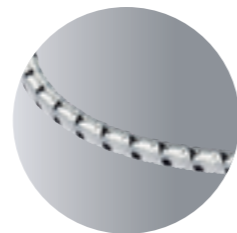

- Ideal for gateways and outriggers
- Polyester sheath for improved UV resistance
- Tightly braided to protect the core

Product code: 880 0013-043 (50m spool)

HANDLES

VERSATILE

Extreme Dual Purpose Handle

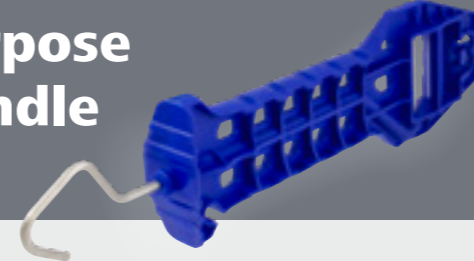

- Ideal for use in high traffic gateways
- Use as a live hook or an insulated hook in temporary fencing, or as a gate break handle
- Robust flat profile is less prone to damage
- Strong stainless steel backbone for high conductivity and corrosion resistance
- Versatile – fasten tape or bungy through the simple knot-free design
- Unique hook design enables a smooth and secure connection to an activator plate

Product code: 880 0013-080 (10 pack)
880 0013-081 (20 pack)

Gate Break Handle



- Non-slip insulated grip
- High density UV stabilised polyethylene for long life
- Replaceable heavy duty galvanised spring

Product code: 880 0000-368 (20 pack)
880 0013-065 (6 pack)
880 0001-310 (replacement spring, 10 pack)

Compression Gate Break Handle



- High tensile, heavy duty spring compresses under tension, preventing over-stretching
- Non-slip insulated grip
- High density UV stabilised polyethylene for long life
- Heavy duty, rugged body with large protective guards

Product code: 880 0000-330 (blue, 20 pack)
880 0000-798 (white, 20 pack)

Heavy Duty Gate Break Handle

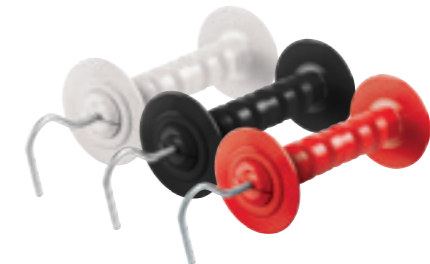

- Heavy duty, rugged body with large protective guards
- Non-slip insulated grip
- High density UV stabilised polyethylene for long life
- High tensile galvanised spring

Product code: 880 0013-176 (white, 20 pack)
880 0013-177 (black, 20 pack)
880 0000-483 (red, 20 pack)

ZAMMR Handle



- Convenient, multi-purpose handle
- Use as a live hook or an insulated hook in temporary fencing, or as a gate break handle
- Versatile - connect temporary fence, wire, tape or bungy
- Strong stainless steel backbone for high conductivity and corrosion resistance
- Single piece over-mould ensures a fully insulated handle
- Durable design for use in the toughest conditions

Product code: 880 0013-077 (10 pack)
880 0013-079 (30 pack)

OTHER GATE PRODUCTS

Gate Activator



- For use with tape, spring and bungy gates
- 3 connection points for flexibility

Product code: 880 0013-084 (10 pack)

No Kick Handle



- Used when an insulated connection is required
- Strong UV resistant design
- For use in temporary fence application
- Slim design for ease of use

Product code: 880 0013-082 (10 pack)

Activator and Gate Anchor



- For use with tape, spring and bungy gates
- 3 connection points for flexibility

Product code: 880 0013-066 (5 pack)

Wood Post Gate Anchor Insulator



- Economical option for building a gate between wood posts
- For use on wood posts
- Suitable for use with poliwire, poliropo, steel/aluminum wire

Product code: 880 0013-373 (4 pack)

Safety Flag



- For use on any gateway including tape, spring or bungy

Product code: 880 0013-116 (yellow, 10 pack)

**Want to learn
about Datamars
Livestock solutions and
products in an easy,
accessible way?**



Join our FREE Datamars Livestock Training Academy

Courses are short and available 24/7.
Work at your own pace and share your certificate on LinkedIn when you're done!

Register online at academy.livestock.datamars.com

HAYES™

Fence Tools



In 1895 a young pioneer Ernest Hayes began farming the rugged back country of New Zealand's South Island and through his background in engineering, soon began to develop the tools that would help turn this wilderness back country into productive land.

Initially produced by hand, Hayes' simple tools began to develop a solid reputation and in 1902 he established the company that would proudly bear his name. Times have changed, but the Hayes product you buy today remains a tribute to Ernest Hayes' imagination, drive, energy and determination to be the best. Now 125 years on, Hayes products can be found hard at work in Australia and over 25 countries around the world.

Wire Strainers

Smooth Grip Chain Strainer

Product code: H300 (880 0000-015)

The original chain and grab wire strainer. Proven in the field for over 100 years.

- Heavy duty industry leader
- Available with anchor hook and extra long chain H300AL (800009)

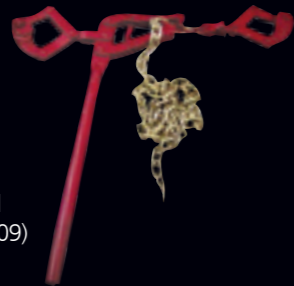

Steel Strainer Clamps

Product code: H508S 1.2 m (880 0000-028)
H508S 1.9 m (880 0000-045)
H508S 2.4 m (880 0000-011)

- Hammer-in wedges for quick easy operation
- Strain up using H406 Clamp Strainer



Clamp Strainer

Product code: H406 (880 0000-063)

- Designed for use with prefabricated fence
- For use with Steel Strainer Clamps



Tightening Handle

Product code: H303 (880 0000-133)

- Used in conjunction with permanent wire strainers to tighten fence wire



Permanent Wire Strainer

Product code: H302 (880 0000-132)

- The original ratchet wire strainer
- Superior load capacity
 - Famous for strength



Wire Dispensers

Adjustable-Collapsible Wire Dispenser

Product code: H540 Spike Foot (880 0000-019)

- Folding arms for ease of storage
- Adjustable to all wire coil diameters

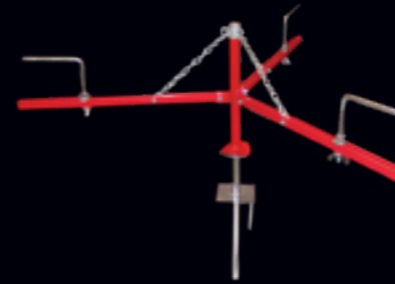

Deluxe Wire Dispenser

Product code: H320 (880 0000-112)

- Spring adjusted tension brake to control over-run
- Anchor pin for ground holding
- Coiling handle for recoiling fence wire



ProCrimp & Crimp Sleeves

ProCrimp

Product code: (880 0000-123)

4-in-1 fencing tool - crimping tool, staple puller, cable stripper, and wire cutter.

Hardened steel for long life

- Hardened stainless steel components provide strength and corrosion resistance
- Double action crimping jaws maximise crimping force and enhance locking action for gripping staples
- Flat head jaws give improved stability when removing staples
- Extra long handles for improved crimping power and greater leverage for removing staples



Crimp Sleeves

Product code: H386AP (880 0000-062)

The easiest and most effective means of joining wire. Creates a joint that exceeds the breaking strength of wire.

- HC2**
 - Suitable for \varnothing 1.6 - 2.5mm (16 - 12½ gauge) fence wire
 - Pot of 100 (880 0000-124)
- HC3**
 - Suitable for \varnothing 2.5 - 3.15mm (12½ - 10 gauge) fence wire
 - Pot of 50 (880 0000-090)
- HC4**
 - Suitable for \varnothing 3.55 - 4mm (9 - 8 gauge) fence wire
 - Pot of 50 (880 0000-105)
- HCB**
 - Suitable for barbed wire
 - Pot of 50 (880 0000-034)
- HCE**
 - Suitable for connection to electric fences
 - Pot of 50 (880 0000-052)
- FASTLOCK™**
 - Reusable wire connector
 - Pot of 10 (880 0002-099)



Fence Post Tools

Round Head Fencing Spade

Product code: H349 1.12 m (880 0001-988)

- Hardened steel for long life
- Double curvature head allows greater dirt removal



Post Hole Rammer

Product code: H386AP (880 0000-062)

- Steel handle with cast iron foot makes compaction easy
- Half round head to suit any application



SUPPORT MERCHANDISING

Catalogues



Full range catalogue, available in multiple languages.

Dimensions: 190mm x 127mm x 162mm

Product code: 600 0200-412 (English)

Leaflets



DL trifold leaflets focusing on the Solar Energizer and grazing kits or showcasing the key products across the full range.

Dimensions: Folded: 99mm x 210mm

Available upon request

Product Bin



A display box for larger items such as fence posts.

Dimensions: Height: 1000mm Width: 500mm

Product Code: 600 0200-423

Product box



Dimensions: Medium Box: 296L x 208W x 100H x 40F Large Box: 390L x 285W x 200H x 70F

Product Codes: Medium Box: 600 0200-424 Large Box: 600 0200-425

Branded Cubes



Dimensions: 350mm x 350mm

Available upon request

Pull Up Banners



Multiple Designs Available.

Available upon request

Fabric Flags



Fabric beach flags

Dimensions: 690mm x 2590mm

Available upon request

SUPPORT MERCHANDISING

Store Header Boards

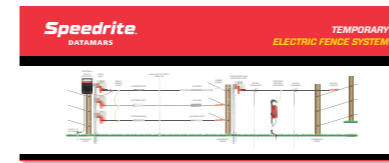

Dimensions: 980mm x 395mm Available upon request

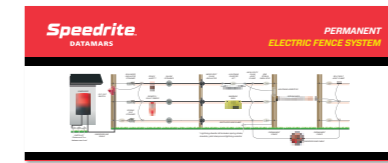

Dimensions: 980mm x 395mm Available upon request



Dimensions: 1200mm x 300mm Product Code: 600 0200-420

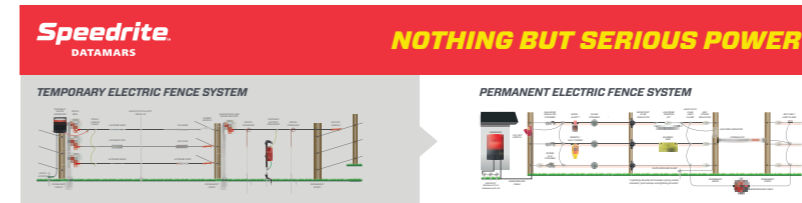

Available upon request Dimensions: 1200mm x 300mm

We have set sizes of header boards you can order, however we can also create custom sizes to fit your store on request.

Extras

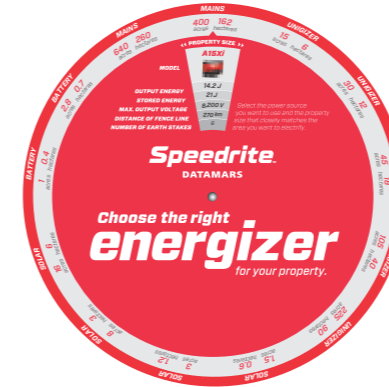

NEU Speedrite Energizer Decision Wheel

Available upon request



NEU Speedrite Sword Stick (Grass Check - GB)

Available upon request

Shelf Wobblers



Key Product wobbler's, plus warranty extension wobbler's available through request.

Dimensions: 690mm x 2590mm

Available upon request

Shelf Strips



Available upon request



Available upon request

Dimensions: 1000mm x 40mm. These can be made to specific sizes on request.

DATAMARS *Livestock*

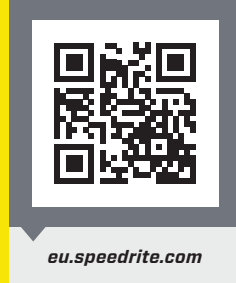

eu.speedrite.com

***To view this catalogue in other languages,
scan the codes below.***

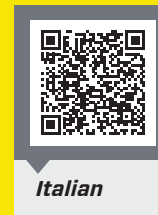
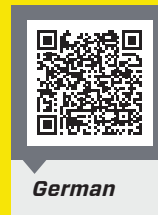
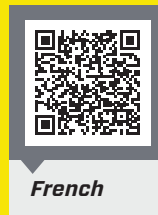
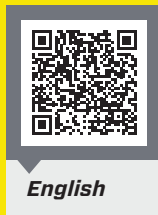

Z
TAGS
DATAMARS

Simcro.
DATAMARS

njphillips.
DATAMARS

Tru-Test.
DATAMARS

Prattley
DATAMARS

Speedrite.
DATAMARS

HAYES
DATAMARS

Get in touch: info@eu.speedrite.com

www.eu.speedrite.com

Although the information presented in this Product Catalogue is believed to be accurate and reliable, no responsibility for inaccuracies can be assumed by Datamars Limited. Performance data is typical only and variations due to component manufacturing tolerances and operating conditions are normal. Datamars reserves the right at any time to change performance characteristics or specifications without prior notice. © Datamars 2021 – All rights reserved.